

- EN** Artery Forceps
- DE** Arterienklemmen
- ES** Pinzas hemostáticas

Page 117 to 157

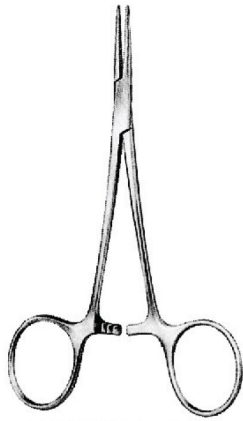



HALSTED-MOSQUITO

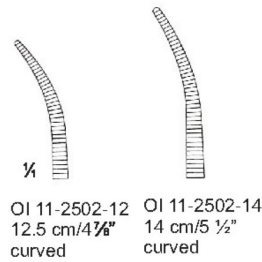
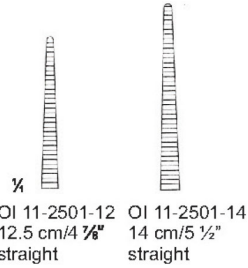

HALSTED-MOSQUITO

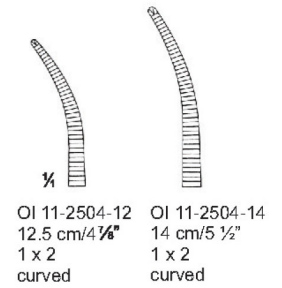
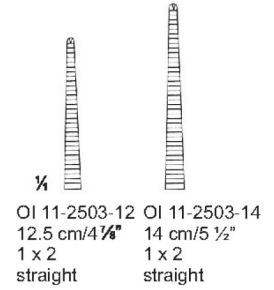

ATRAUMA

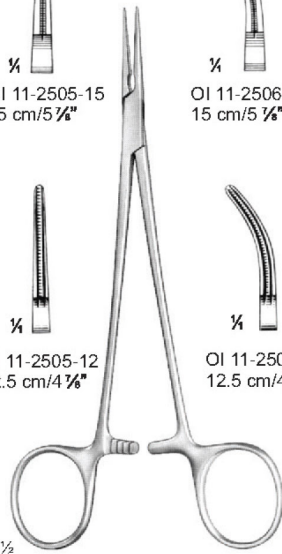
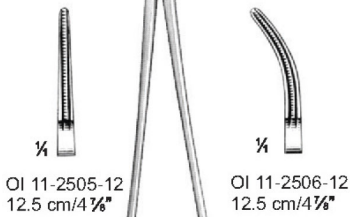
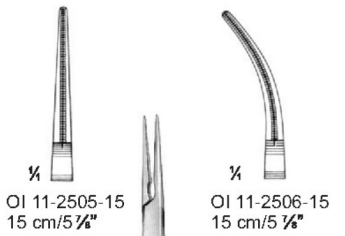

DEBAKEY-MOSQUITO

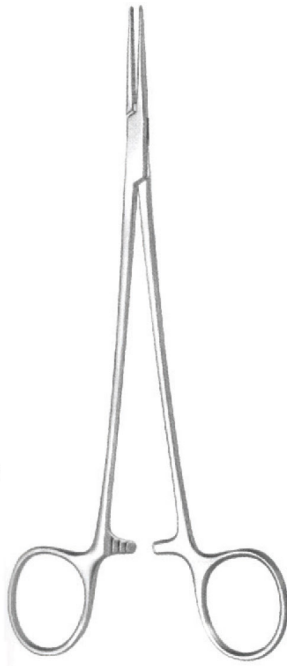

HALSTED-MOSQUITO

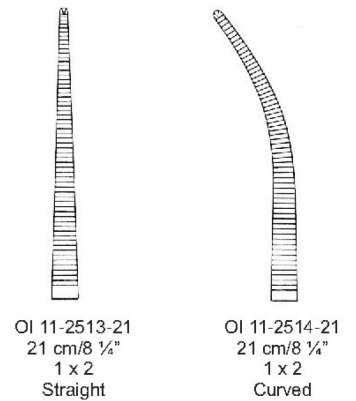
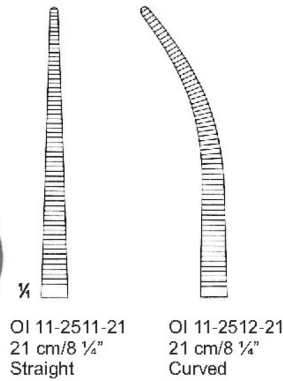
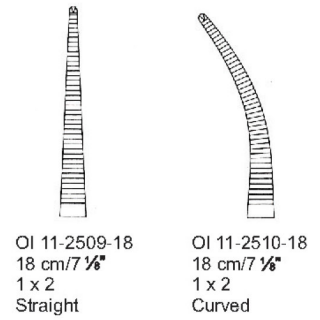
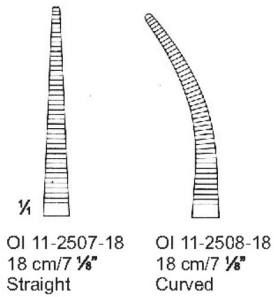

ARTERY FORCEPS

Haemostatic Forceps — EN
 Arterienklemmen — DE
 Pinzas hemostáticas — ES

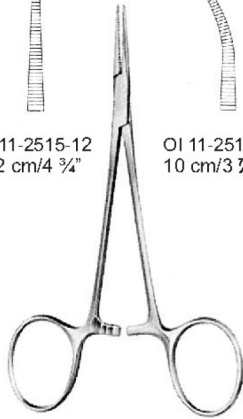
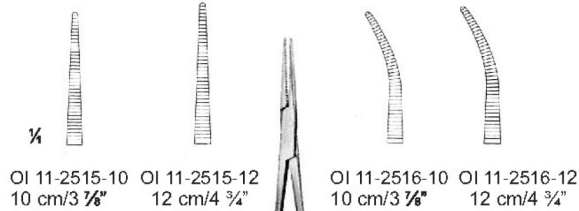

MICRO-MOSQUITO

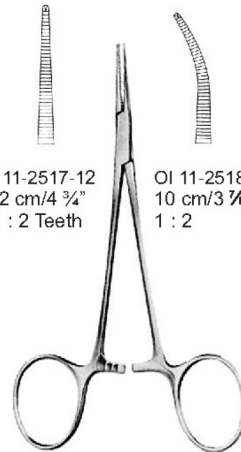
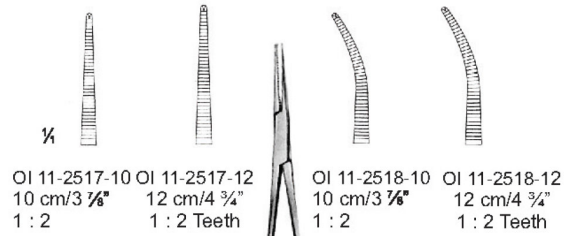

MICRO-MOSQUITO

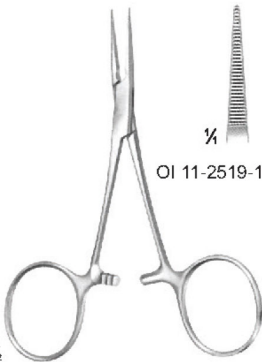
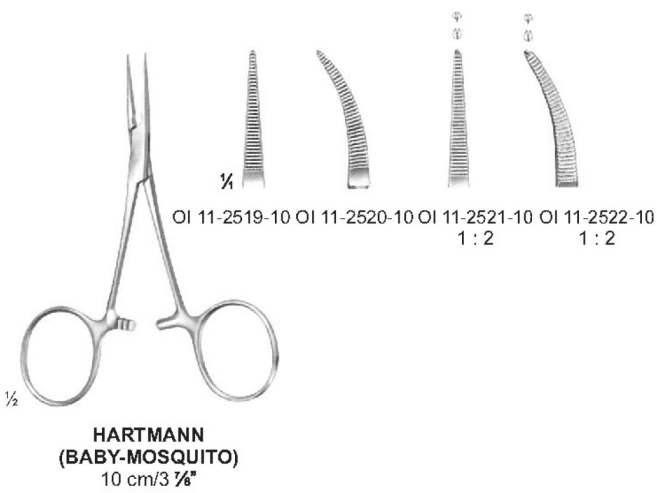

HARTMANN (BABY-MOSQUITO)
 10 cm/3 7/8"



CARREL
 OI 11-2523-08
 8.5 cm/3 3/8"

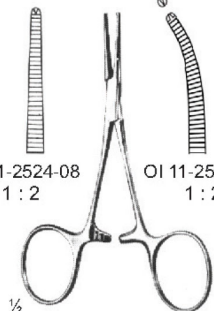
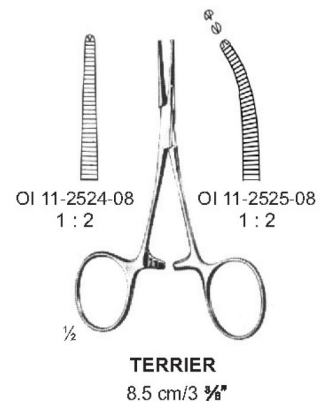

TERRIER
 8.5 cm/3 3/8"



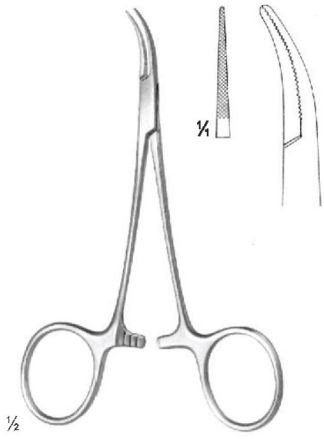

MOSQUITO-DANDY
OI 11-2526-12
12 cm/4 3/4"



DANDY
14 cm/5 1/2"

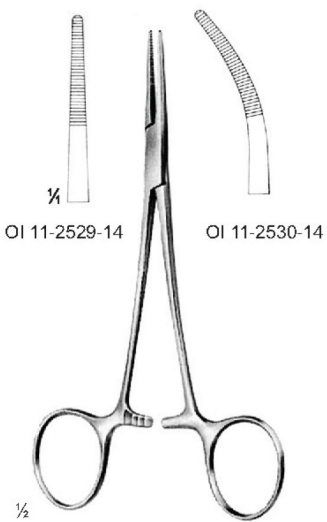
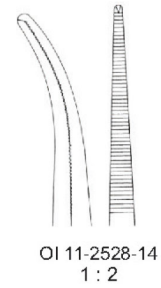
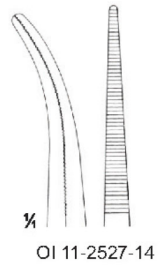

PROVIDENCE-HOSPITAL
14 cm/5 1/2"

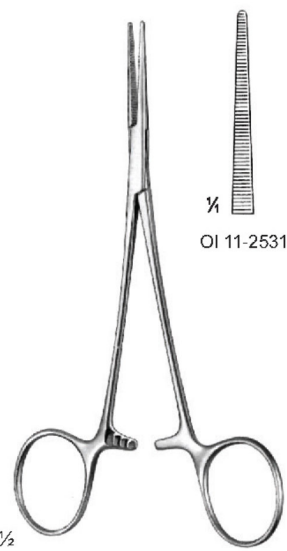

LERICHE
15 cm/5 3/4"

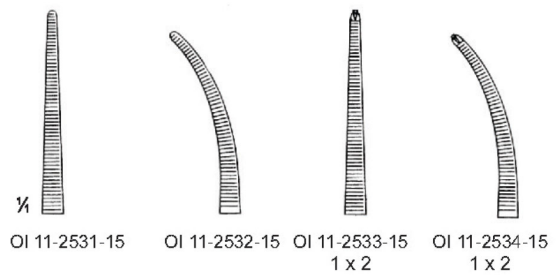
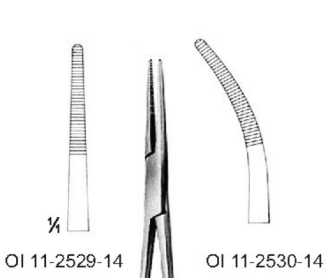

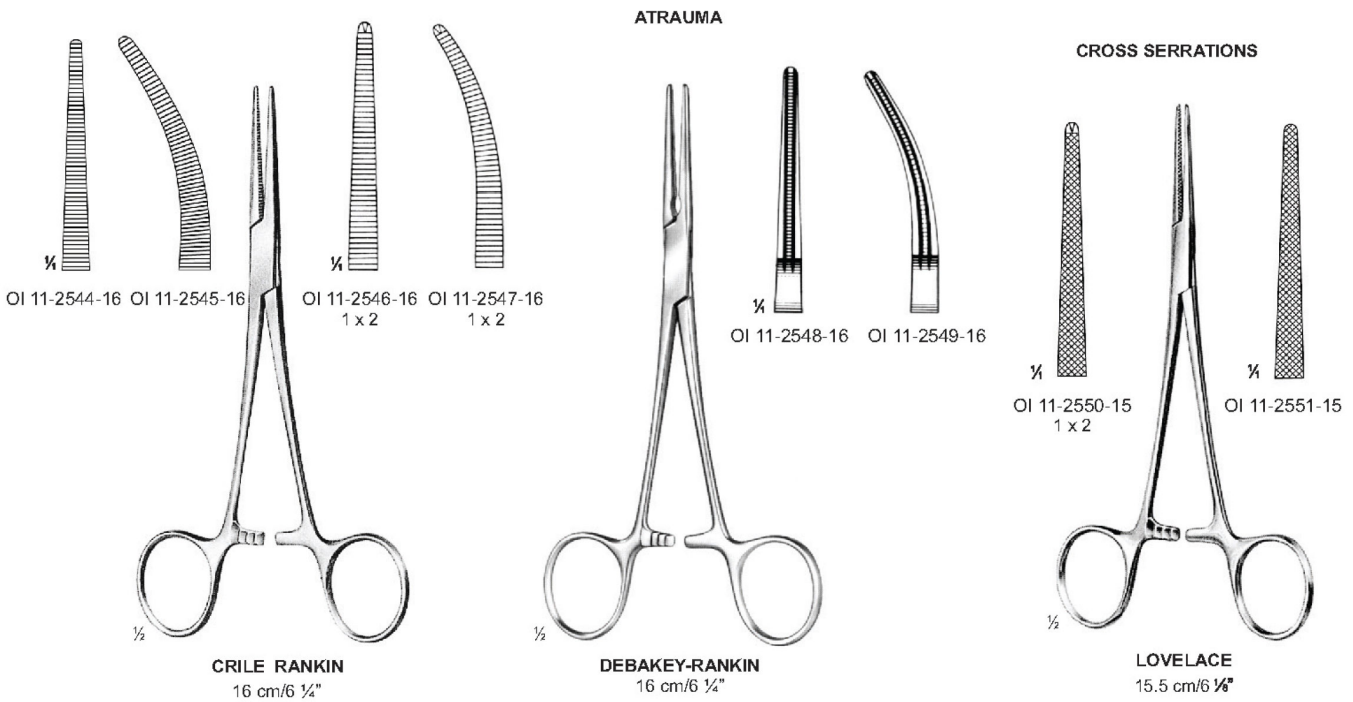
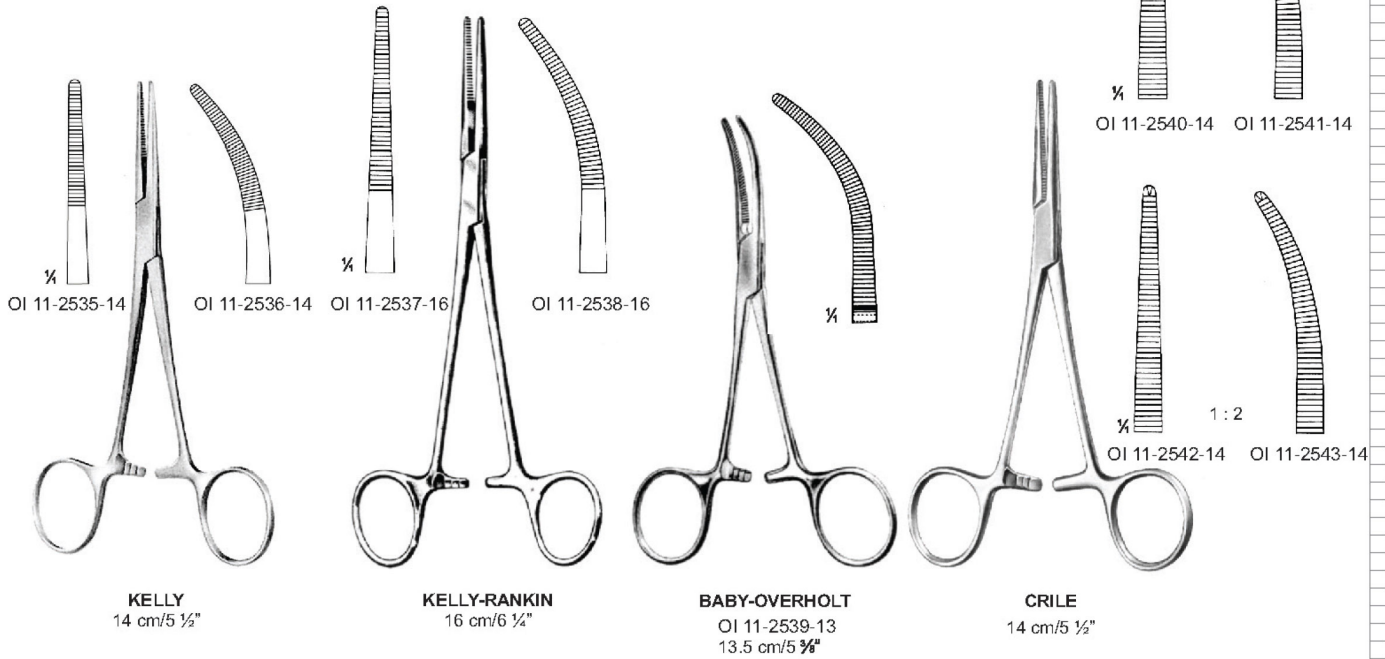



SPENCER-WELLS/JONES



OI 11-2552-13
13 cm/5 1/8"



OI 11-2552-14
14.5 cm/5 3/4"



OI 11-2552-15
15.5 cm/6 1/8"



OI 11-2552-18
18.5 cm/7 1/4"



OI 11-2552-20
20 cm/7 7/8"



OI 11-2553-13
13 cm/5 1/8"



OI 11-2553-14
14 cm/5 1/2"



OI 11-2553-15
15 cm/5 7/8"



OI 11-2553-18
18 cm/7 1/8"

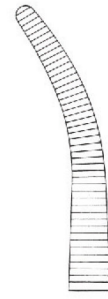

OI 11-2553-20
20 cm/7 7/8"



OI 11-2554-13
13.5 cm/5 3/8"



OI 11-2554-14
14.5 cm/5 3/4"



OI 11-2554-17
17 cm/6 3/4"



OI 11-2555-13
13 cm/5 1/8"



OI 11-2555-14
14 cm/5 1/2"



OI 11-2555-16
16.5 cm/6 1/2"

Cm	In	Straight
18	7 1/8"	OI 11-2557-18
20	7 7/8"	OI 11-2557-20
22	8 1/2"	OI 11-2557-22
24	9 1/2"	OI 11-2557-24
26	10 1/4"	OI 11-2557-26
28	11"	OI 11-2557-28

Cm	In	Curved
18	7 1/8"	OI 11-2558-18
20	7 7/8"	OI 11-2558-20
22	8 1/2"	OI 11-2558-22
24	9 1/2"	OI 11-2558-24
26	10 1/4"	OI 11-2558-26
28	11"	OI 11-2558-28

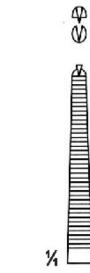

OI 11-2559-18
1 x 2

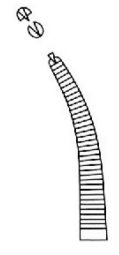

OI 11-2560-18
1 x 2

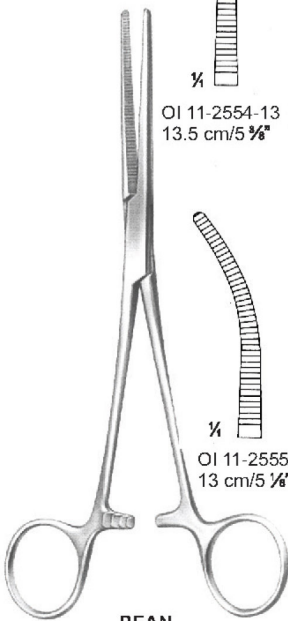

PEAN
DELICATE PATTERN

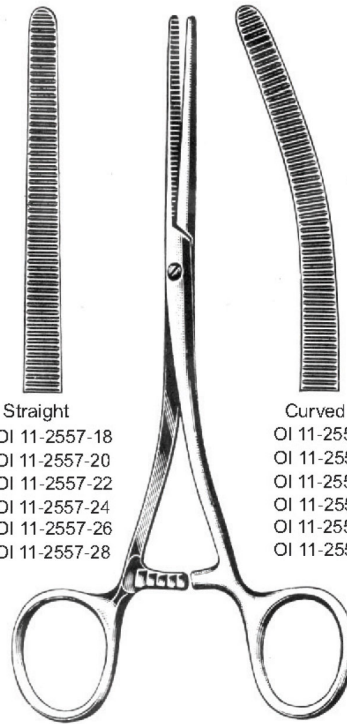

PEAN

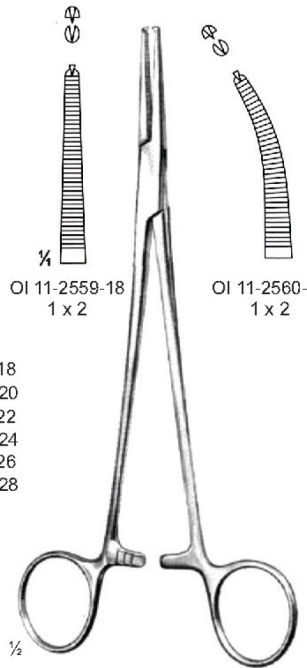

ADSON
18.5 cm/7 1/4"



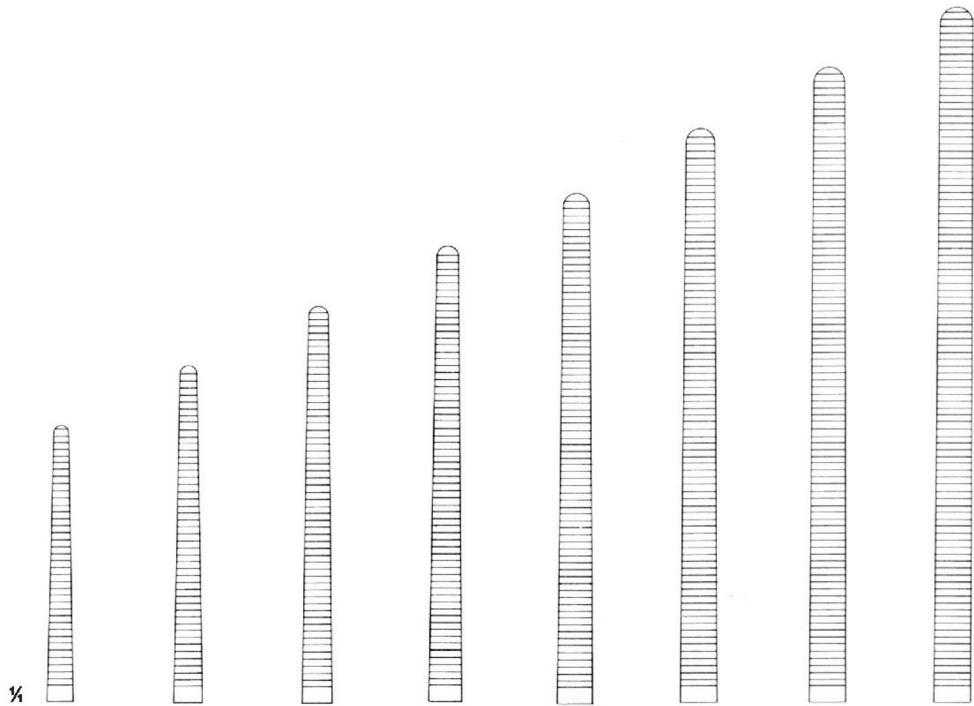

OI 11-2561-14 14.5 cm/5 3/4" OI 11-2561-16 16.5 cm/6 1/2" OI 11-2561-18 18.5 cm/7 1/4" OI 11-2561-20 20.5 cm/8 1/8" OI 11-2561-22 22.5 cm/8 3/4" OI 11-2561-24 24.5 cm/9 5/8" OI 11-2561-26 26 cm/10 1/4" OI 11-2561-30 30.5 cm/12"



ROCHESTER-PEAN

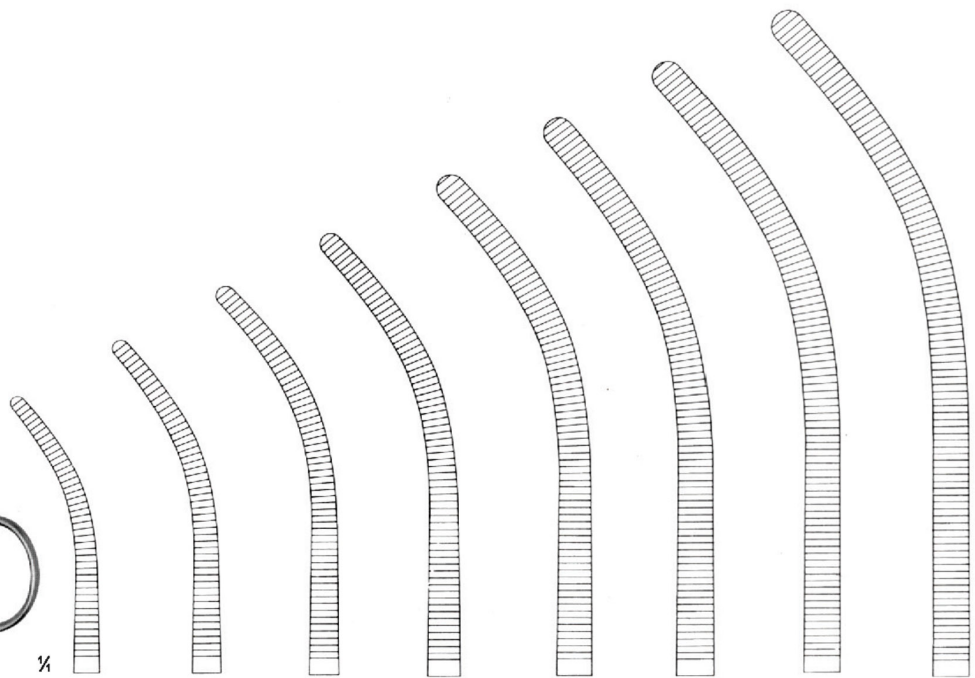

OI 11-2562-14 14.5 cm/5 3/4" OI 11-2562-16 16.5 cm/6 1/2" OI 11-2562-18 18.5 cm/7 1/4" OI 11-2562-20 20.5 cm/8 1/8" OI 11-2562-22 22.5 cm/8 3/4" OI 11-2562-24 24.5 cm/9 5/8" OI 11-2562-26 26 cm/10 1/4" OI 11-2562-30 30.5 cm/12"



ATRAUMA

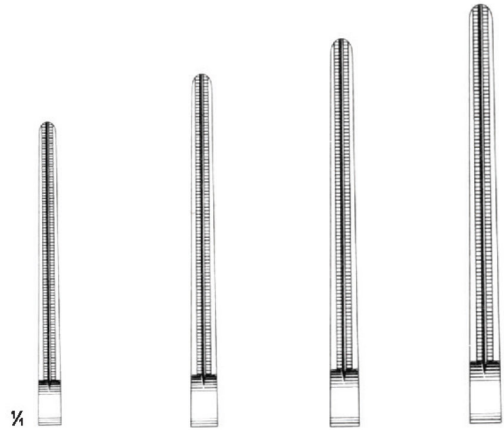
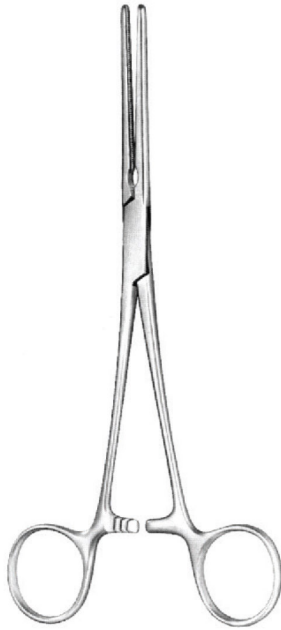

- OI 11-2563-14 14.5 cm/5 3/4"
- OI 11-2563-16 16.5 cm/6 1/2"
- OI 11-2563-18 18.5 cm/7 1/4"
- OI 11-2563-20 20.5 cm/8 1/8"

DEBAKEY-PEAN

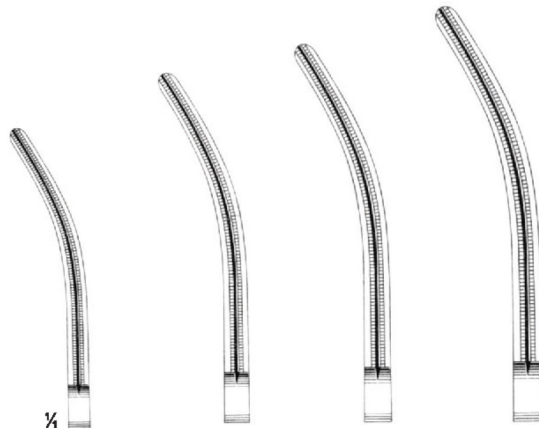

- OI 11-2564-14 14.5 cm/5 3/4"
- OI 11-2564-16 16.5 cm/6 1/2"
- OI 11-2564-18 18.5 cm/7 1/4"
- OI 11-2564-20 20.5 cm/8 1/8"

DEBAKEY-PEAN

ARTERY FORCEPS

Haemostatic Forceps ● EN
 Arterienklemmen ● DE
 Pinzas hemostáticas ● ES

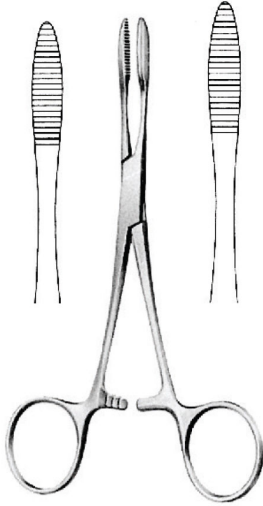

PEAN
 OI 11-2565-14 14 cm/5 1/2"
 OI 11-2565-16 16 cm/6 1/4"



KOCHER
 Delicate Pattern
 1 : 2

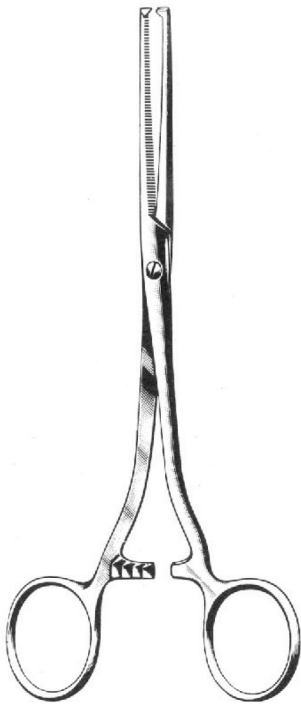
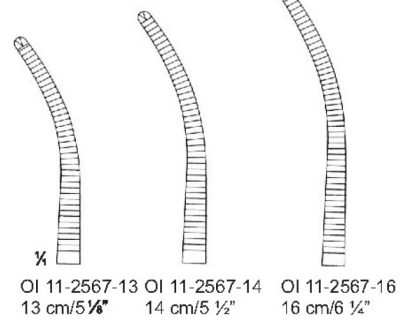
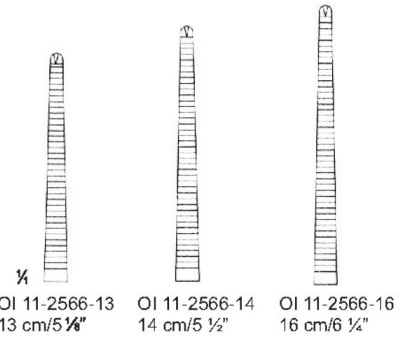

KOCHER

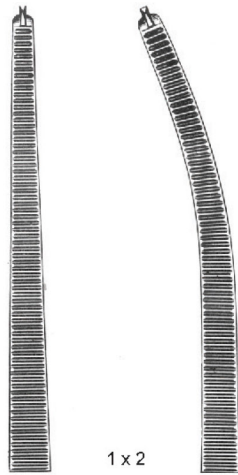

OI 11-2568-18 18 cm/7 1/8"
 OI 11-2568-20 20 cm/7 7/8"
 OI 11-2568-22 22 cm/8 1/2"
 OI 11-2568-24 24 cm/9 1/2"
 OI 11-2568-26 26 cm/10 1/4"
 OI 11-2569-18
 OI 11-2569-20
 OI 11-2569-22
 OI 11-2569-24
 OI 11-2569-26

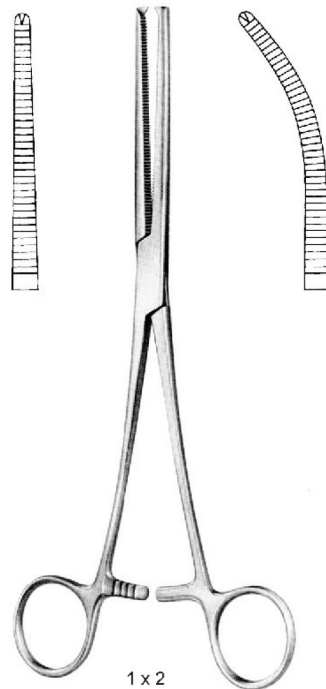

KOCHER (STANDARD)
 OI 11-2570-13 13 cm/5 1/8"
 OI 11-2570-14 14 cm/5 1/2"
 OI 11-2571-14 14.5cm/5 3/4"
 OI 11-2572-13
 OI 11-2572-14
 OI 11-2573-14



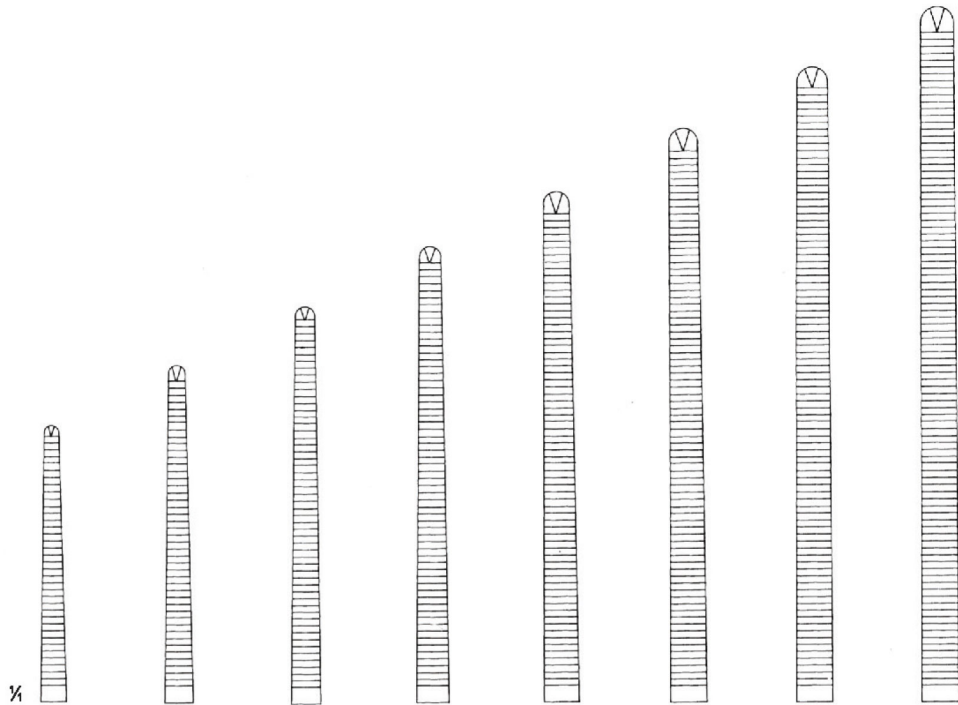

OI 11-2574-16 16 cm/6 1/4" OI 11-2574-18 18 cm/7 1/8" OI 11-2574-20 20 cm/7 7/8" OI 11-2574-22 22 cm/8 1/2" OI 11-2574-24 24 cm/9 1/2" OI 11-2574-26 26 cm/10 1/4" OI 11-2574-28 28 cm/11" OI 11-2574-30 30 cm/11 3/4"



KOCHER OCHSNER
1 : 2

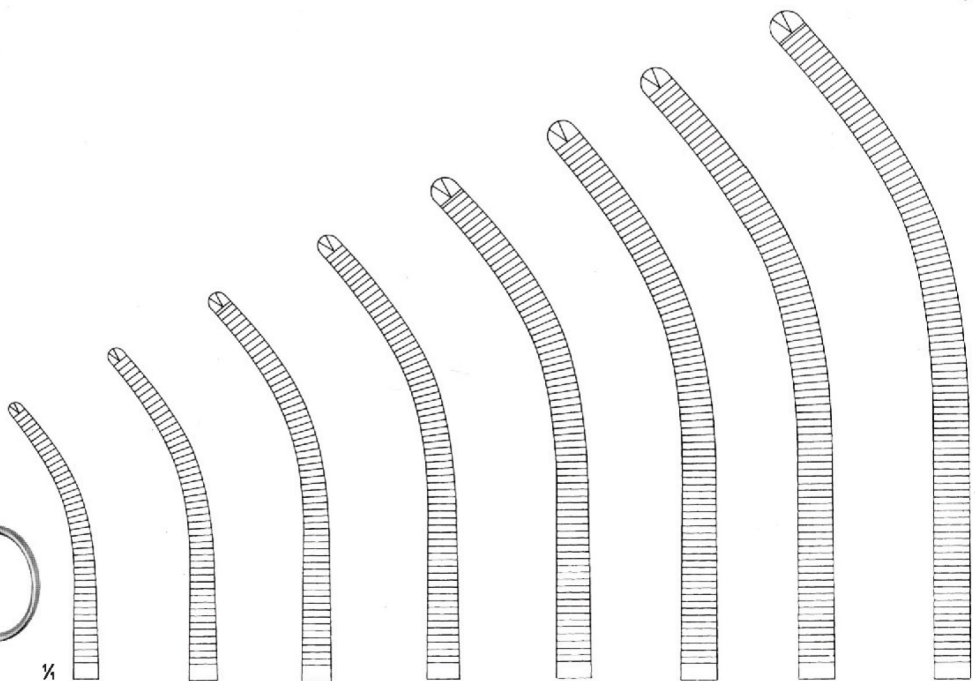

OI 11-2575-16 16 cm/6 1/4" OI 11-2575-18 18 cm/7 1/8" OI 11-2575-20 20 cm/7 7/8" OI 11-2575-22 22 cm/8 1/2" OI 11-2575-24 24 cm/9 1/2" OI 11-2575-26 26 cm/10 1/4" OI 11-2575-28 28 cm/11" OI 11-2575-30 30 cm/11 3/4"

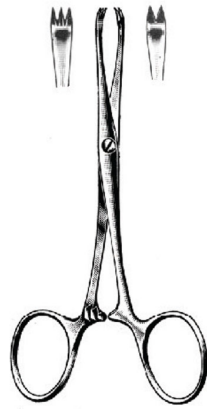

CHAPUT
 OI 11-2576-13
 13 cm/5 1/8"

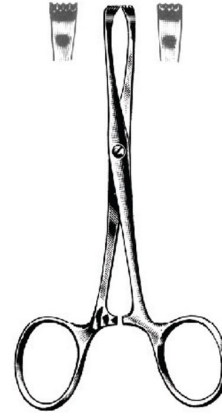

TUFFIER
 OI 11-2577-13
 13 cm/5 1/8"

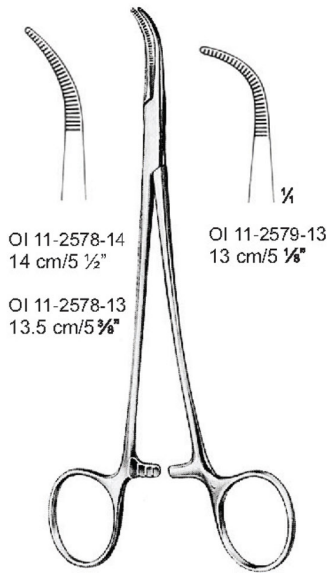

OI 11-2578-14
 14 cm/5 1/2"

OI 11-2579-13
 13 cm/5 1/8"

OI 11-2578-13
 13.5 cm/5 3/8"

BABY-MIXTER

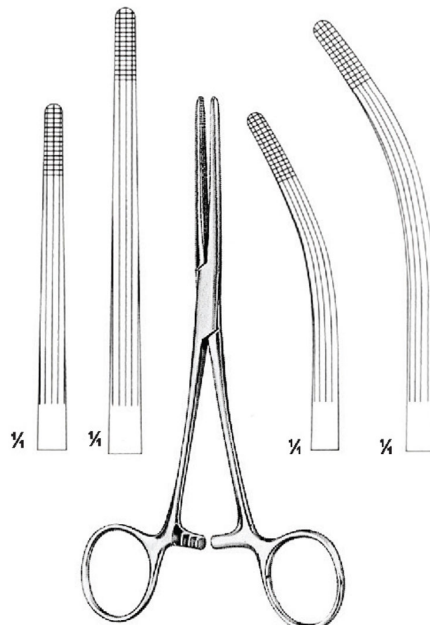

ROCHESTER-CARMALT
 OI 11-2580-16 16 cm/6 1/4" OI 11-2581-16
 OI 11-2580-20 20 cm/7 1/8" OI 11-2581-20

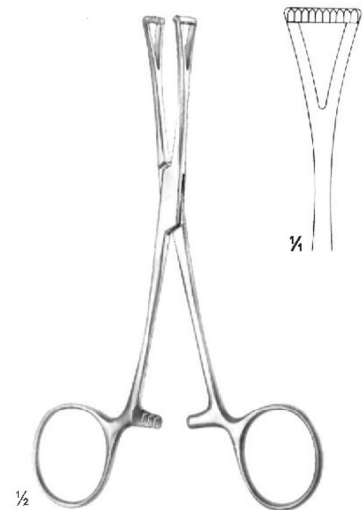

COLLIN
 OI 11-2582-14
 14 cm/5 1/2"





BIRKET
18.5 cm / 7 1/4"

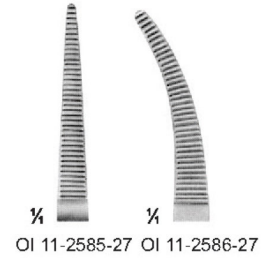
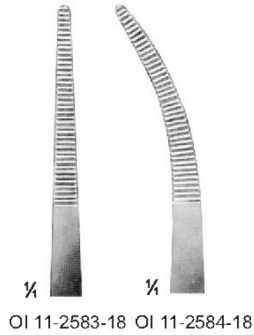

BENGOLEA

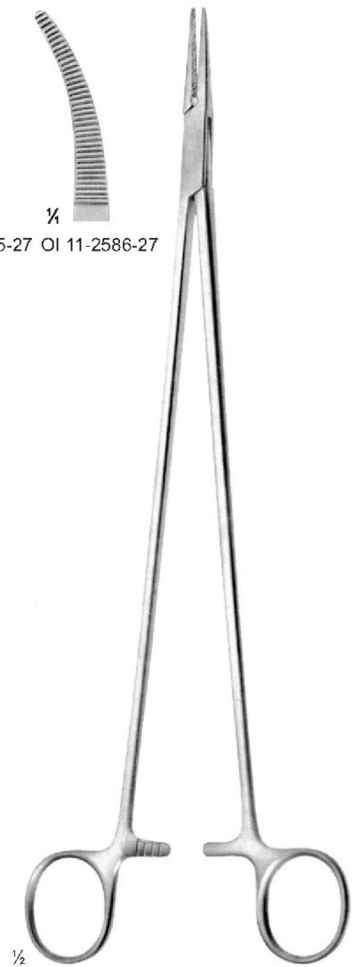
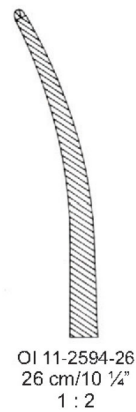
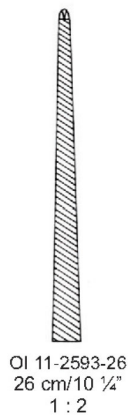
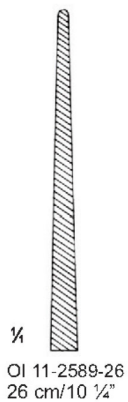
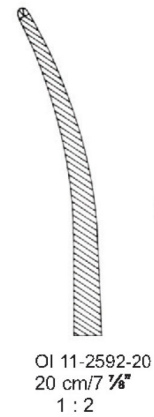
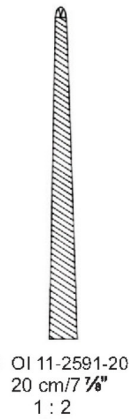
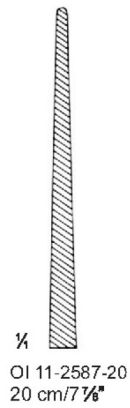

BRIDGE
27.5 cm / 10 3/4"



Pressure Clamps, Haemorrhoidal Clamps
 Druckklemmen, Hämorrhoidenklemmen
 Pinza de presión progresiva, Pinza-Clamps para hemorroides

EN
 DE
 ES

ARTERY FORCEPS



PENNINGTON
 OI 11-2595-15 15.5 cm/6 1/8"
 OI 11-2595-20 20 cm/7 7/8"

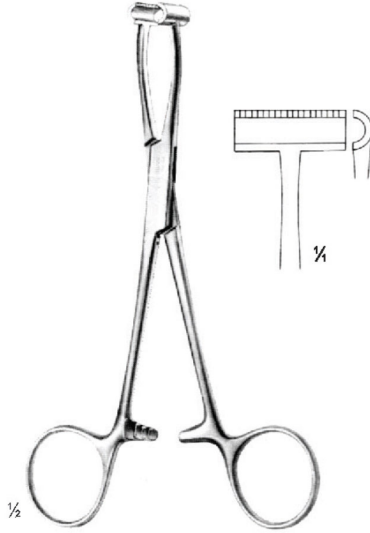

PRATT
 OI 11-2596-15
 15 cm/5 7/8"

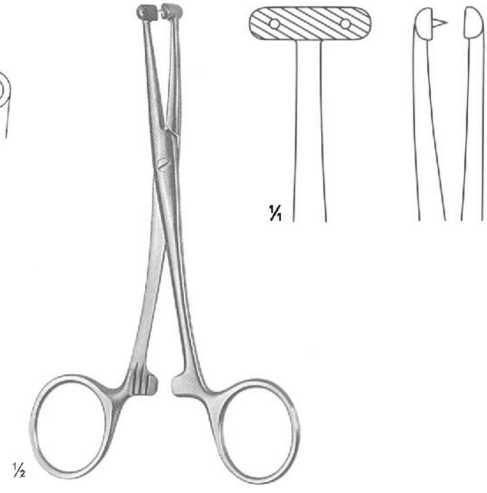

MARTEL
 OI 11-2597-14
 14 cm/5 1/2"



WILLET-MARTEL
 OI 11-2598-19
 19 cm/7 1/2"

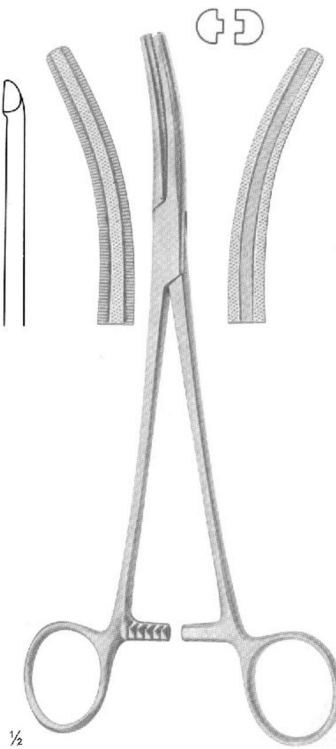

BUIE
 OI 11-2599-21
 21 cm/8 1/4"

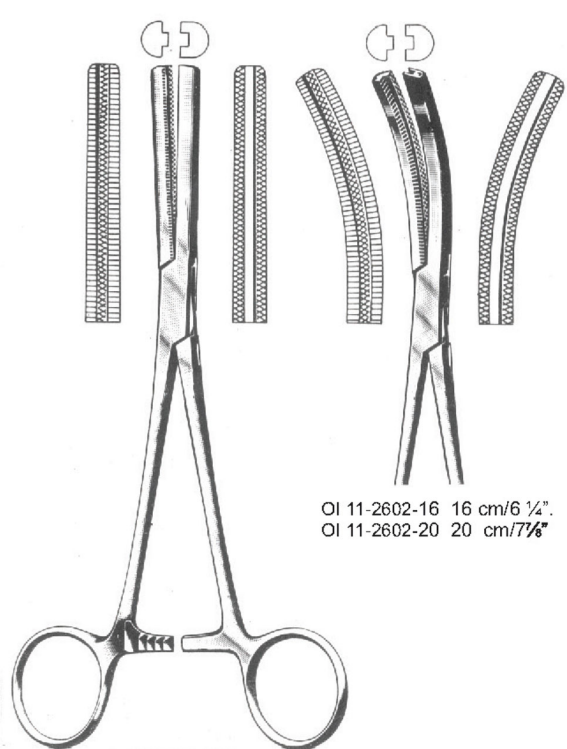

FERGUSSON
 OI 11-2600-16 16 cm/6 1/4"
 OI 11-2600-20 20 cm/7 7/8"

OI 11-2602-16 16 cm/6 1/4"
 OI 11-2602-20 20 cm/7 7/8"



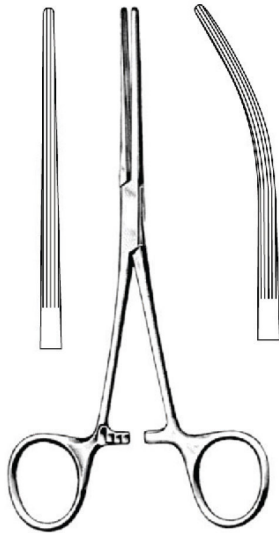

BAINBRIDGE

OI 11-2603-15 15 cm/5 7/8" OI 11-2604-15
 OI 11-2603-18 18.5 cm/7 1/4" OI 11-2604-18

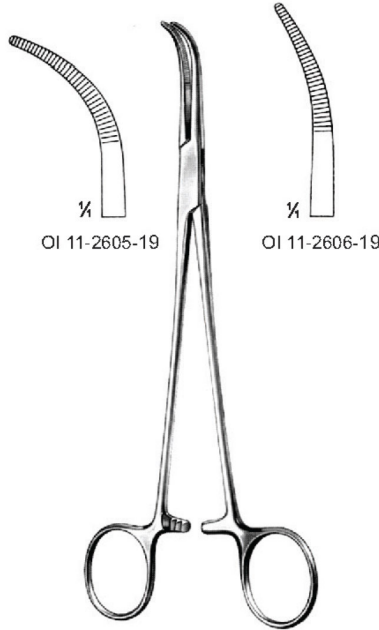

SCHNIDT

19 cm/7 1/2"

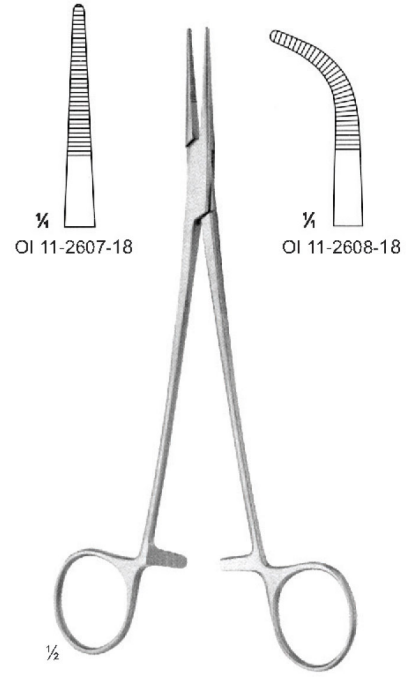

ADSON

18.5 cm/7 1/4"

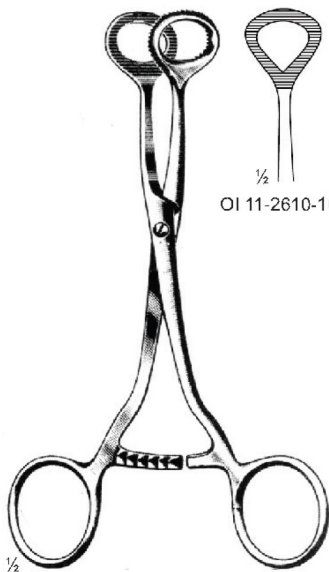

COLLIN

OI 11-2609-16
 16 cm/6 1/4"

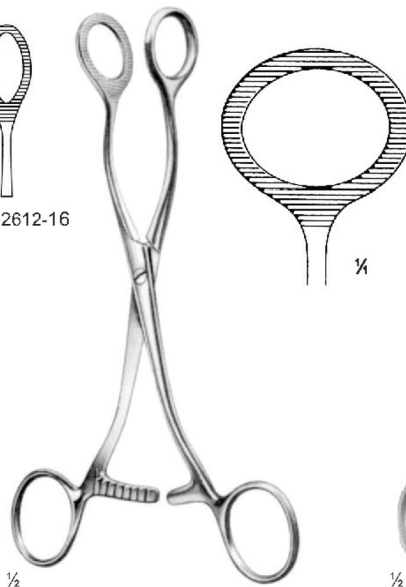

COLLIN

OI 11-2613-16
 16.5 cm/6 1/2"

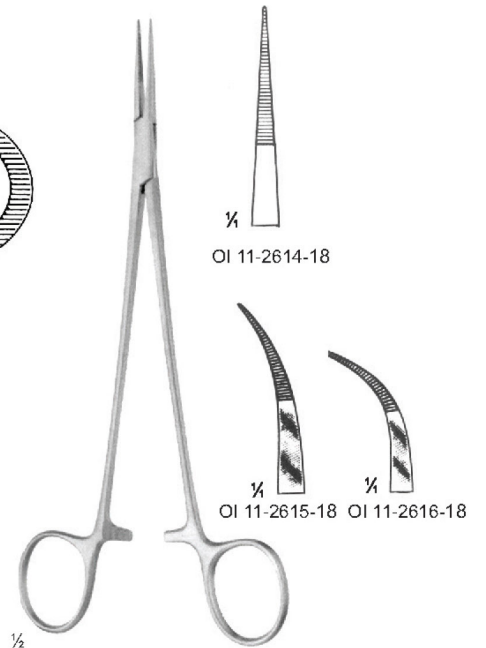

JACOBSON-MICRO

18 cm/7 1/8"





BABY-MIXTER
 OI 11-2617-18
 18 cm/7 1/8"



MICRO-ADSON
 OI 11-2618-14
 14 cm/5 1/2"

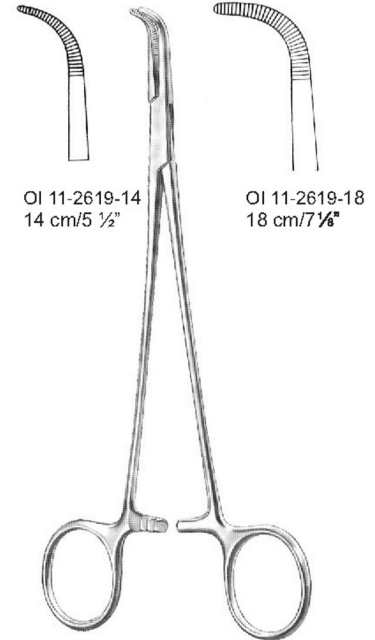

OI 11-2619-14
 14 cm/5 1/2"

OI 11-2619-18
 18 cm/7 1/8"

ADSON-BABY

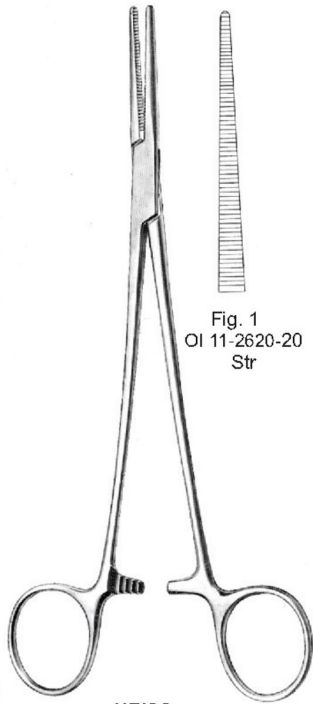

HEISS
 20 cm/7 7/8"

Fig. 1
 OI 11-2620-20
 Str

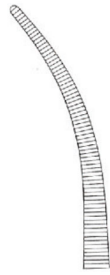
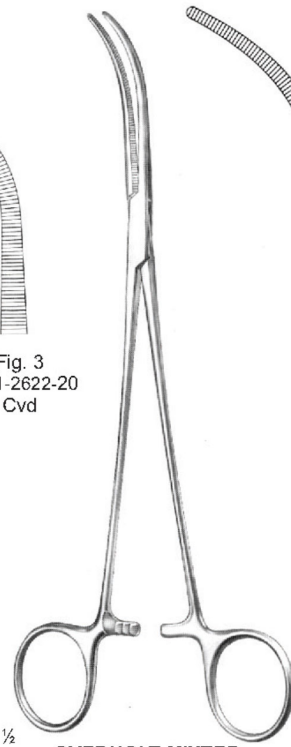

Fig. 2
 OI 11-2621-20
 Slightly Cvd



Fig. 3
 OI 11-2622-20
 Cvd



OVERHOLT-MIXTER
 OI 11-2623-21
 21 cm/8 1/4"

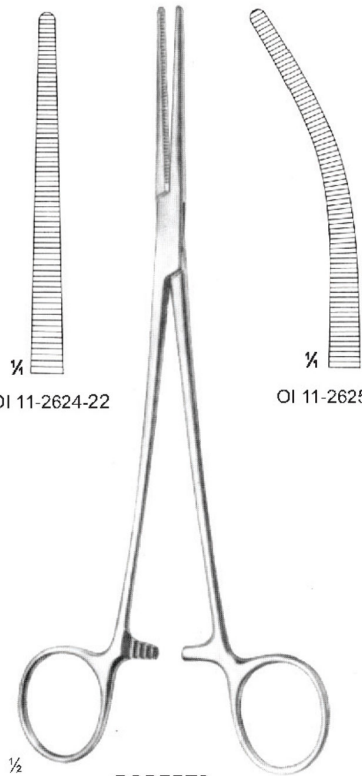

ROBERTS
 22 cm/8 1/2"

OI 11-2624-22

OI 11-2625-22



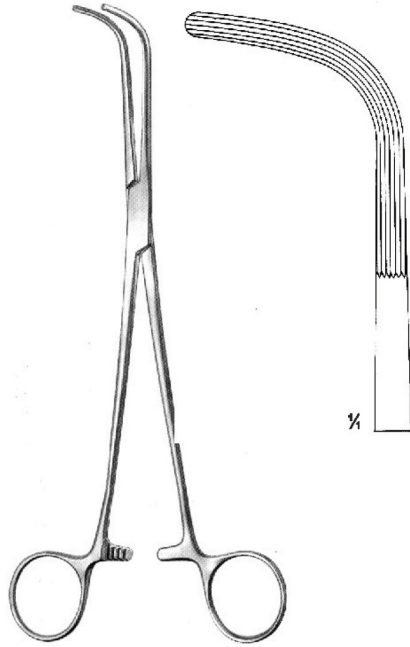

MCQUIGG-MIXTER
 OI 11-2626-23
 23.5 cm/9 1/4"

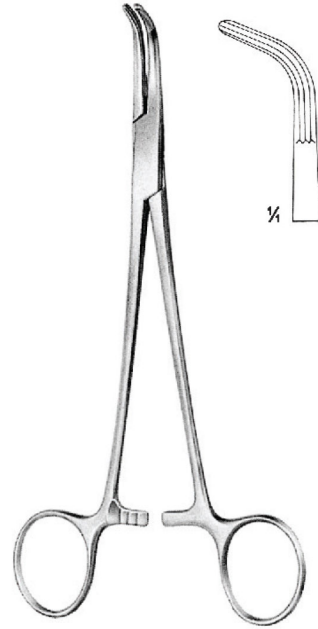

LAHEY
 OI 11-2627-18
 18.5 cm/7 1/4"



LAHEY

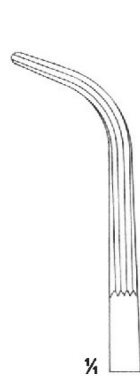

OI 11-2628-19
 19.5 cm/7 1/2"

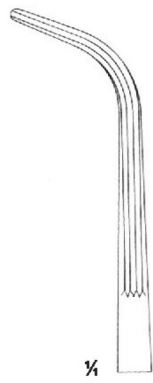

OI 11-2629-22
 22.5 cm/8 3/4"

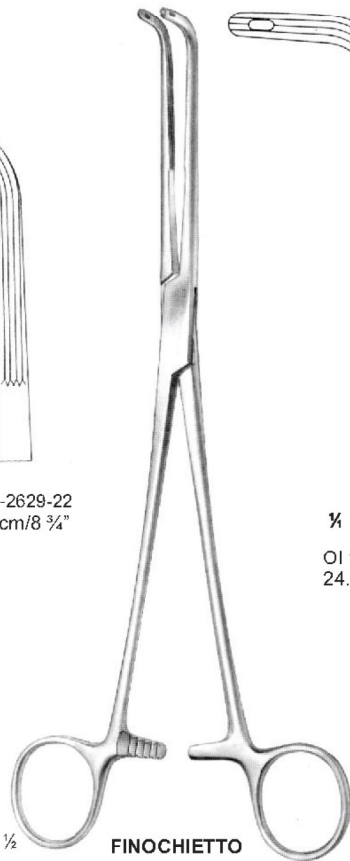

FINOCHIETTO

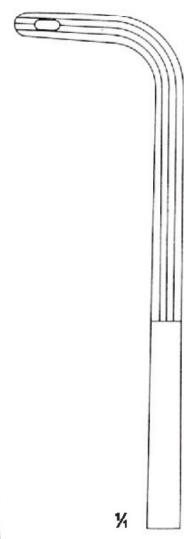

OI 11-2630-24
 24.5 cm/9 5/8"

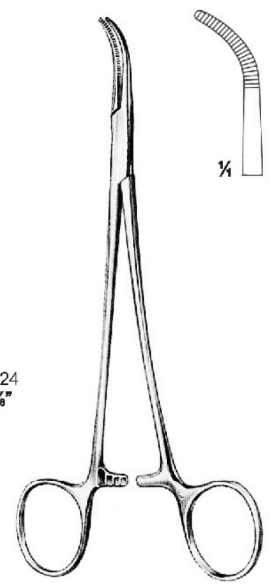

MIXTER-BABY
 OI 11-2631-14
 14 cm/5 1/2"



KELLY



Fig. 1
 OI 11-2632-19
 19 cm/7 1/2"



Fig. 1
 OI 11-2632-22
 22.5 cm/8 3/4"



Fig. 1
 OI 11-2632-24
 24.5 cm/9 5/8"



Fig. 2
 OI 11-2633-19
 19 cm/7 1/2"



Fig. 2
 OI 11-2633-22
 22 cm/8 1/2"



Fig. 2
 OI 11-2633-23
 23.5 cm/9 1/4"



Fig. 3
 OI 11-2634-18
 18.5 cm/7 1/4"



Fig. 3
 OI 11-2634-21
 21.5 cm/8 1/2"

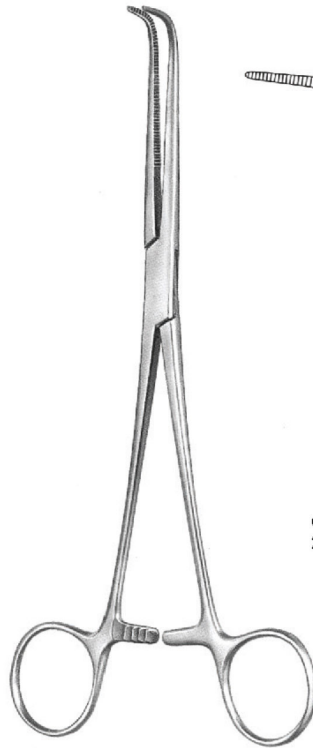

Fig. 3
 OI 11-2634-23
 23.5 cm/9 1/4"





LAWRENCE
OI 11-2635-28
28 cm/11"



WIKSTROEM



OI 11-2636-21
21 cm/8 1/4"



OI 11-2636-24
24.5 cm/9 1/2"



MEEKER
OI 11-2637-28
28 cm/11"

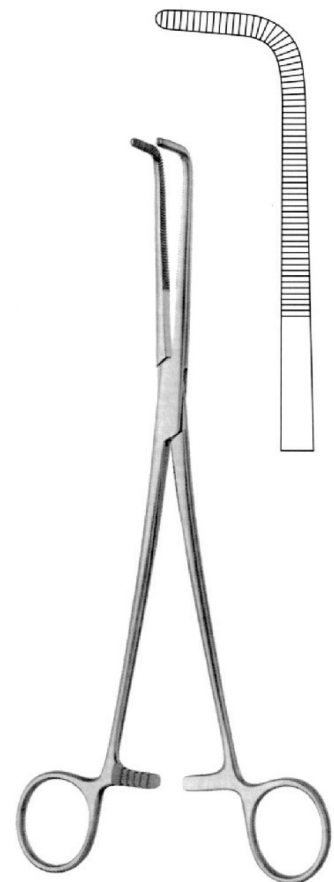

MIXTER-CRAFOORD
OI 11-2638-25 25 cm/9 1/2"
OI 11-2638-27 27 cm/10 1/2"



MINI-GEMINI

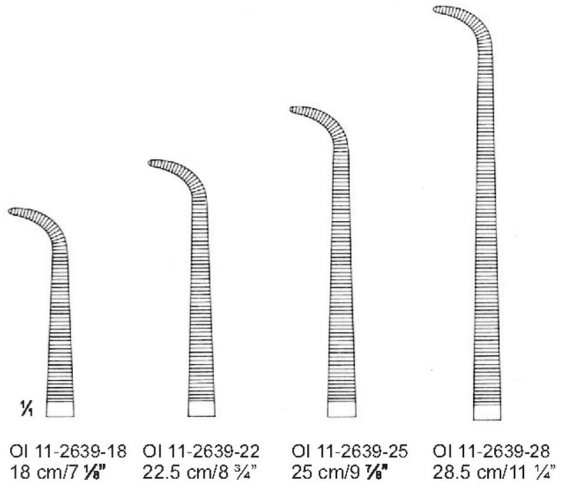

GEMINI

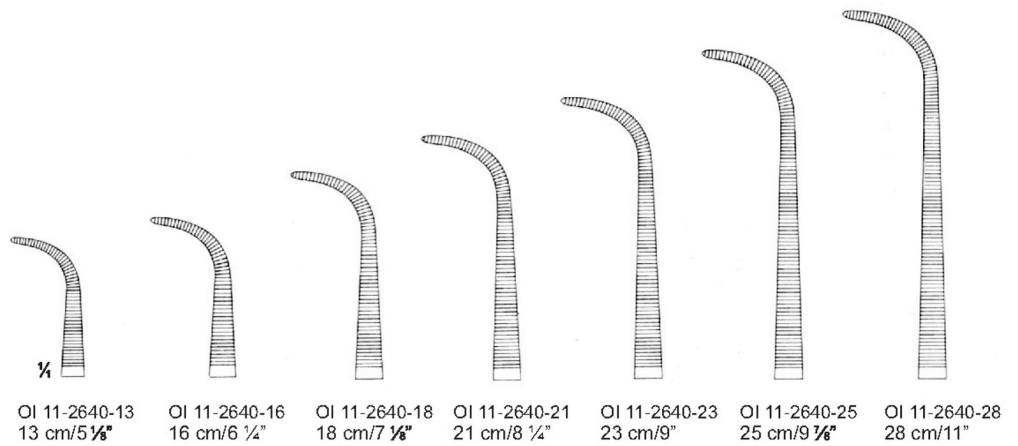

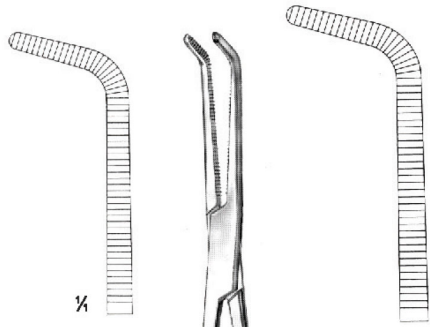

¼

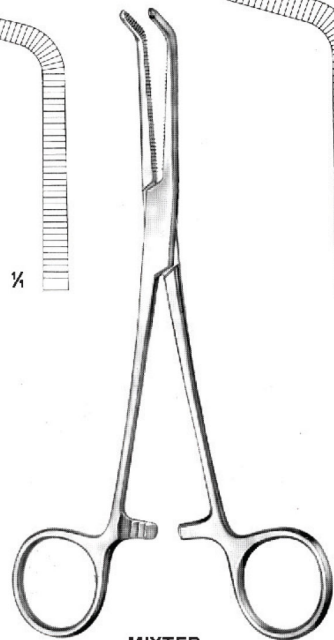

MIXTER

- OI 11-2641-14 14.5 cm/5 ¾"
- OI 11-2641-15 15.5 cm/6 1/8"
- OI 11-2641-19 19 cm/7 ½"

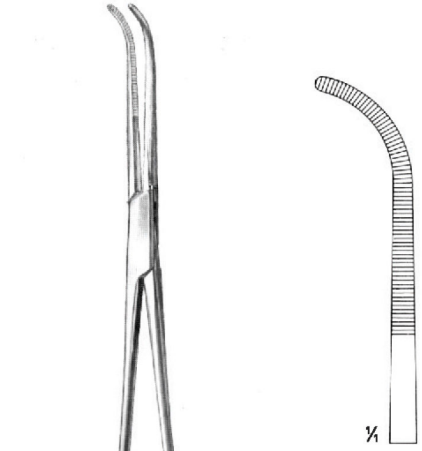

¼



MIXTER

- OI 11-2642-22
22 cm/8 ½"



¼

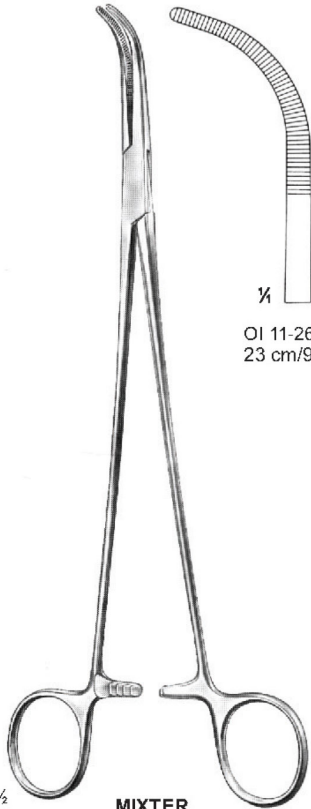

MIXTER

- OI 11-2643-23
23 cm/9"

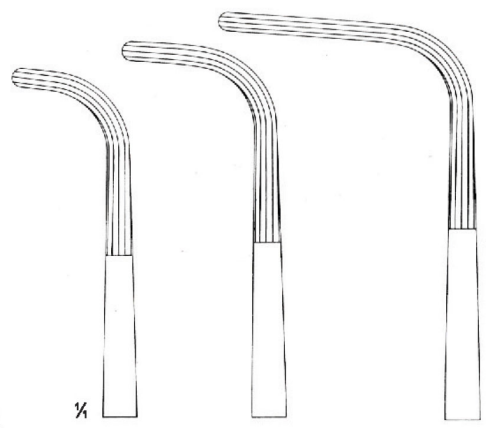

¼

Fig. 1

- OI 11-2644-22
22 cm/8 ½"

2

- OI 11-2644-25
25 cm/9 7/8"

3

- OI 11-2644-28
28 cm/11"

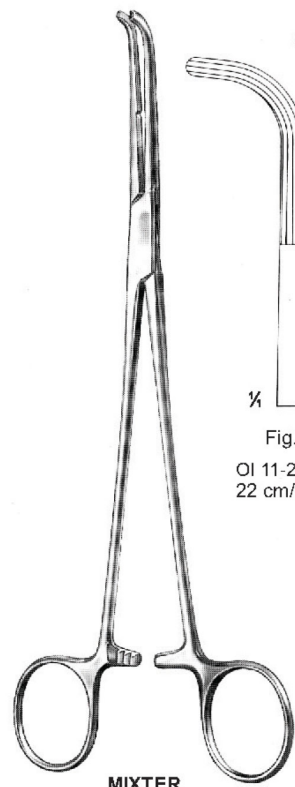

MIXTER



O'SHAUGNESSY

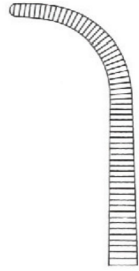

OI 11-2645-15
15 cm/5 7/8"

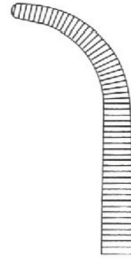

OI 11-2645-18
18 cm/7 1/8"

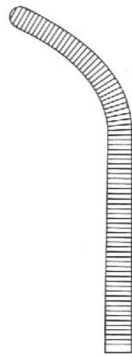

OI 11-2645-19
18.5 cm/7 1/4"



OI 11-2645-20
20 cm/7 7/8"

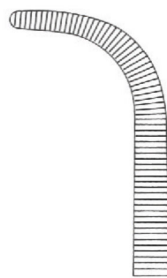

OI 11-2645-23
23 cm/9"



OI 11-2645-26
26 cm/10 1/4"



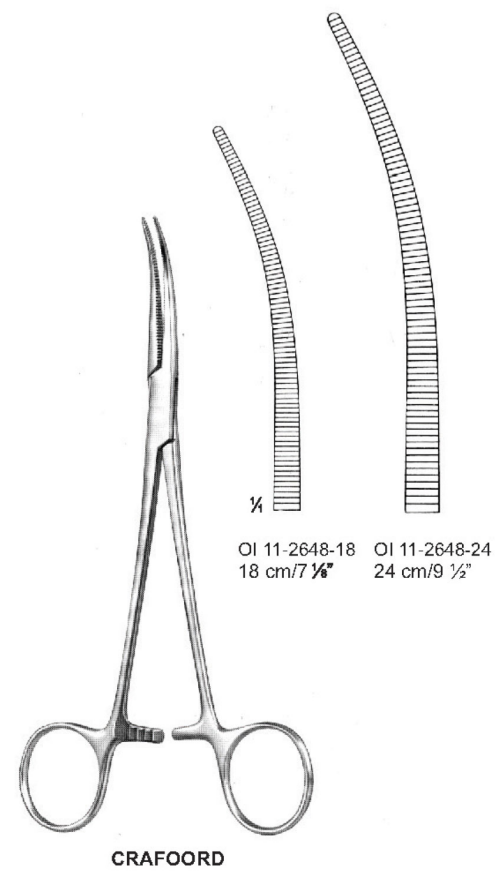
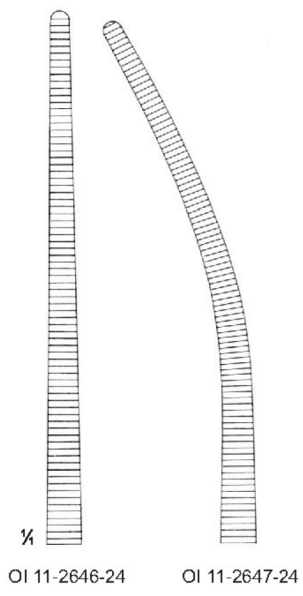
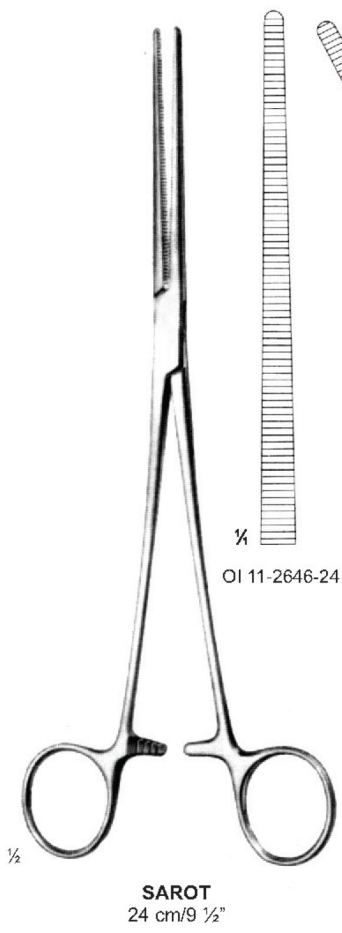

ARTERY FORCEPS

Dissecting and Ligature Forceps ● EN
 Präparierklemmen ● DE
 Pinzas para preparación y ligadura ● ES



CRAFOORD-SELLORS
 24 cm/9 1/2"
 Vascular Clamp

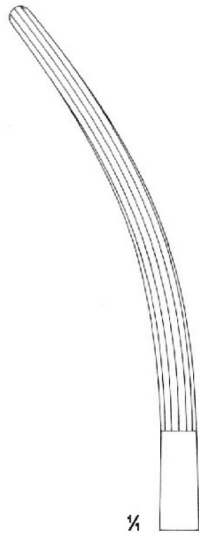

1/4
 OI 11-2649-24

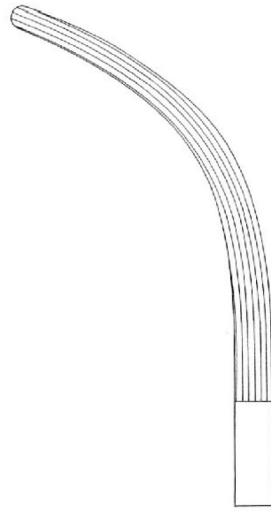

OI 11-2650-24

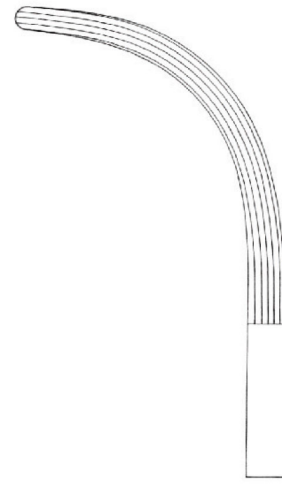

OI 11-2651-24



JOHNS HOPKINS
 OI 11-2652-20
 20 cm/7 7/8"

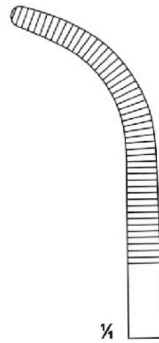

1/4

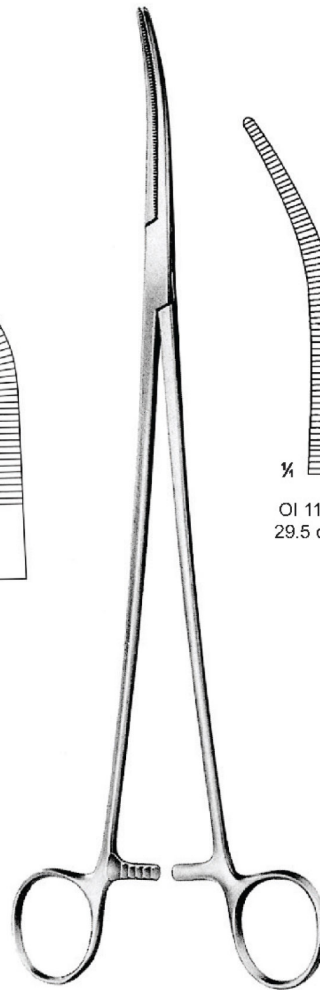

ZENKER



1/4
 OI 11-2653-29
 29.5 cm/11 5/8"

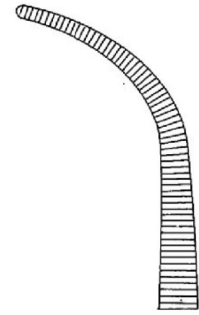

OI 11-2653-28
 28.5 cm/11 1/4"



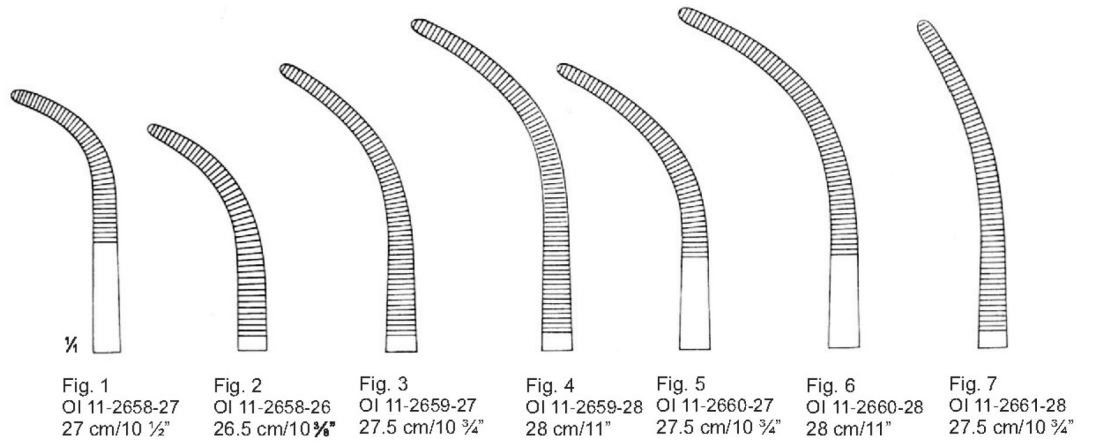
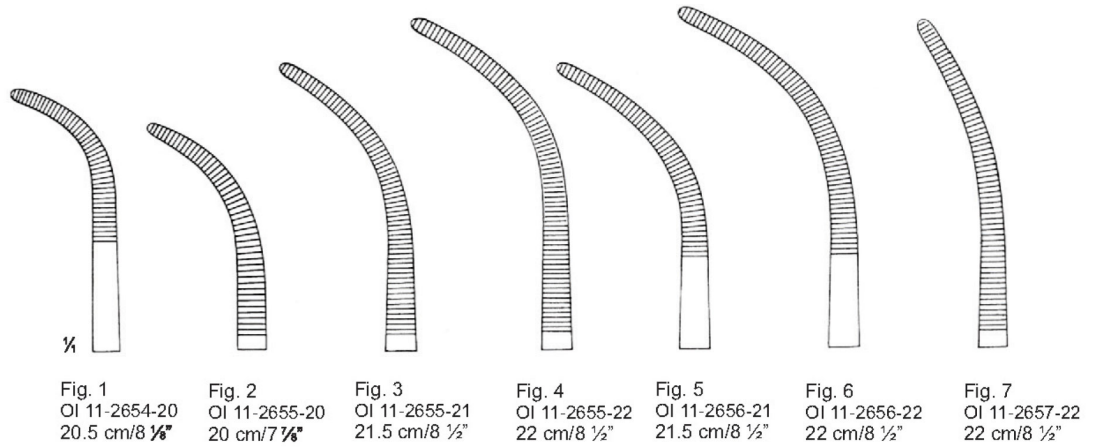

OVERHOLT-GEISSENDORFER

ARTERY FORCEPS

Dissecting and Ligature Forceps — EN
 Präparierklemmen — DE
 Pinzas para preparación y ligadura — ES



OVERHOLT-FINO

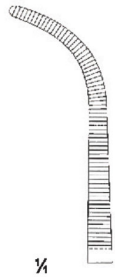

¼

OI 11-2662-21
21.5 cm/8 ½"

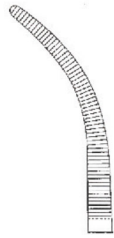

OI 11-2662-22
22 cm/8 ½"

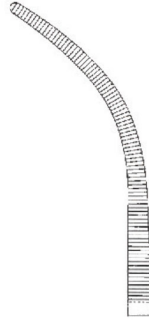

OI 11-2663-22
22.5 cm/8 ¾"

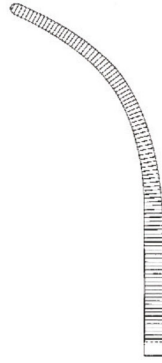

OI 11-2663-23
23 cm/9"

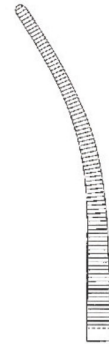

OI 11-2664-22
22.5 cm/8 ¾"



OVERHOLT-SLIM



¼

Fig. 1
OI 11-2665-18
18.5 cm/7 ¼"

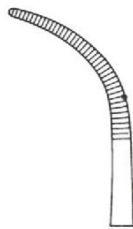

Fig. 2
OI 11-2665-20
20.5 cm/8 ⅛"

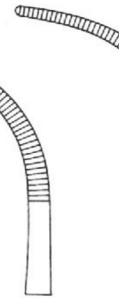

Fig. 3
OI 11-2665-21
21 cm/8 ¼"

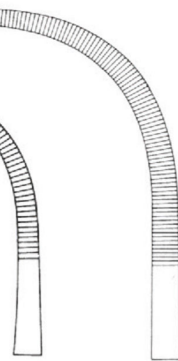
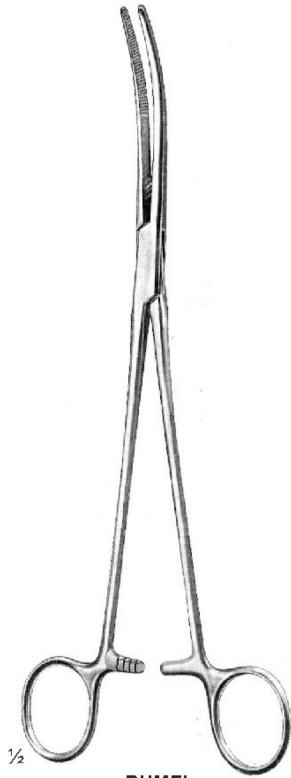

Fig. 4
OI 11-2666-21
21.5 cm/8 ½"

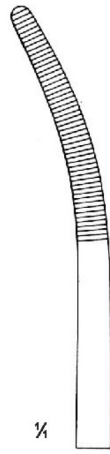

Fig. 5
OI 11-2666-24
24.5 cm/9 ⅝"





RUMEL
23 cm/9"



OI 11-2667-23

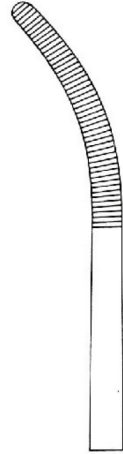

OI 11-2668-23

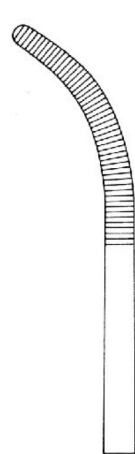

OI 11-2669-23

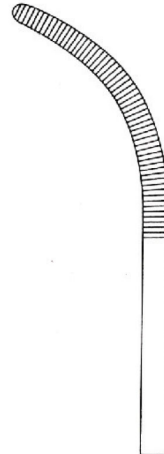

OI 11-2670-23

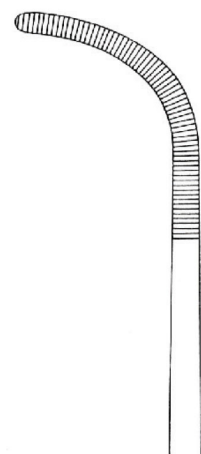

OI 11-2671-23

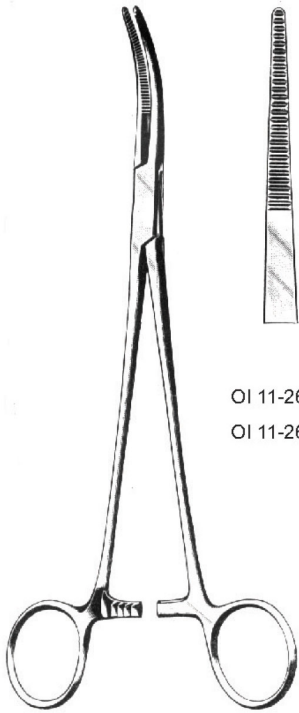

OI 11-2672-21
 OI 11-2672-26



TOENNIS



OI 11-2673-21 21.0 cm 8 1/4"
 OI 11-2673-26 26.0 cm 10 1/4"



OI 11-2674-21
 OI 11-2674-26



TOENNIS

1:2

OI 11-2675-21
 OI 11-2675-26

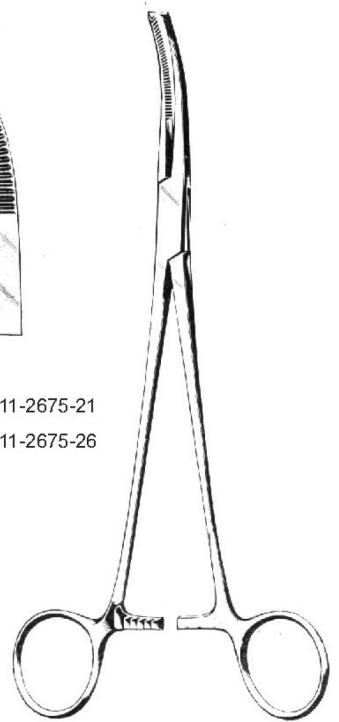

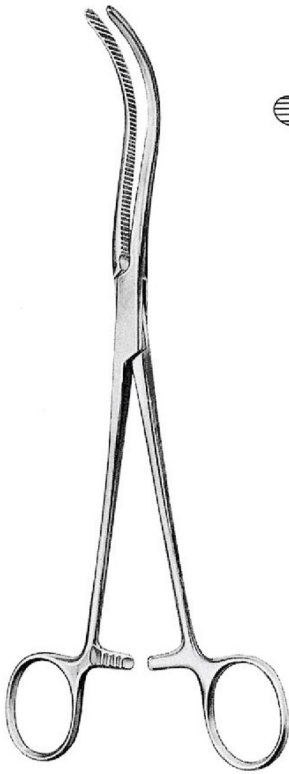

GUYON

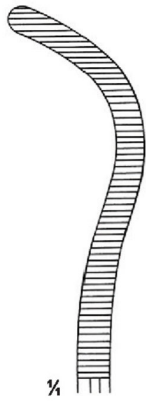

1/4
 OI 11-2676-20
 20 cm/7 7/8"

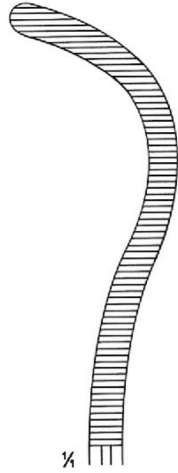

1/4
 OI 11-2676-22
 22 cm/8 1/2"

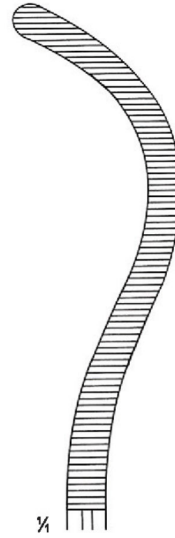

1/4
 OI 11-2676-24
 24 cm/9 1/2"



GUYON
 OI 11-2677-23
 23 cm/9"

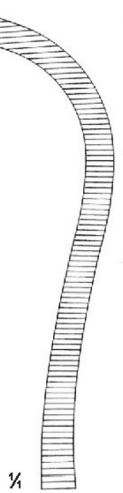

1/4

ATRAUMA



GUYON
 ATRAUMA

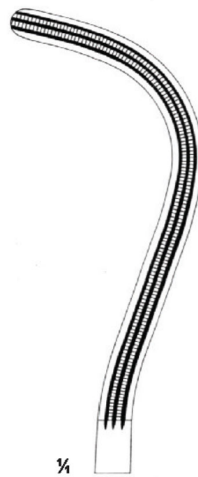

1/4
 OI 11-2678-23
 23 cm/9"

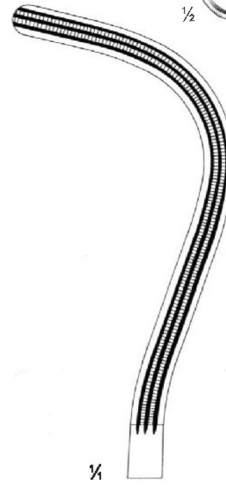

1/4
 OI 11-2678-24
 24 cm/9 1/2"



- EN** — Hysterectomy Forceps, Kidney Pedicle Clamps
- DE** — Hysterektomieklemmen, Nierenstielklemmen
- ES** — Pinzas para histerectomia, Pinzas para pedículo renal

ARTERY FORCEPS

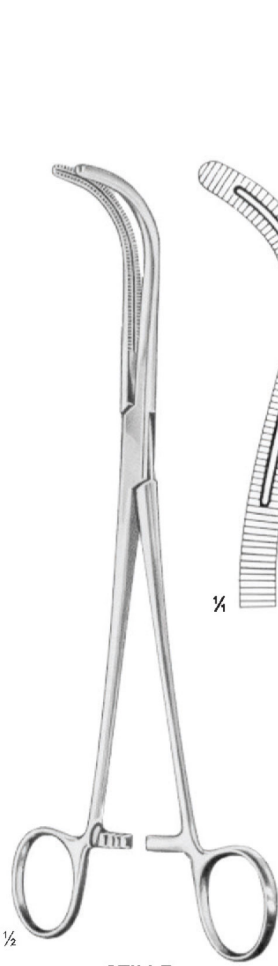

STILLE
OI 11-2679-23
23 cm/9"

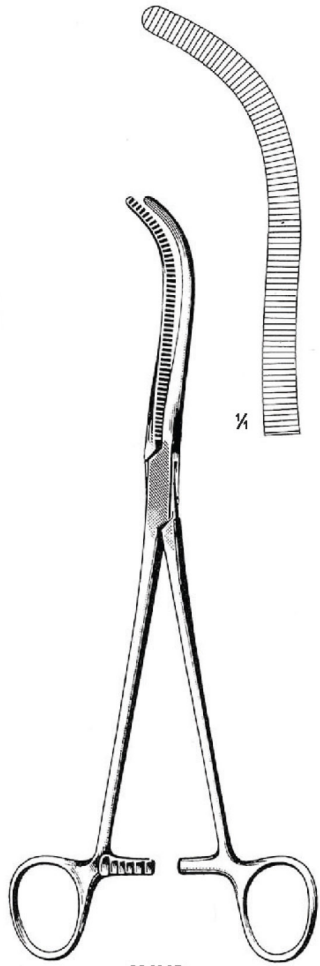

MAYO
OI 11-2680-23
23 cm/9"

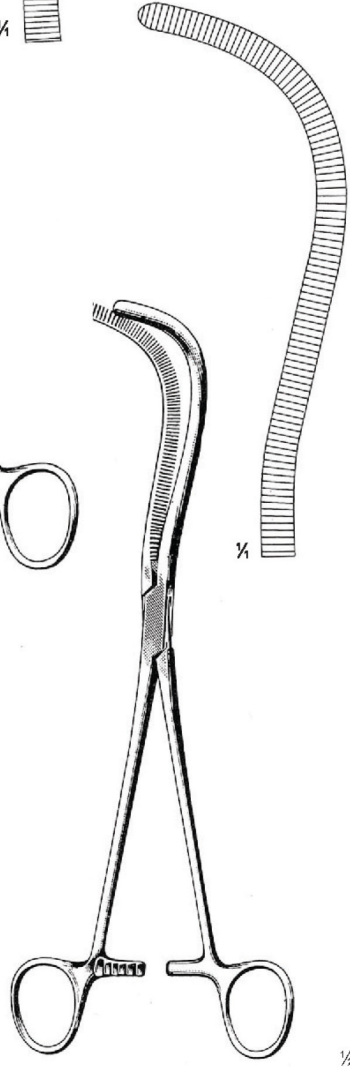

MAYO-GUYON
OI 11-2681-23
23 cm/9"

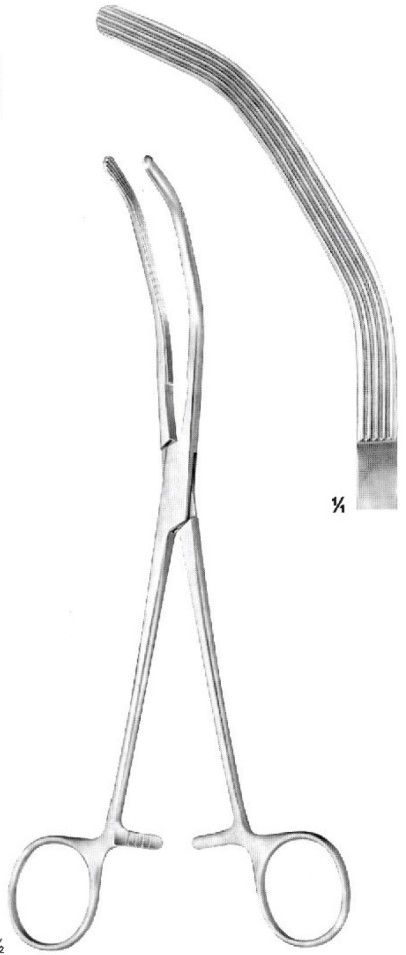

HERRICK
OI 11-2682-23
23 cm/9"

ARTERY FORCEPS

Hysterectomy Forceps, Kidney Pedicle Clamps
 Hysterektomieklemmen, Nierenstielklemmen
 Pinzas para histerectomia, Pinzas para pedículo renal

- EN
- DE
- ES



STILLE
 OI 11-2683-22
 22 cm/8 1/2"

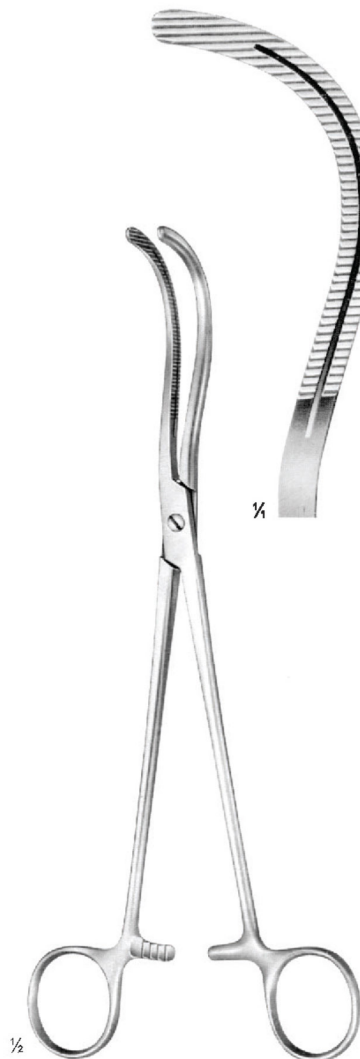

STILLE
 OI 11-2684-24
 24 cm/9 1/2"
 Screw Joint

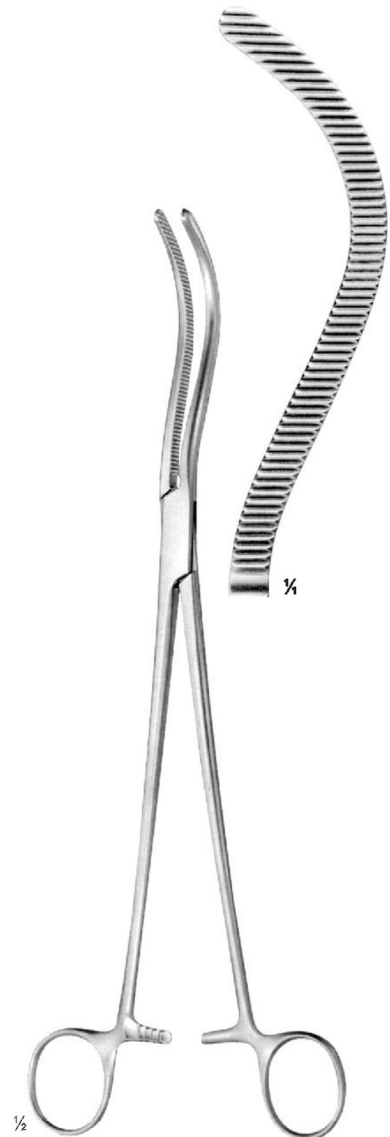

GUYON
 OI 11-2685-26
 26.5 cm/10 3/8"



- EN —●— Gall Duct Clamps
- DE —●— Gallenkanalklemmen
- ES —●— Pinzas para conducto biliar

ARTERY FORCEPS



GRAY

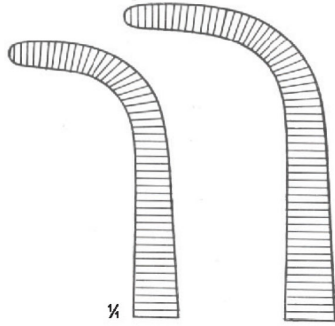
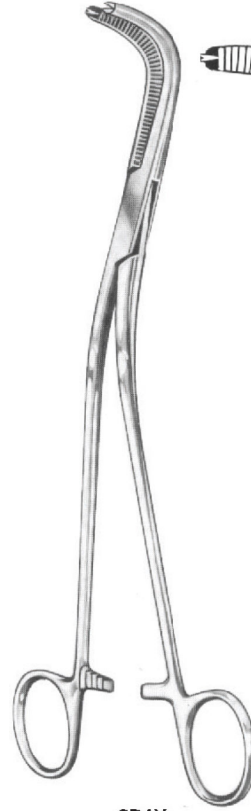

Fig. 1
OI 11-2687-22
22 cm/8 1/2"

2
OI 11-2687-23
23 cm/9"



GRAY
1:2

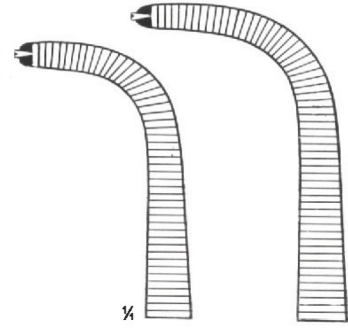
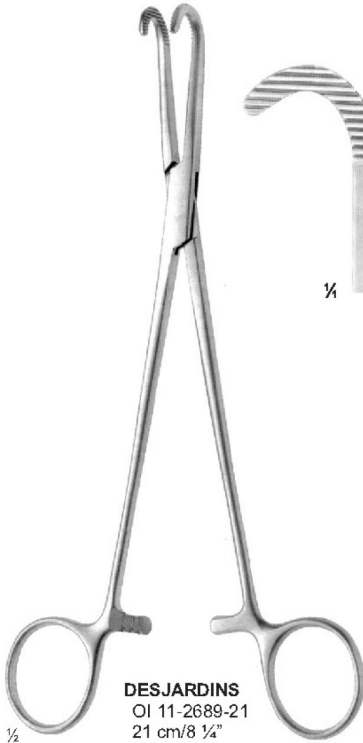

Fig. 1
OI 11-2688-22
22 cm/8 1/2"

2
OI 11-2688-23
23 cm/9"



DESJARDINS
OI 11-2689-21
21 cm/8 1/4"



1/4

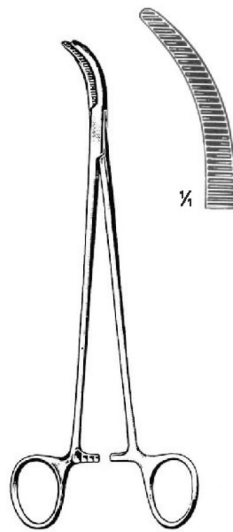

DESJARDINS
OI 11-2690-21
21 cm/8 1/4"



1/4

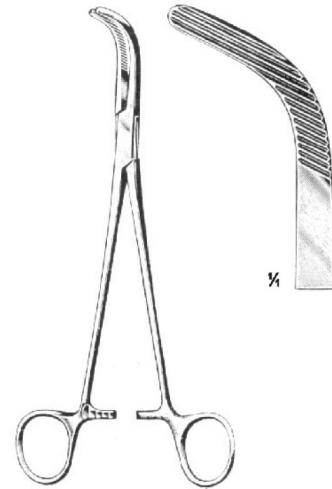

CRILE
OI 11-2691-20
20 cm/7 1/2"



1/4



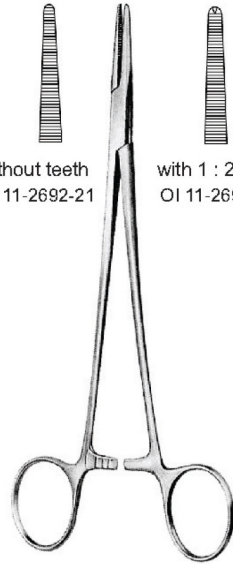
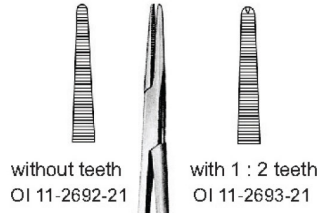

HOSEMANN
 21 cm / 8 1/4"

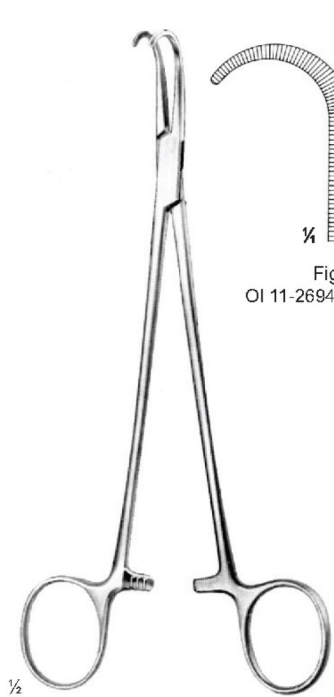

NEGUS
 19 cm / 7 1/2"

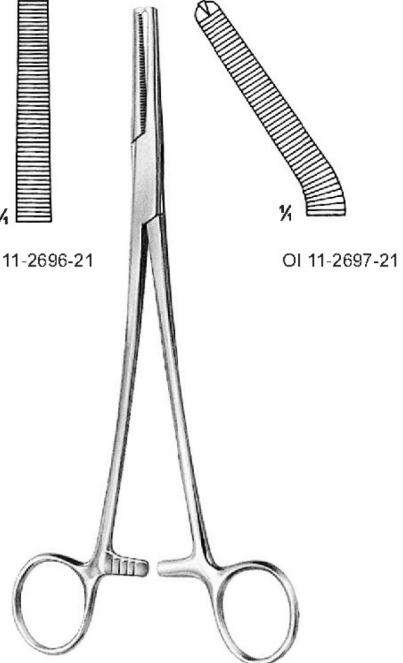
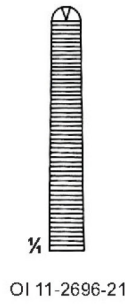
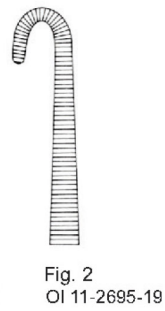
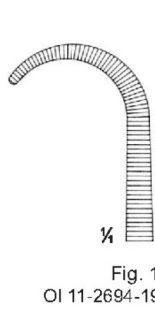

PHANEUF
 21.5 cm / 8 1/2"
 1 : 2

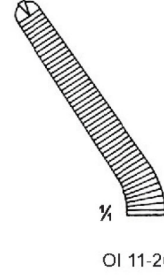

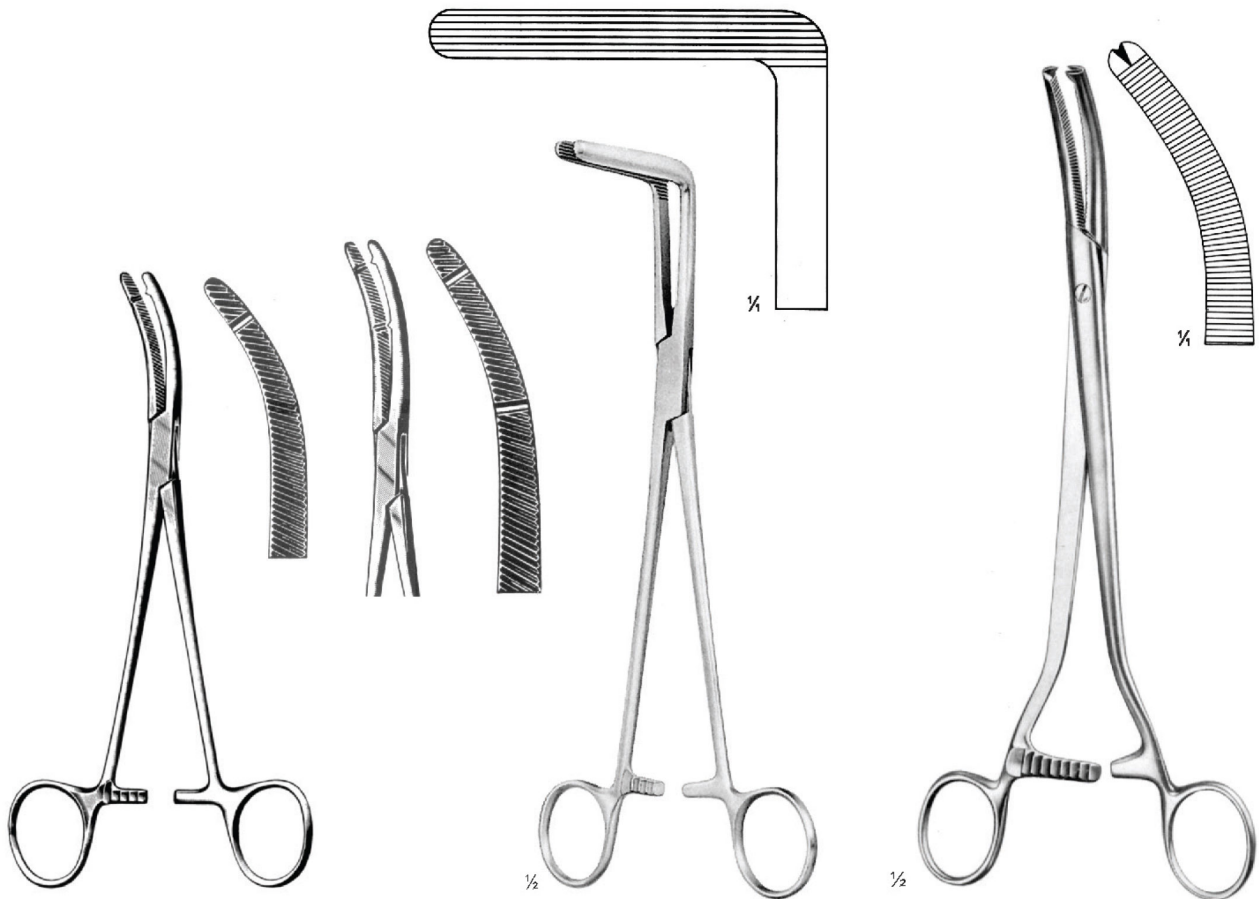

1 Tooth	HEANEY	2 Teeth
OI 11-2698-19	19.5 cm/7 1/2"	OI 11-2699-19
OI 11-2698-21	21.0 cm/8 1/4"	OI 11-2699-21
OI 11-2698-23	23.0 cm/9"	OI 11-2699-23

WERTHEIM-CULLEN
 OI 11-2700-21
 21.5 cm/8 1/2"

WERTHEIM
 OI 11-2701-24
 24 cm/9 1/2"
 Extra Strong





ROGERS

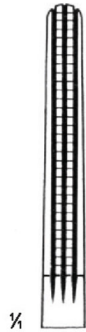

Fig. 1
 OI 11-2702-21
 21.5 cm/8 1/2"



Fig. 2
 OI 11-2703-21
 21 cm/8 1/4"



Fig. 3
 OI 11-2704-20
 20.5 cm/8 1/8"

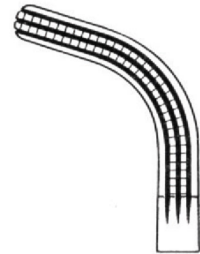

Fig. 4
 OI 11-2705-20
 20 cm/7 1/8"

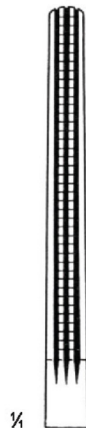

Fig. 1
 OI 11-2706-25
 25.5 cm/10"



Fig. 2
 OI 11-2707-25
 25 cm/9 1/4"

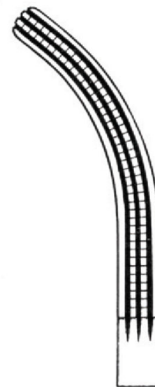
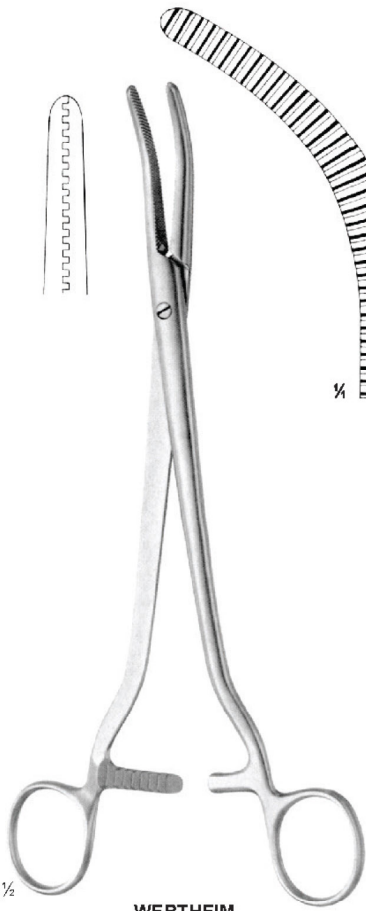
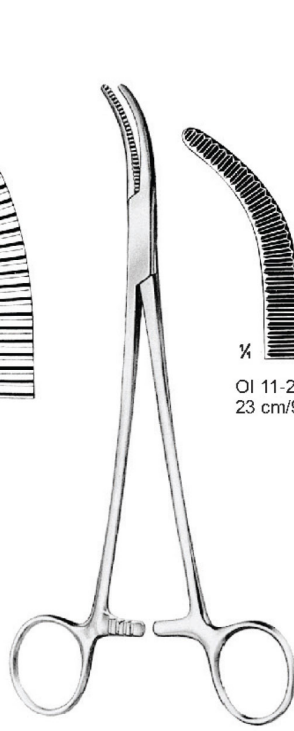

Fig. 3
 OI 11-2708-24
 24.5 cm/9 3/8"





WERTHEIM
OI 11-2709-25
25 cm/9 1/8"



MOYNIHAN



OI 11-2710-23
23 cm/9"



OI 11-2710-24
24 cm/9 1/2"

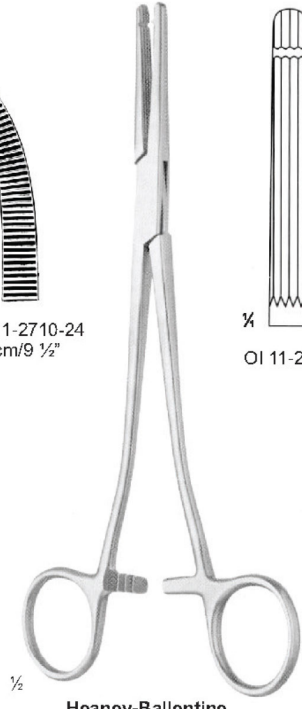

Heaney-Ballentine
21 cm/8 1/4"

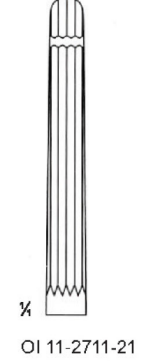

OI 11-2711-21

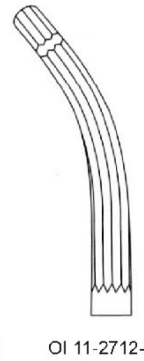

OI 11-2712-21

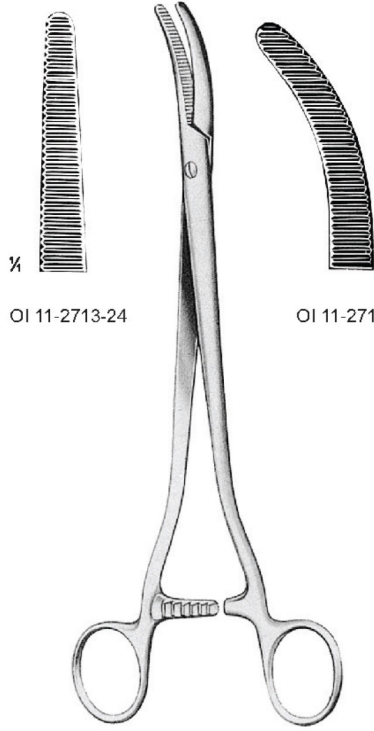

SEGOND-LANDAU
24 cm/9 1/2"



OI 11-2713-24



OI 11-2714-24

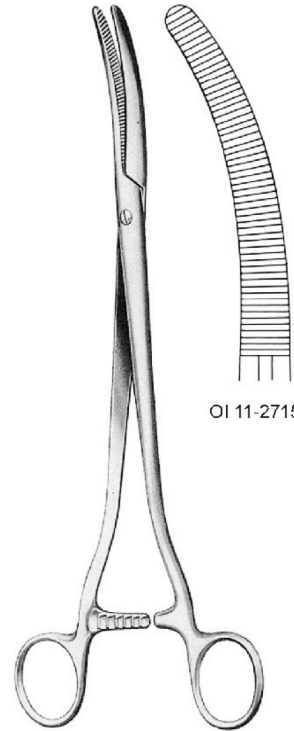

FAURE
25 cm/9 1/8"

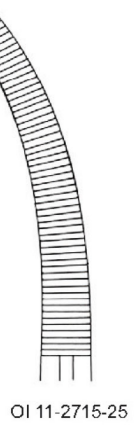

OI 11-2715-25

Heavy pattern



WERTHEIM
 23 cm/9"

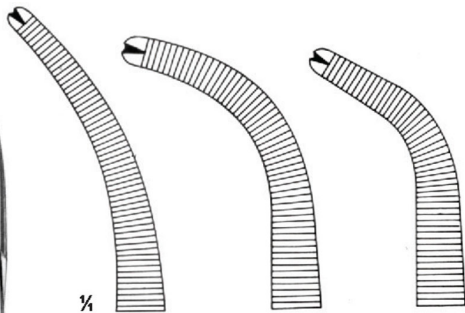

OI 11-2716-23 OI 11-2717-23 OI 11-2718-23

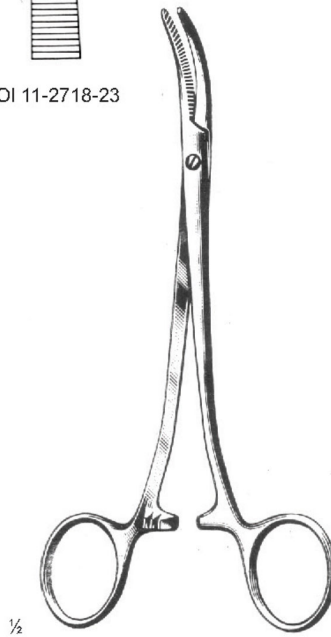

WERTHEIM
 OI 11-2719-18
 18 cm/7 1/8"

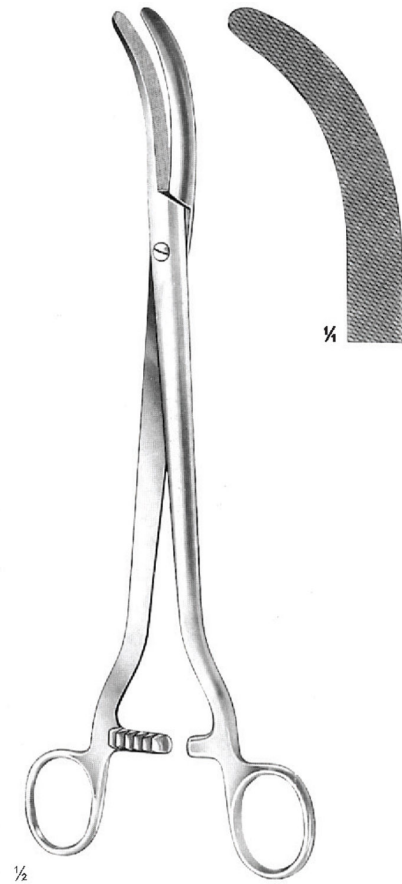

WERTHEIM
 OI 11-2720-25
 25 cm/9 7/8"



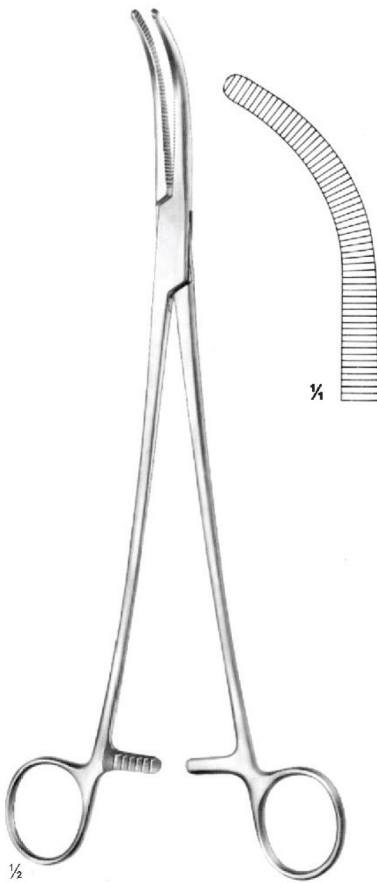

WERTHEIM
 OI 11-2721-25
 25 cm/9 7/8"

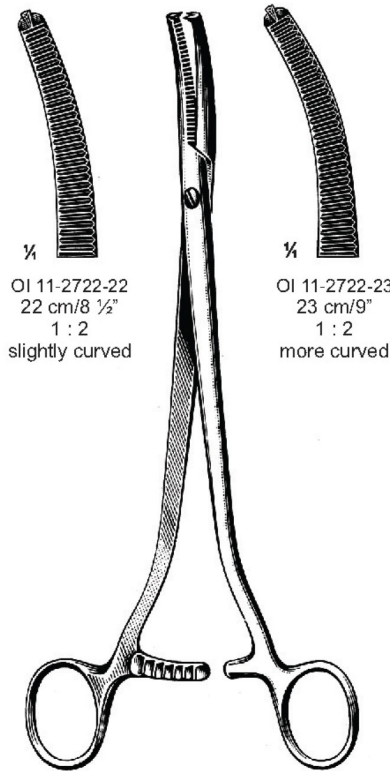

1/4
 OI 11-2722-22
 22 cm/8 1/2"
 1 : 2
 slightly curved

1/4
 OI 11-2722-23
 23 cm/9"
 1 : 2
 more curved

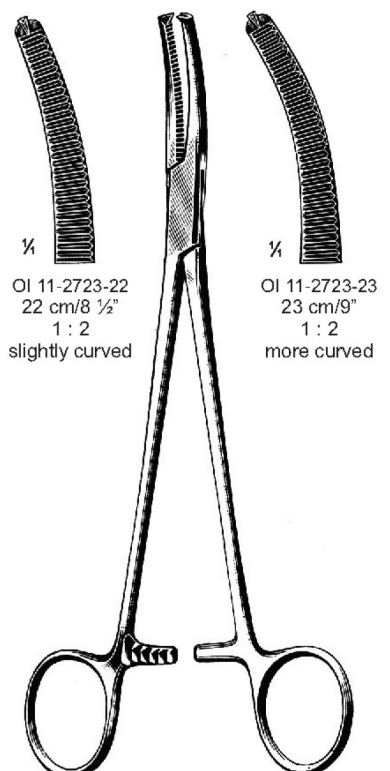

1/4
 OI 11-2723-22
 22 cm/8 1/2"
 1 : 2
 slightly curved

1/4
 OI 11-2723-23
 23 cm/9"
 1 : 2
 more curved

WERTHEIM

WERTHEIM

ARTERY FORCEPS

Hysterectomy Forceps ● EN
 Peritoneumklemmen ● DE
 Pinzas-clamps para peritoneo ● ES

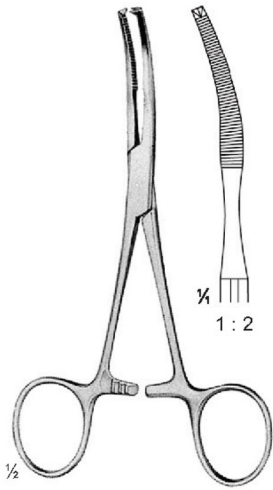

BABY-MIKULICZ
 OI 11-2724-14
 14 cm/5 1/2"

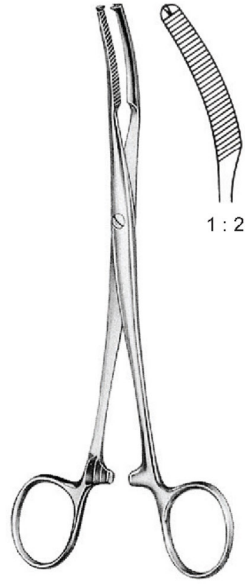

MIKULICZ
 OI 11-2725-18 18 cm/7 1/8"
 OI 11-2725-20 20 cm/7 7/8"

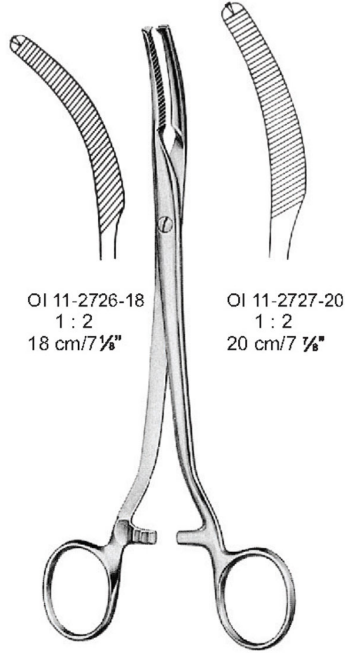

OI 11-2726-18
 1:2
 18 cm/7 1/8"

OI 11-2727-20
 1:2
 20 cm/7 7/8"

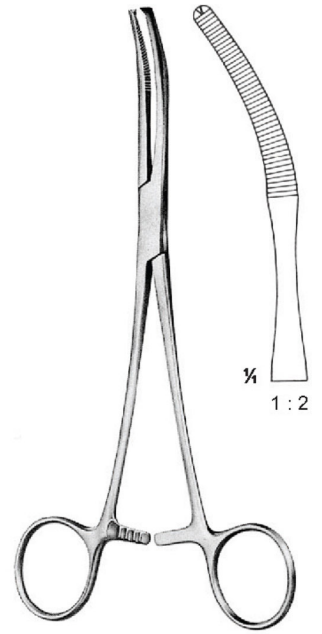

MIKULICZ
 OI 11-2728-20 20 cm/7 7/8"

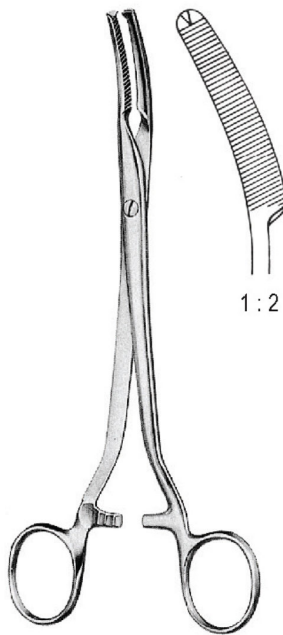

MIKULICZ
 OI 11-2729-20
 20.5 cm/8 1/8"

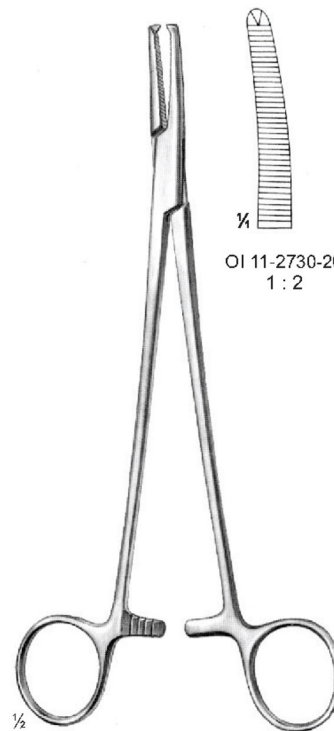

FAURE
 20 cm/7 7/8"

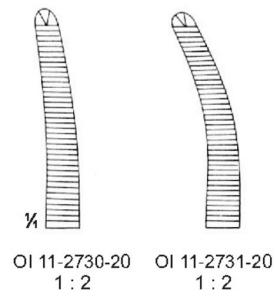

OI 11-2730-20
 1:2

OI 11-2731-20
 1:2





ARTERY FORCEPS

Towel Clamps — EN
 Tuchklemmen — DE
 Pinzas de campo — ES

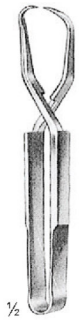

SCHAEDEL
 OI 11-2738-09 11 cm/4 3/8"
 9 cm/3 1/2"

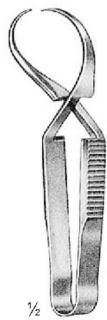

ENGL. MODELL
 OI 11-2739-09 9 cm/3 1/2"



JONES
 OI 11-2740-05 5 cm/2"
 OI 11-2740-09 9 cm/3 1/2"



JONES
 OI 11-2741-09 9 cm/3 1/2"



DOYEN
 OI 11-2742-11 11 cm/4 3/8"

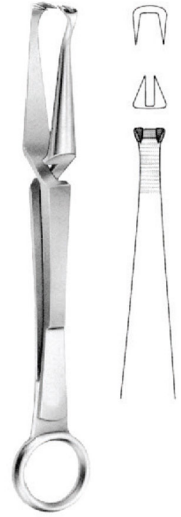

DOYEN
 OI 11-2743-18 18 cm/7 1/8"

With Clip for Tubing or Cable



BACKHAUS
 OI 11-2744-11 11 cm/4 3/8"
 OI 11-2744-13 13 cm/5 1/8"
 Delicate pattern, sharp



BACKHAUS
 OI 11-2745-11 11 cm/4 3/8"
 With Clip for Tubing or Cable

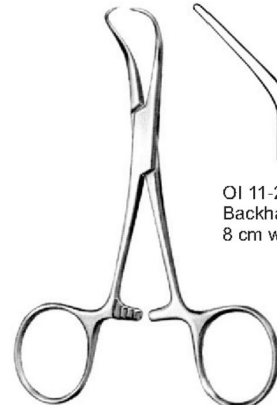

BACKHAUS
 OI 11-2746-08 8 cm/3 1/8"
 OI 11-2746-08 11 cm/4 3/8"
 OI 11-2746-08 13 cm/5 1/8"
 OI 11-2746-08 15 cm/5 7/8"

OI 11-2747-08
 Backhaus Towel
 8 cm with open jaws





BALL & SOCKET

OI 11-2748-11
11.5 cm/4 1/2"

OI 11-2748-14
14 cm/5 1/2"



TOHOKU

OI 11-2749-10
10.5 cm/4 1/8"

OI 11-2749-13
13.5 cm/5 3/8"

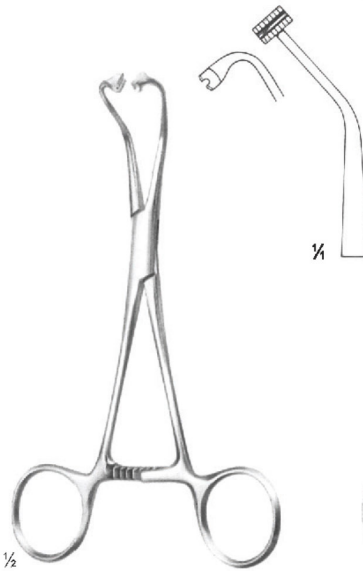

PEERS BERTRAM

OI 11-2750-14
14.5 cm/5 3/4"

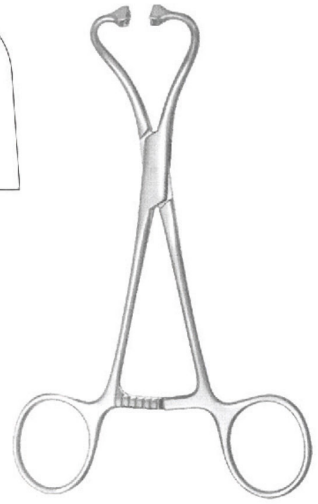
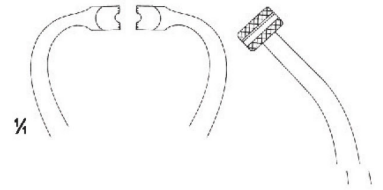

PEERS-BERTRAM MODIF.

OI 11-2751-15
15.5 cm/6 1/8"

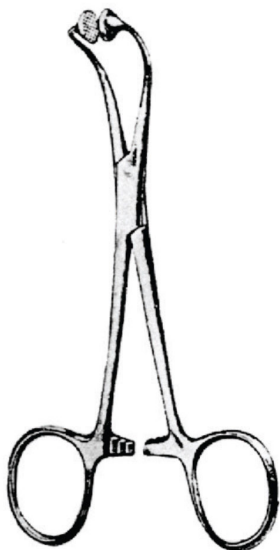

HOFF

OI 11-2752-11 11 cm/4 3/8"
OI 11-2752-14 14.5 cm/5 3/4"

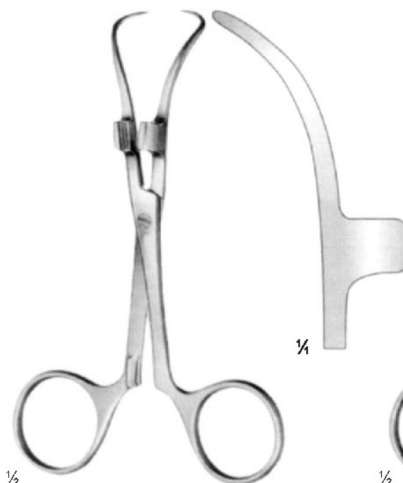

ROBIN

OI 11-2753-13 13.5 cm/5 3/8"
with holder for cable up to 5 mm

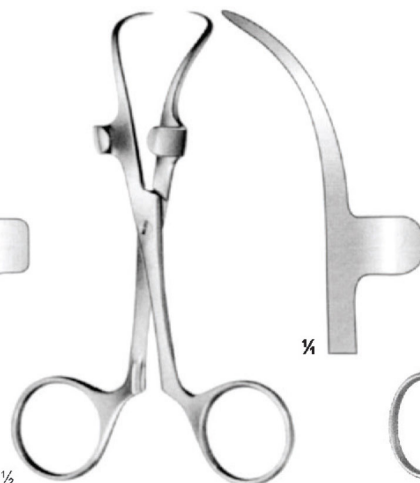

ROBIN

OI 11-2754-13 13.5 cm/5 3/8"
with holder for cable up to 13 mm tubing



PAPER TOWEL FORCEPS

OI 11-2755-10 10 cm/3 7/8"
OI 11-2755-13 13 cm/5 1/8"

ARTERY FORCEPS

Towel Forceps, Tubing Clamps — EN
 Tuchklemmen, Schlauchklemmen — DE
 Pinzas de campo, Pinzas para tubos — ES



ROEDER
 OI 11-2756-13 13 cm/5 1/8"
 OI 11-2756-15 15 cm/5 7/8"



LORNA
 OI 11-2757-10 10 cm/3 7/8"
 OI 11-2757-13 13 cm/5 1/8"

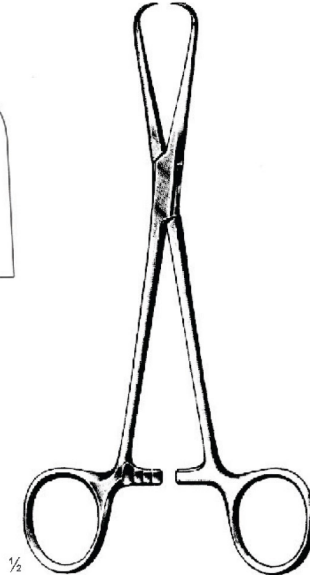

BERNHARD
 OI 11-2758-16
 16.5 cm/6 1/2"



LANE
 OI 11-2759-20
 20 cm/7 7/8"

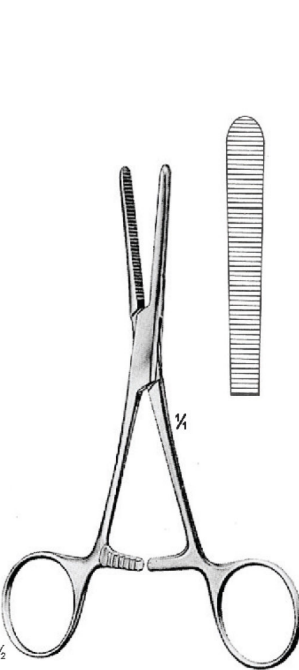

OI 11-2760-14
 14.5 cm/5 3/4"
 with extra long ratchet

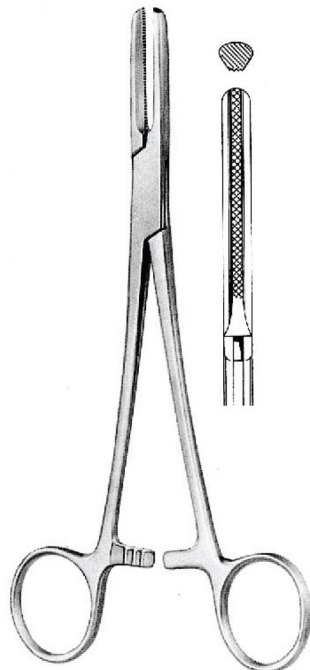

SCHOENBERG
 OI 11-2761-15 15.5 cm/6 1/8"
 OI 11-2761-19 19 cm/7 1/2"
 OI 11-2761-20 20 cm/7 7/8"



SCHOENBERG
 OI 11-2762-15 15.5 cm/6 1/8"
 OI 11-2762-19 19 cm/7 1/2"
 OI 11-2762-20 20 cm/7 7/8"
 with safety guard

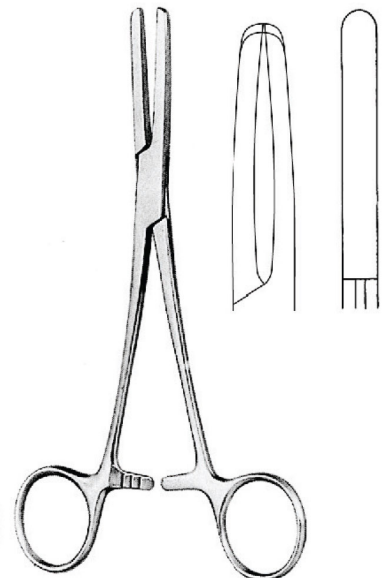

PRESBYTERIAN-HOSPITAL
 OI 11-2763-15 15.5 cm/6 1/8"
 OI 11-2763-19 19 cm/7 1/2"
 OI 11-2763-20 20 cm/7 7/8"



- EN** —● Sinus Forceps, Dressing Forceps
- DE** —● Sinusklemmen, Kornzangen
- ES** —● Pinzas para vendajes, Pinzas para vendajes

ARTERY FORCEPS



LISTER
OI 11-2764-20
20 cm/7 7/8"

1/4

OI 11-2764-13
13 cm/5 1/8"



OI 11-2764-15
15 cm/5 7/8"



OI 11-2764-18
18 cm/7 1/8"

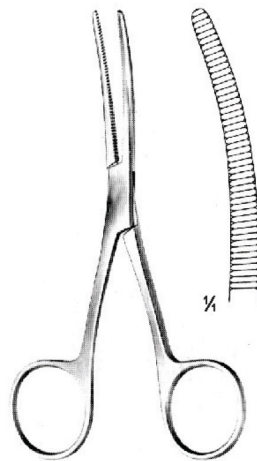

BRYANT
OI 11-2765-13
13 cm/5 1/8"

