

- EN** Cardiovascular Surgery
- DE** Herz- und Gefäßchirurgie
- ES** Cirugía cardiovascular

Page 388 to 498

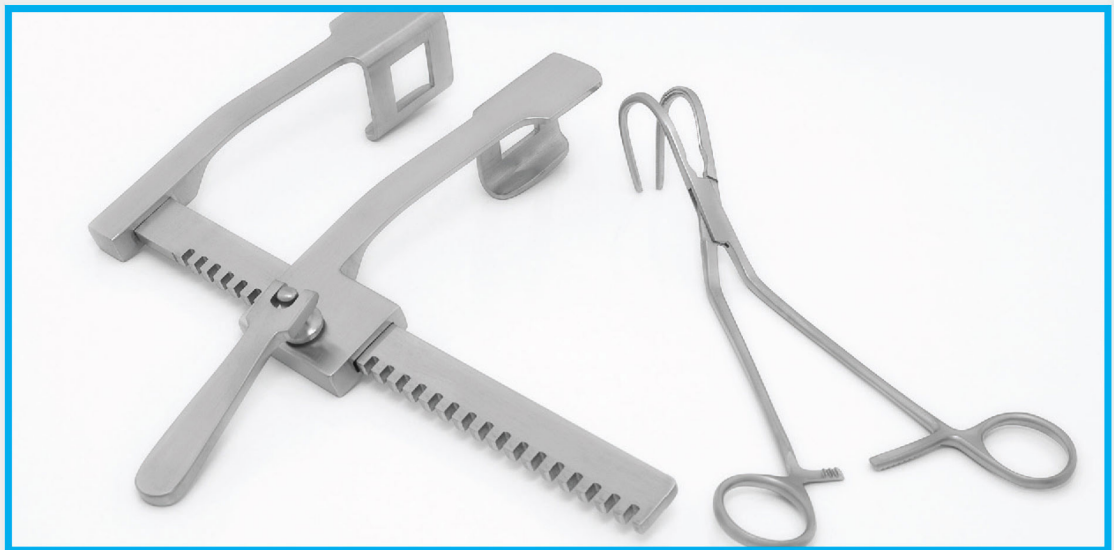



1.5 mm

OI 19-5501-12 12.5cm
 OI 19-5501-15 15cm

DEBAKEY-ADSON



1.0 mm

OI 19-5502-15 15.0cm
 OI 19-5502-18 18.0cm



1.2 mm

OI 19-5503-15 15.0cm
 OI 19-5503-18 18.0cm
 OI 19-5503-24 24.0cm

DEBAKEY-GERALD



1.0mm

OI 19-5504-18
 18.0cm

DEBAKEY-CUSHING



1.0mm

OI 19-5505-15 15.0cm
 OI 19-5505-19 19.0cm
 OI 19-5505-24 24.0cm

DEBAKEY-DIETRICH



1.5mm

OI 19-5506-15
 OI 19-5506-19
 OI 19-5506-24



1.0mm

OI 19-5507-15 15.0cm
 OI 19-5507-19 19.0cm
 OI 19-5507-24 24.0cm

DEBAKEY-LIGHT

Also available in titanium

1.5 mm

DE BAKEY
 OI 19-5508-16 16.0cm
 OI 19-5508-20 20.0cm
 OI 19-5508-24 24.0cm
 OI 19-5508-30 30.0cm

2.0 mm

DE BAKEY
 OI 19-5509-16 16.0cm
 OI 19-5509-20 20.0cm
 OI 19-5509-24 24.0cm
 OI 19-5509-30 30.0cm

2.7 mm

DE BAKEY
 OI 19-5510-16 16.0cm
 OI 19-5510-20 20.0cm
 OI 19-5510-24 24.0cm
 OI 19-5510-30 30.0cm

3.5mm

DE BAKEY
 OI 19-5511-16 16.0cm
 OI 19-5511-20 20.0cm
 OI 19-5511-24 24.0cm
 OI 19-5511-30 30.0cm

2mm

DE BAKEY
 OI 19-5512-16 16.0cm
 OI 19-5512-20 20.0cm
 OI 19-5512-24 24.0cm
 OI 19-5512-30 30.0cm

2.7mm

DE BAKEY
 OI 19-5513-16 16.0cm
 OI 19-5513-20 20.0cm
 OI 19-5513-24 24.0cm
 OI 19-5513-30 30.0cm



Also available in titanium

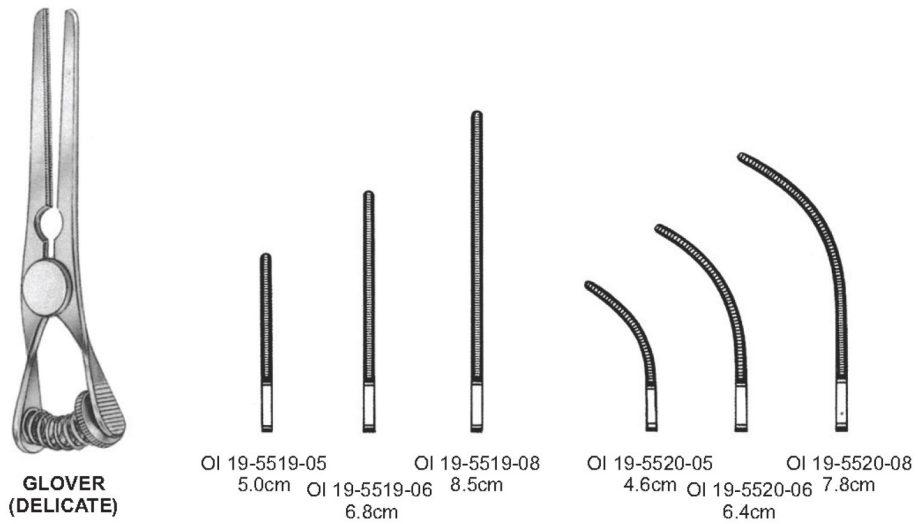
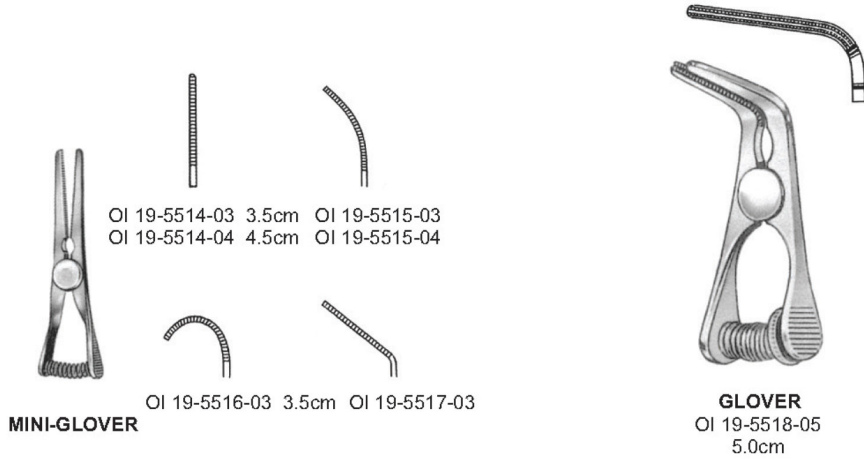

Also available in titanium

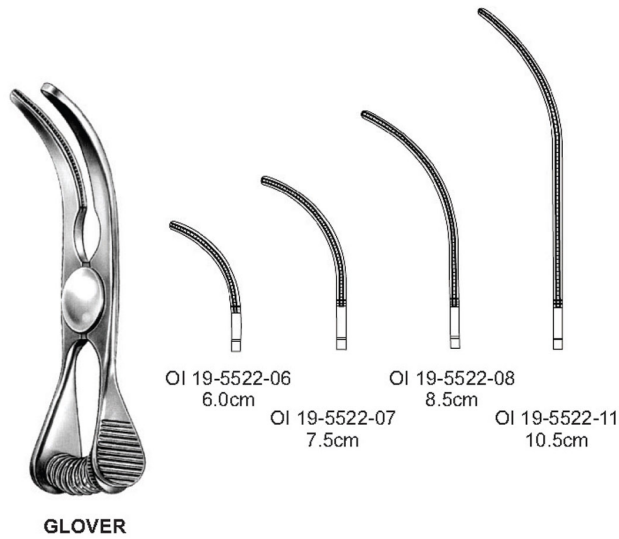
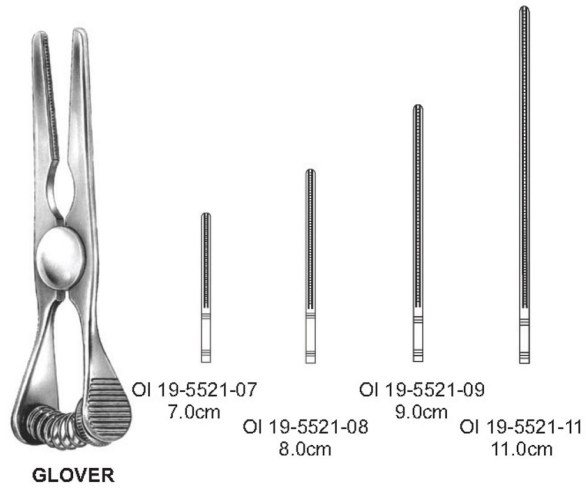

- EN —●— Atrauma Bulldog Clamps
- DE —●— Atrauma Bulldogklemmen
- ES —●— Atrauma Clamps Bulldog

Also available in titanium



DE BAKEY



OI 19-5529-07
7.5cm



OI 19-5529-08
8.5cm



OI 19-5529-10
10.5cm



OI 19-5529-12
12.0cm



Also available in titanium

DE BAKEY



DE BAKEY



OI 19-5530-07
7.0cm



OI 19-5530-08
8.0cm



OI 19-5530-10
10.0cm

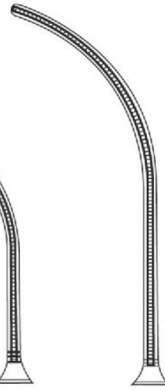

OI 19-5530-11
11.5cm



OI 19-5531-23
23.0cm



- EN —●— Atrauma Bulldog Clamps
- DE —●— Atrauma Bulldogklemmen
- ES —●— Atrauma Clamps Bulldog

Also available in titanium

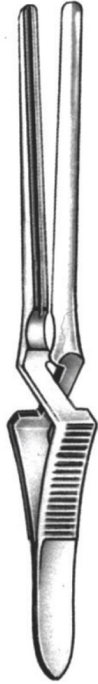

GREGORY SOFT

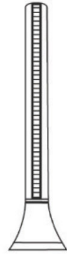

OI 19-5532-09
9.0cm

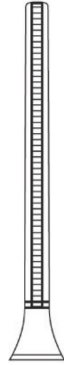

OI 19-5532-11
11.0cm



GREGORY SOFT

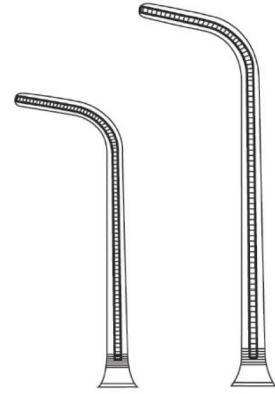

OI 19-5533-09 OI 19-5533-11
9.0cm 11.0cm



GREGORY SOFT
11.0cm



OI 19-5534-01 OI 19-5534-02

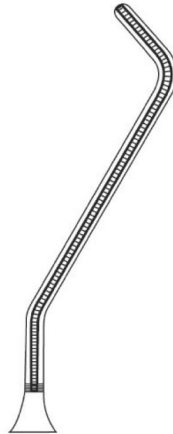

SANTULLI
OI 19-5535-07
7.0cm



Also available in titanium



DE BAKEY-SATINSKY
OI 19-5536-07
7.0cm

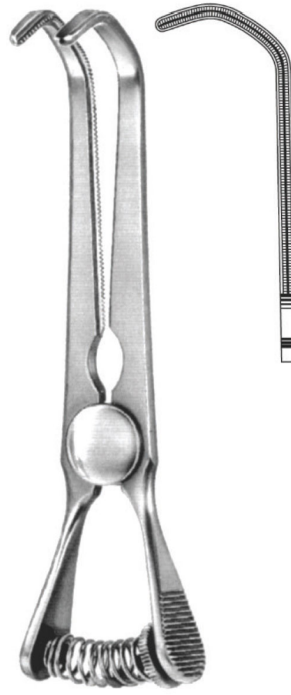

DE BAKEY-SATINSKY
OI 19-5537-10
10.0cm

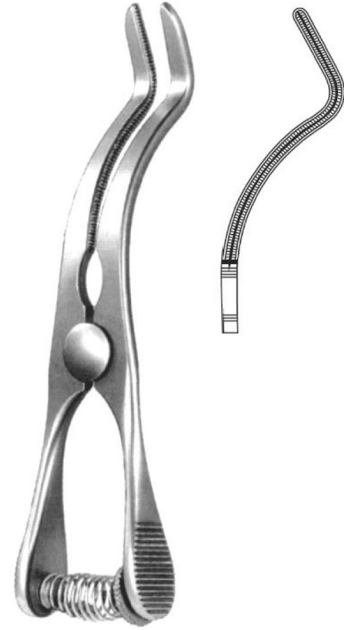

DE BAKEY-CAROTIS
OI 19-5538-09
9.0cm



- EN —●— Atrauma Cardiovascular Forceps
- DE —●— Atrauma cardiovascular-klemmen
- ES —●— Atrauma cardiovasculaire Forceps

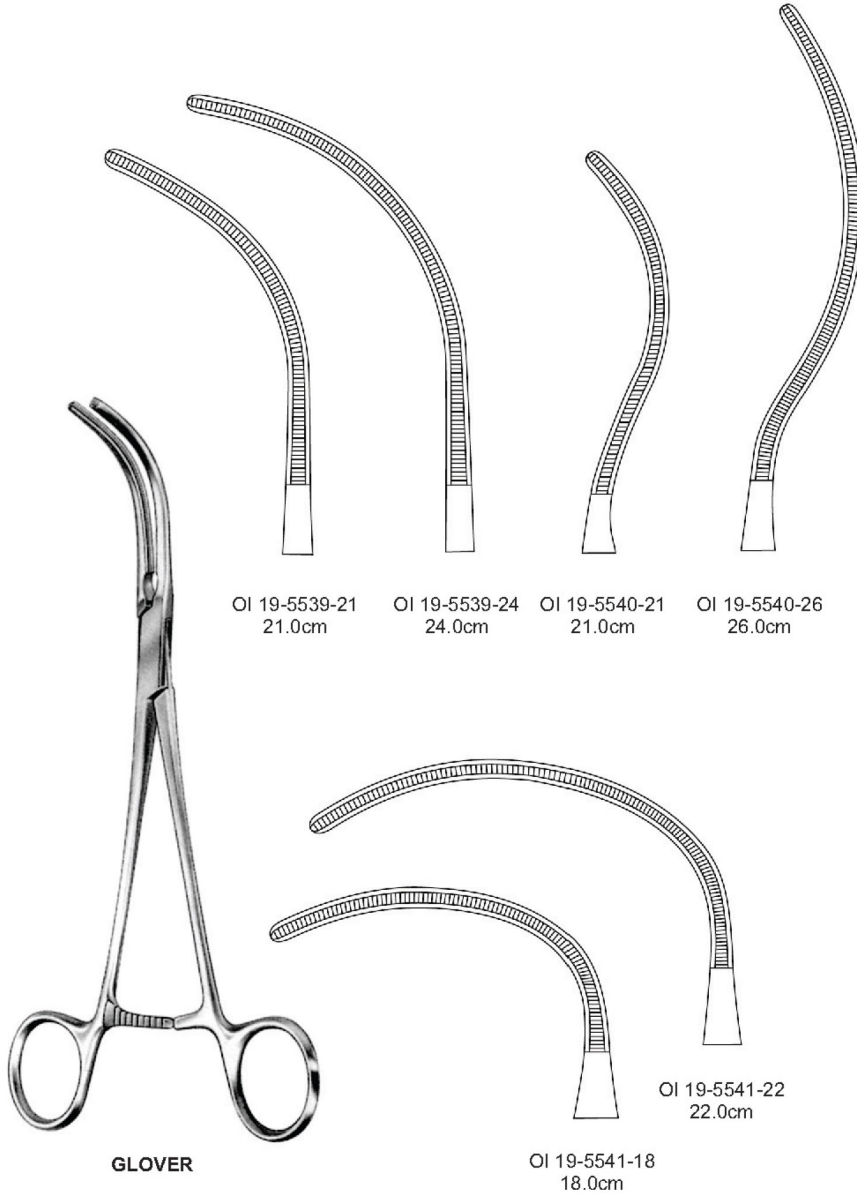

Dissecting and
 Ligature Forceps

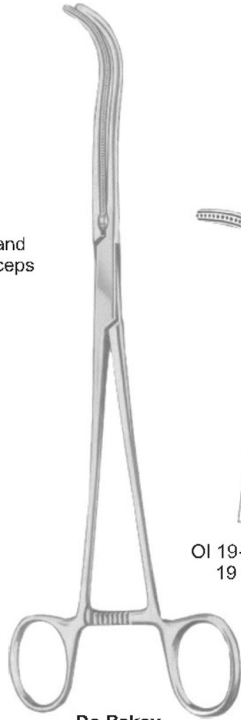

De Bakey

OI 19-5543-19
 19 cm/8"



OI 19-5543-23
 23 cm/9 1/2"



De Bakey

OI 19-5544-20
 20 cm/8"



OI 19-5544-18
 18 cm/7 1/2"



De Bakey



Leland-Jones

OI 19-5545-01
 19.5 cm/7 1/2"

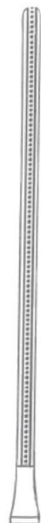

OI 19-5545-02
 19.5 cm/7 1/2"



OI 19-5545-03
 19.5 cm/7 1/2"

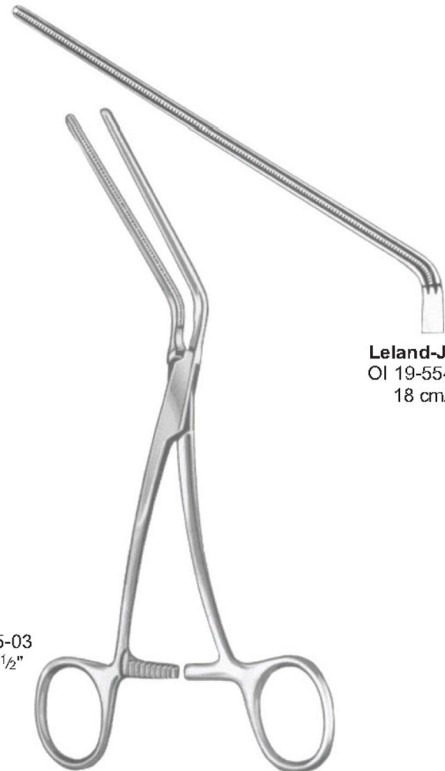
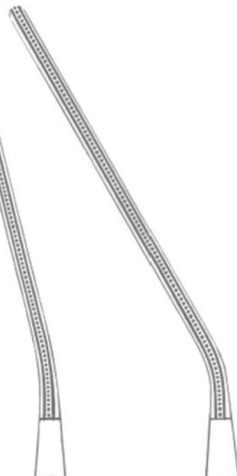

Leland-Jones
 OI 19-5546-18
 18 cm/7"





Aortic Aneurysm Clamps



De Bakey



De Bakey



OI 19-5547-24
26 cm/10 1/2"



OI 19-5547-27
27 cm/10 1/2"

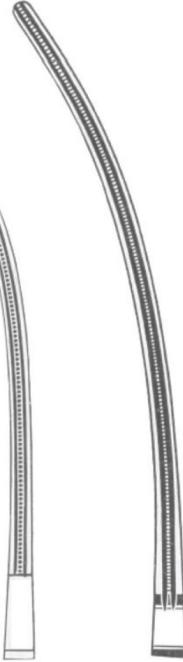

OI 19-5547-31
31 cm/12 1/4"



OI 19-5547-33
33 cm/13 1/4"



De Bakey-Bainbirdge



OI 19-5548-15
15 cm/6"



OI 19-5548-18
18 cm/7"



OI 19-5549-15
15 cm/6"



OI 19-5549-18
18 cm/7"



De Bakey
OI 19-5549-20
20 cm/8"





De Bakey

Aortic Aneurysm Clamps



De Bakey
OI 19-5550-28
28 cm/11"

OI 19-5551-30
30 cm/12"



- EN —●— Atrauma Cardiovascular Forceps
- DE —●— Atrauma cardiovascular-klemmen
- ES —●— Atrauma cardiovasculaire Forceps



De Bakey

Aortic Clamps

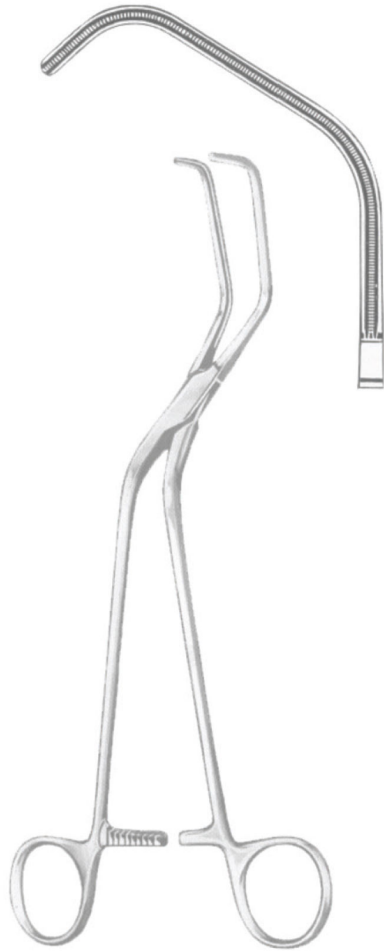

Ochsner
Ol 19-5552-23
23.5 cm/9 1/4"

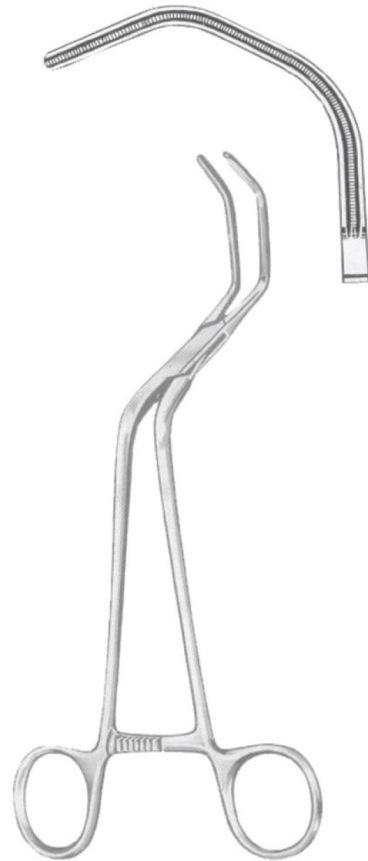

Dietrich
Ol 19-5553-21
21 cm/8 1/4"

Auricle Clamp



Harken



De Bakey



OI 19-5554-01
24 cm/9½"



OI 19-5554-02
24 cm/9½"



OI 19-5554-03
24 cm/9½"



OI 19-5554-04
24 cm/9½"



- EN — Atrauma Cardiovascular Forceps
- DE — Atrauma cardiovascular-klemmen
- ES — Atrauma cardiovascular Forceps



De Bakey

Bronchus Clamps



Lees



Lees
OI 19-5560-25
25 cm/10"



De Bakey

Aortic Clamp



De Bakey
OI 19-5561-27
27 cm/10½"

Ligature Clamps

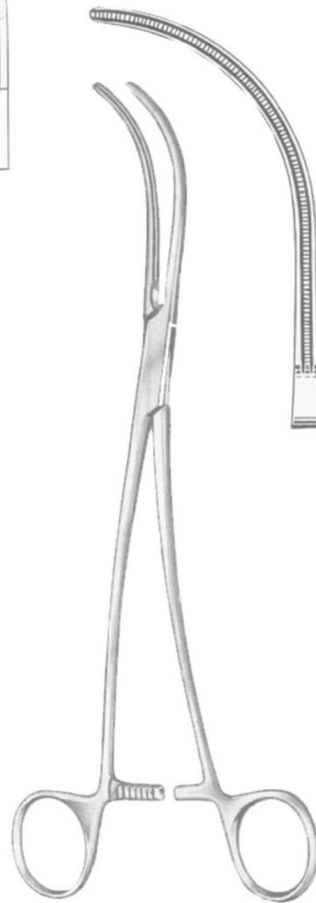

De Bakey
OI 19-5562-24
24 cm/9½"

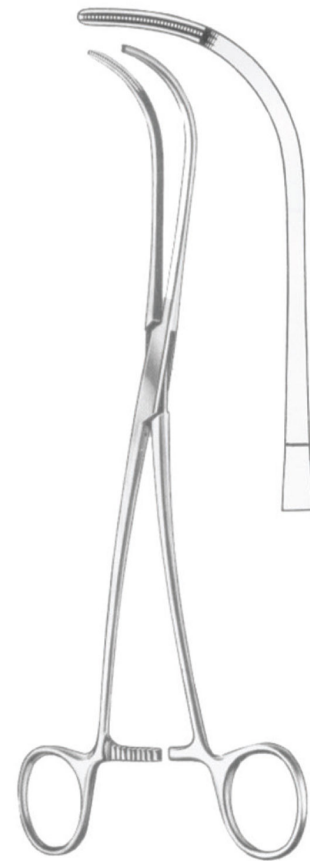

De Bakey
OI 19-5563-24
24 cm/9½"





De Bakey

Ligature clamp,
Aortic clamp



De Bakey
 OI 19-5564-26
 26.5 cm/10½"

De Bakey-Semb
 OI 19-5564-25
 25 cm/10"

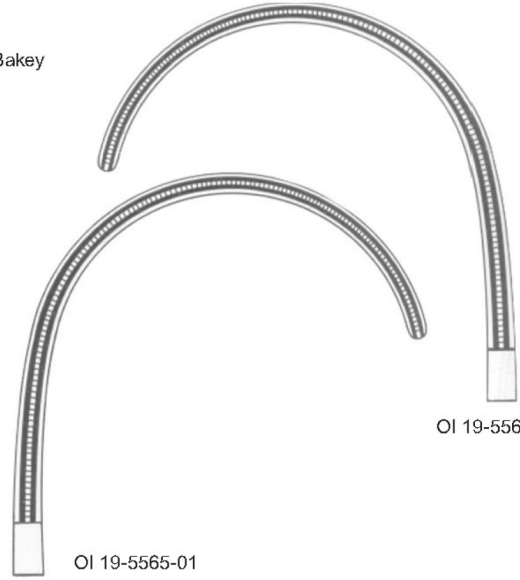

OI 19-5565-01

OI 19-5565-02

Aortic clamp

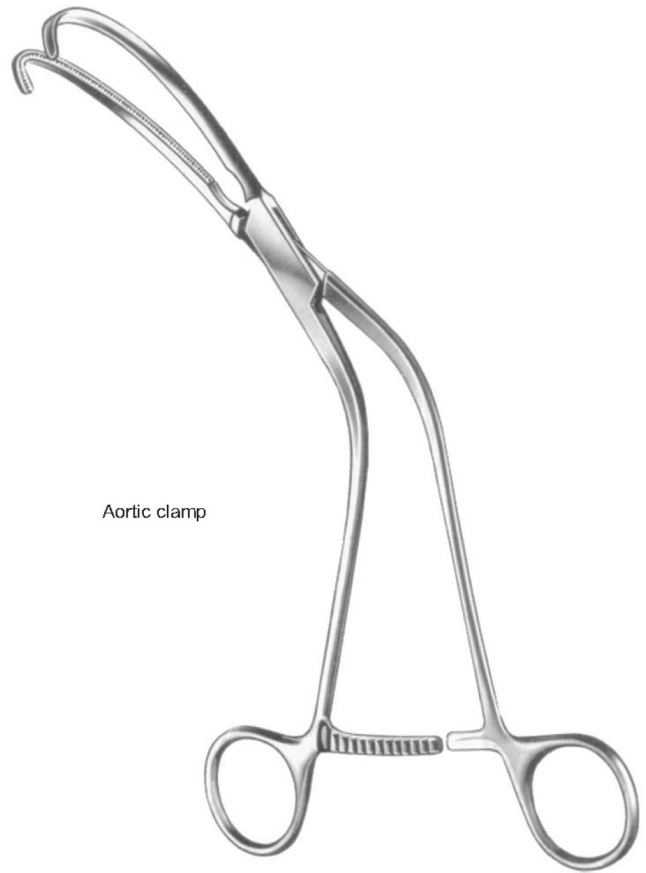

Weber
 26 cm/10¼"

De Bakey-Semb



Satinsky/De Bakey

Tangential occlusion clamps

Set of 5 purchase.
OI 19-5568-00

OI 19-5568-20
20 cm/8"

OI 19-5568-25
25 cm/10"

OI 19-5568-26
26 cm/10¼"

OI 19-5568-27
27 cm/10½"

OI 19-5568-28
28 cm/11"



De Bakey



Glover

OI 19-5569-01 19.5 cm/7¾"
 OI 19-5569-02 21.0 cm/8¼"

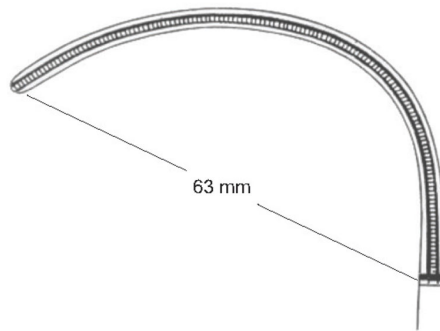

Anastomosis

63 mm

OI 19-5569-01

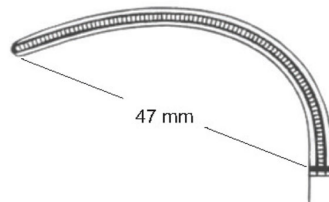

47 mm

OI 19-5569-02



- EN — Atrauma Cardiovascular Forceps
- DE — Atrauma cardiovascular-klemmen
- ES — Atrauma pinzas-clamps cardiovasculares



De Bakey



De Bakey
OI 19-5570-16
16 cm/6 1/4"

Graduated

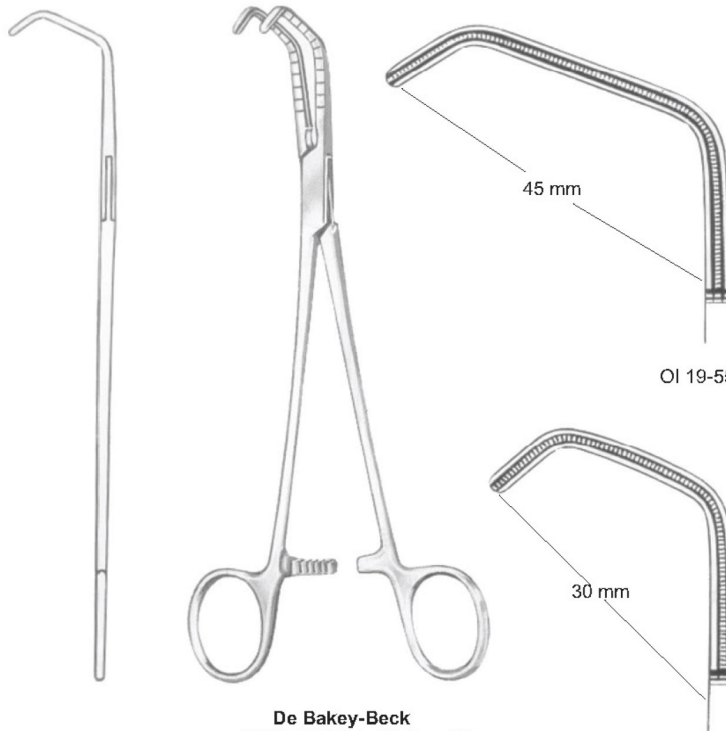

De Bakey-Beck
OI 19-5571-01 20.5 cm/8"
OI 19-5571-02 21.0 cm/8 1/4"

OI 19-5571-02

OI 19-5571-01



De Bakey



Lambert-Kay
 21 cm/8 1/4"



Aortic anastomosis clamps

OI 19-5572-21

OI 19-5572-22

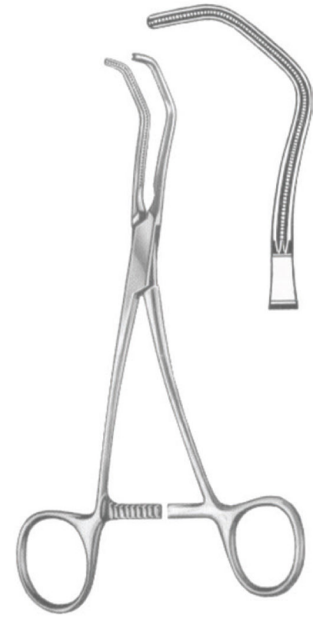

De Bakey
 OI 19-5573-17
 17 cm/6 3/4"



Beck
 OI 19-5574-17
 17 cm/6 3/4"



- EN — Atrauma Cardiovascular Forceps
- DE — Atrauma cardiovascular-klemmen
- ES — Atrauma pinzas-clamps cardiovasculares



De Bakey



OI 19-5575-20
20 cm/8"

OI 19-5575-22
22 cm/8 3/4"

OI 19-5575-24
24 cm/9 1/2"

OI 19-5575-30
30.5 cm/12"

Multi purpose clamps

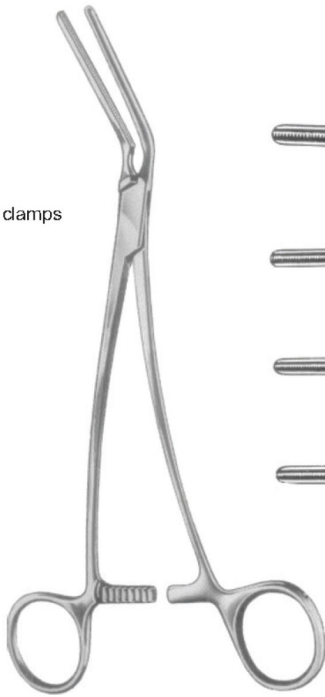

De Bakey

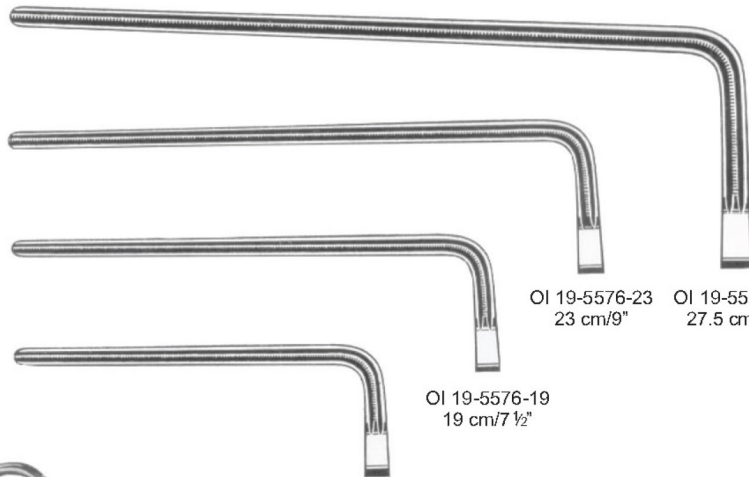

OI 19-5576-18
18 cm/7"

OI 19-5576-19
19 cm/7 1/2"

OI 19-5576-23
23 cm/9"

OI 19-5576-27
27.5 cm/11"



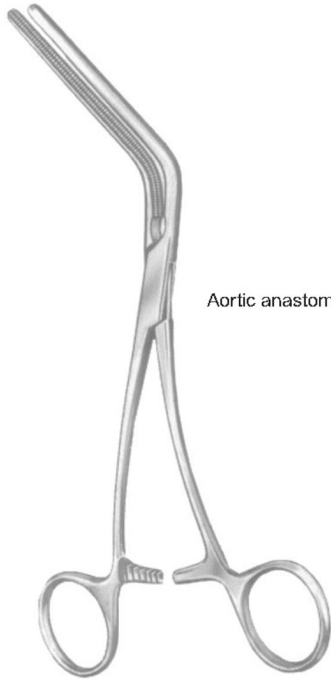

Aortic anastomosis clamps

Morris-De Bakey

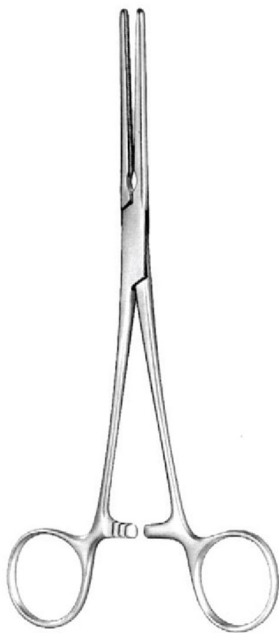
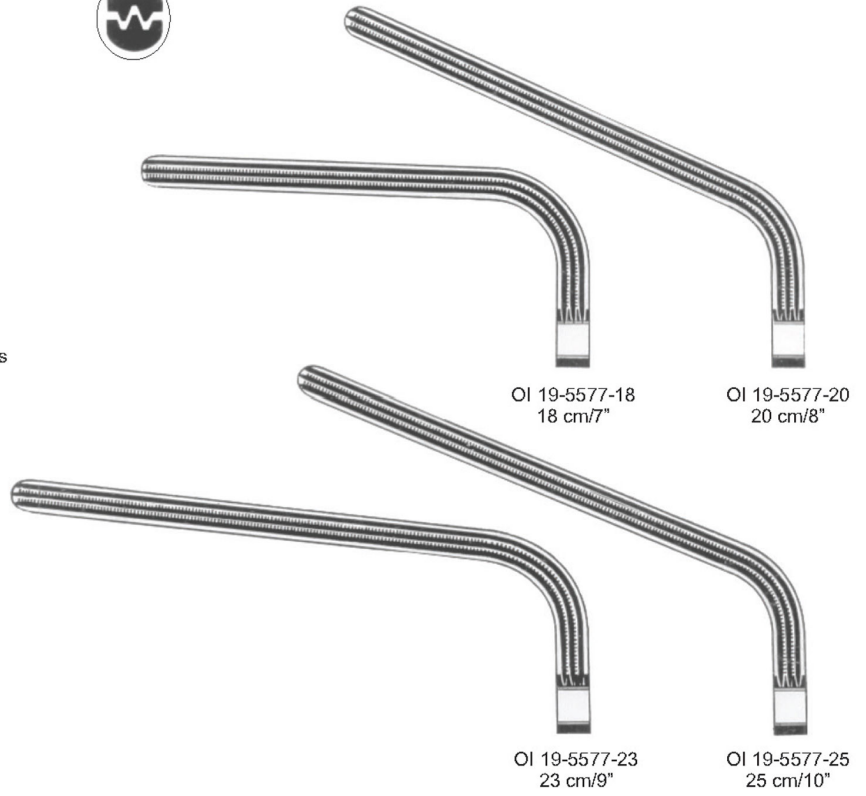

DE BAKEY-PEAN

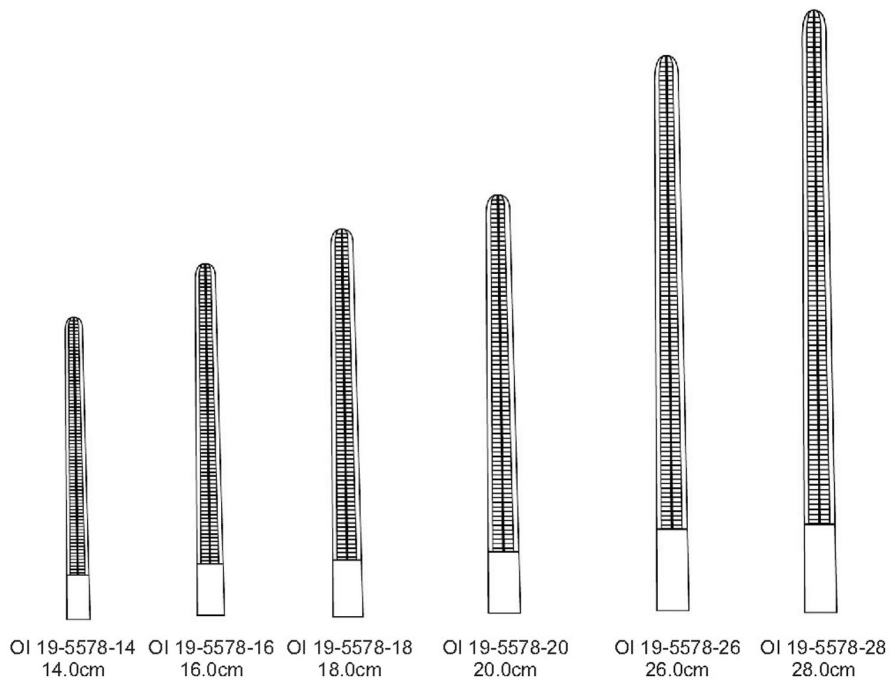



Aorta aneurysm clamps



De Bakey



De Bakey-Bahnson



OI 19-5579-23
23 cm/9"



OI 19-5579-24
24 cm/9½"



OI 19-5579-25
25 cm/10"



DE BAKEY-PEAN



OI 19-5580-14
14.0cm

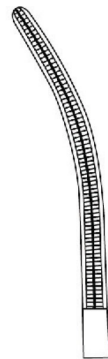

OI 19-5580-16
16.0cm

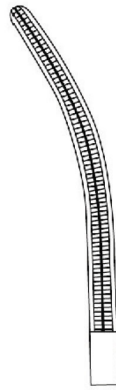

OI 19-5580-18
18.0cm

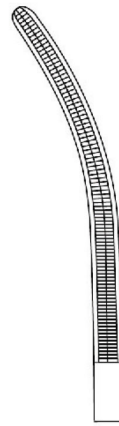

OI 19-5580-20
20.0cm

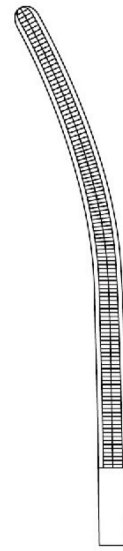

OI 19-5580-26
26.0cm

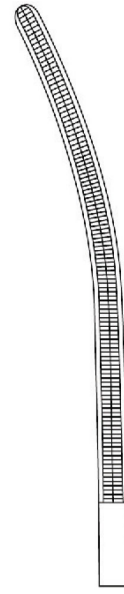

OI 19-5580-28
28.0cm

Multi purpose clamps



De Bakey

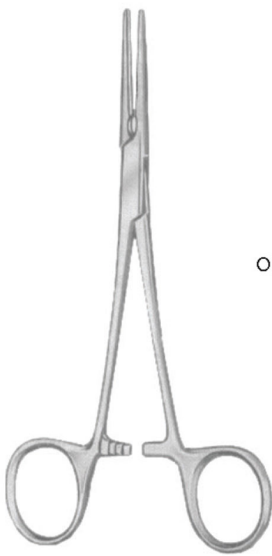

De Bakey-Rankin



OI 19-5581-16
16 cm/6 1/4"



OI 19-5582-16
16 cm/6 1/4"



Cooley



OI 19-5583-16
16 cm/6 1/4"

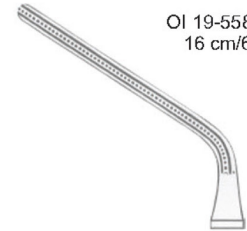

OI 19-5583-15
15.5 cm/6"



OI 19-5583-14
14.5 cm/5 3/4"



De Bakey
OI 19-5584-17
17 cm/6 3/4"

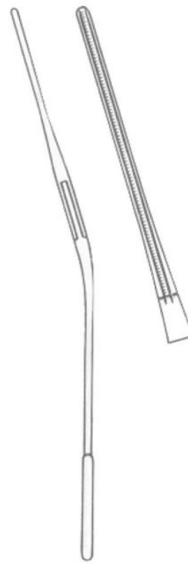

OI 19-5585-17

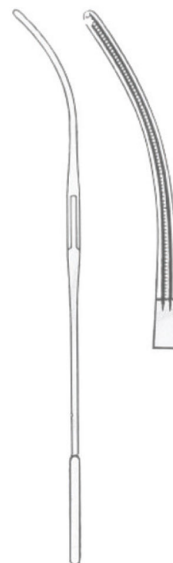

OI 19-5586-17

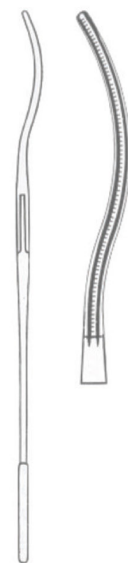

OI 19-5587-17





De Bakey

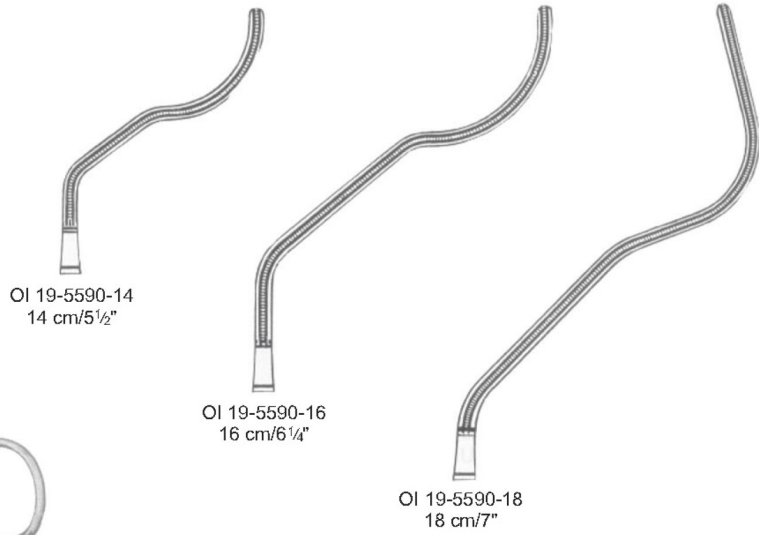
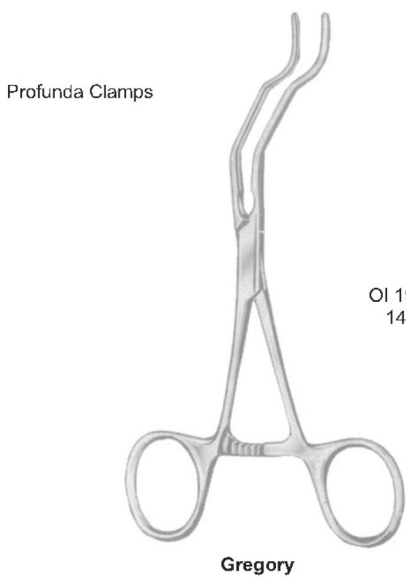
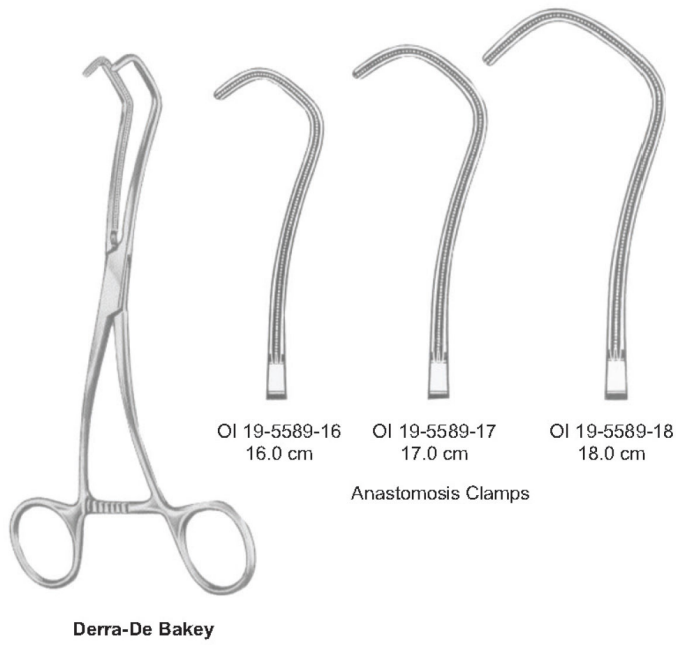
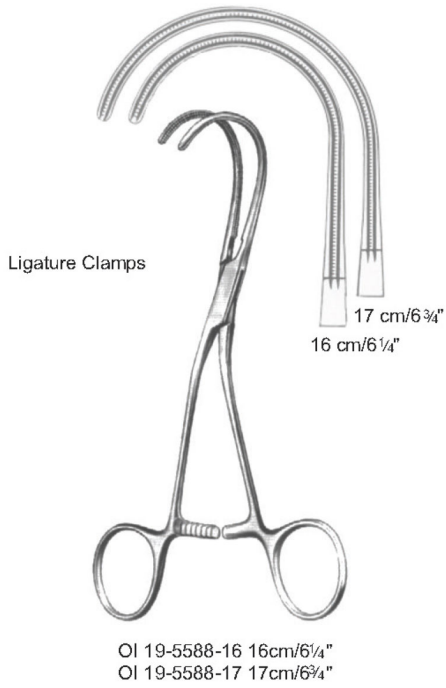



Cooley

Coarctation Clamps

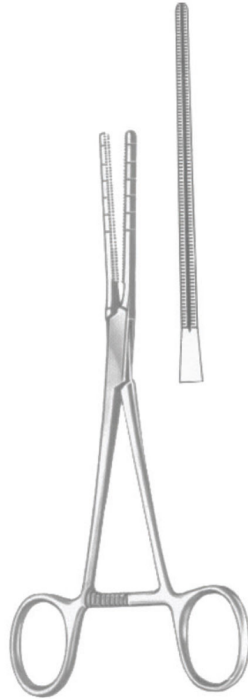

Cooley
OI 19-5591-17
17 cm/6¾"

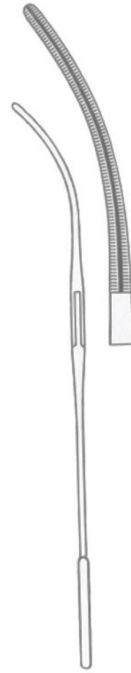

Cooley
OI 19-5592-17
17 cm/6¾"

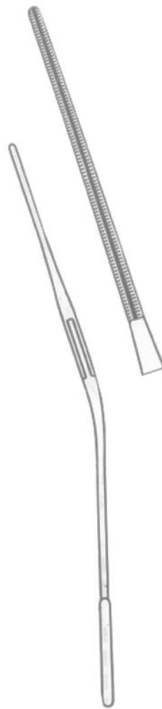

Cooley
OI 19-5593-17
17 cm/6¾"

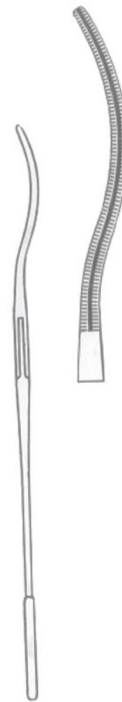

Cooley
OI 19-5594-17
17 cm/6¾"





Cooley
OI 19-5595-20
20 cm/8"



Cooley



Cooley



OI 19-5596-03
17 cm/6¾"



OI 19-5596-02
15.5 cm/6"



OI 19-5596-01
15 cm/6"

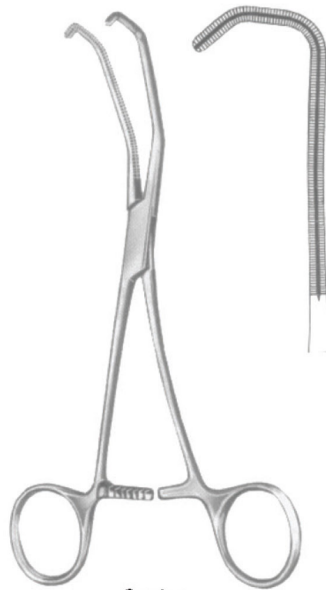

Cooley
OI 19-5599-17
17 cm/6¾"

Anastomosis clamps



Cooley



Cooley



OI 19-5600-01
 16.5 cm/6 1/2"

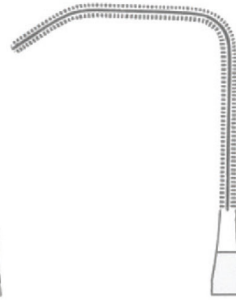

OI 19-5600-02
 16.5 cm/6 1/2"

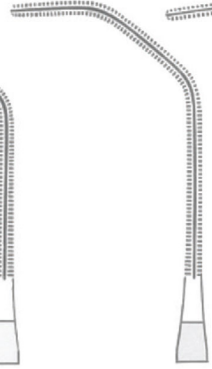

OI 19-5600-03
 17.5 cm/7"



OI 19-5600-04
 17.5 cm/7"

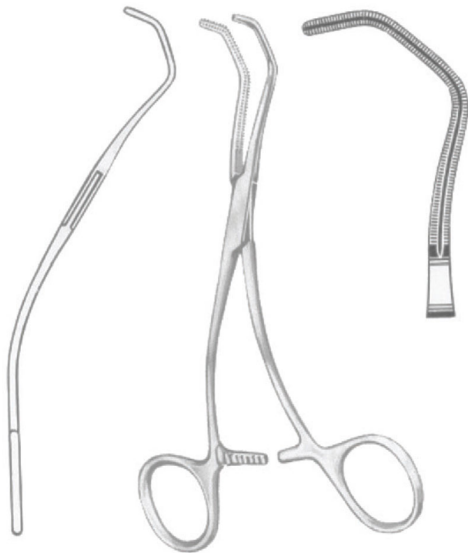

Cooley
 OI 19-5601-16
 16 cm/6 1/4"

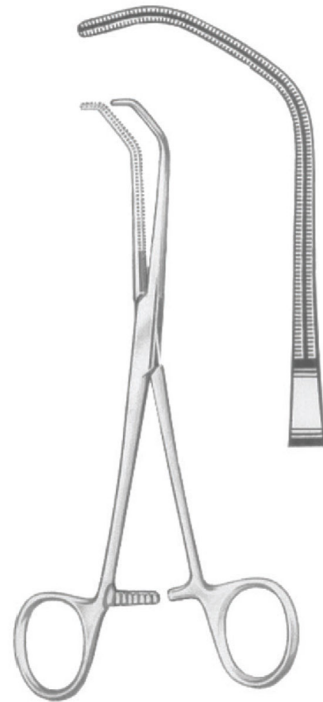

Beck
 OI 19-5602-17
 17 cm/6 3/4"



- EN —●— Atrauma Cardiovascular Forceps
- DE —●— Atrauma cardiovascular-klemmen
- ES —●— Atrauma pinzas-clamps cardiovasculares



Cooley



Cooley-Derra

OI 19-5603-16
16 cm/6 1/4"

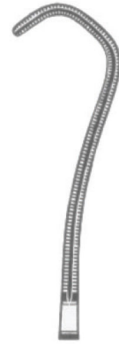

OI 19-5603-17
17 cm/6 3/4"



OI 19-5603-18
18 cm/7"



Cooley

OI 19-5604-16 16 cm/6 1/4"
OI 19-5604-17 17 cm/6 3/4"



16 cm/6 1/4"

17 cm/6 3/4"

Ligature clamps



Cooley
 14 cm/5½"

OI 19-5605-14 OI 19-5606-14



Cooley
 OI 19-5607-14
 14 cm/5½"



Cooley
 OI 19-5608-14
 14 cm/5½"



Cooley
 OI 19-5609-14
 14 cm/5½"



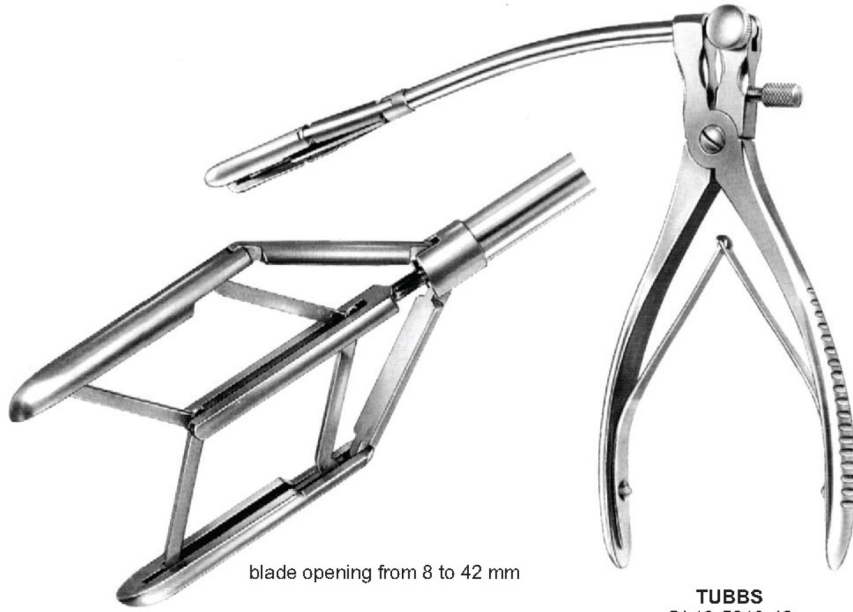

blade opening from 8 to 42 mm

TUBBS
OI 19-5610-42

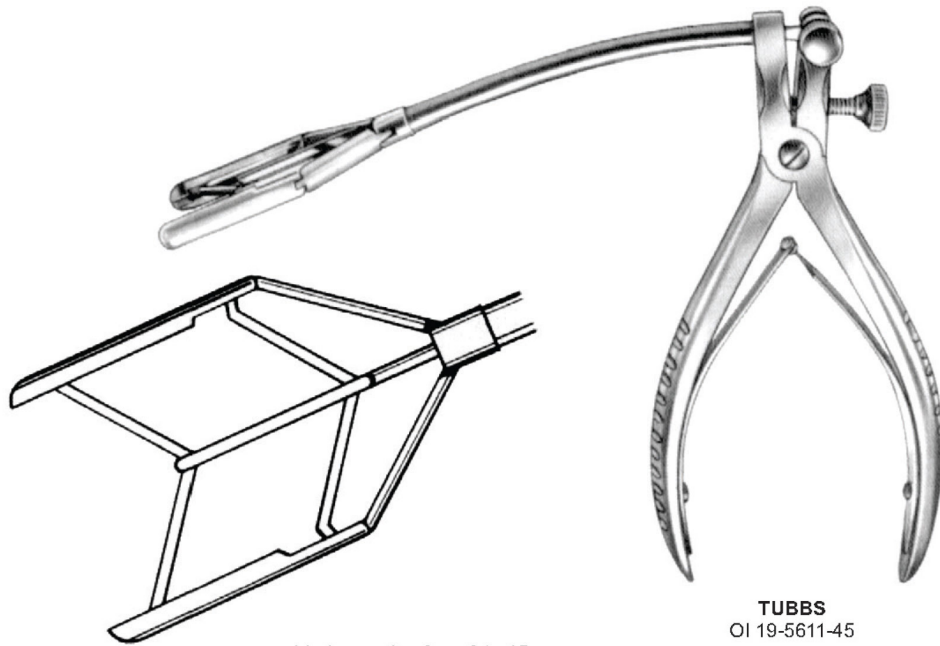

blade opening from 9 to 45 mm

TUBBS
OI 19-5611-45

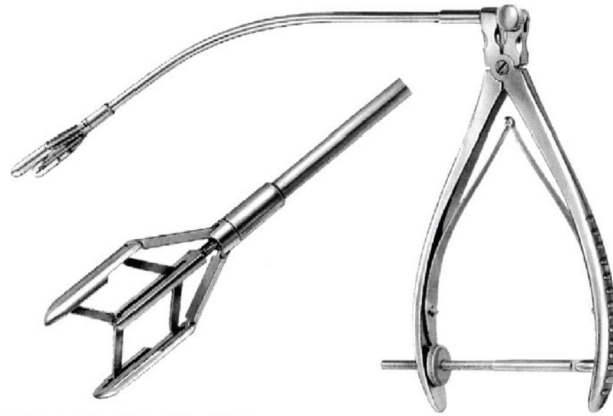

blade opening from 8 to 15 mm
 blade opening from 8 to 45 mm

COOLEY
 OI 19-5612-15
 OI 19-5612-45

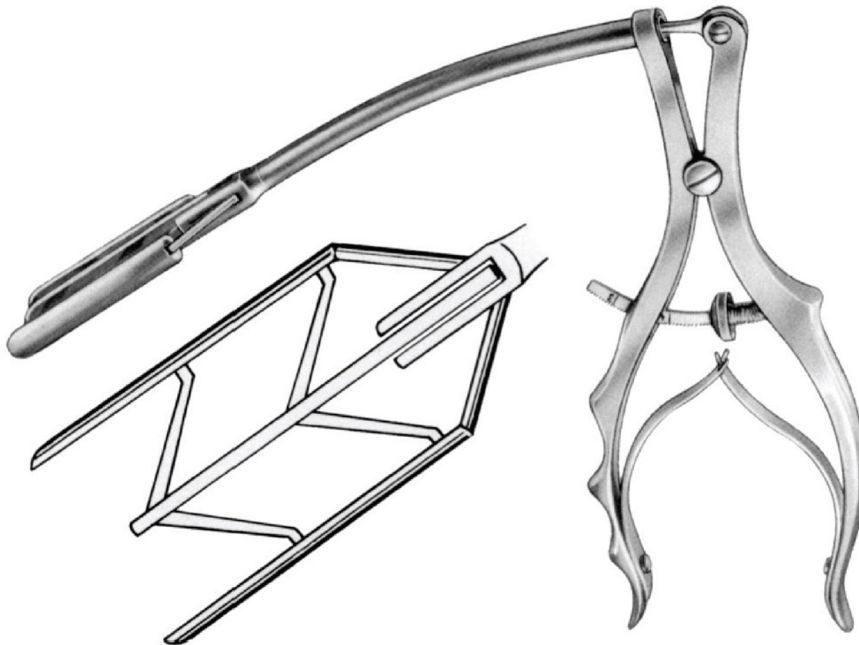

COOLEY
 OI 19-5613-40
 blade opening 9 - 40mm

COOLEY-DEBAKEY
 OI 19-5614-30
 blade opening 7 - 30mm



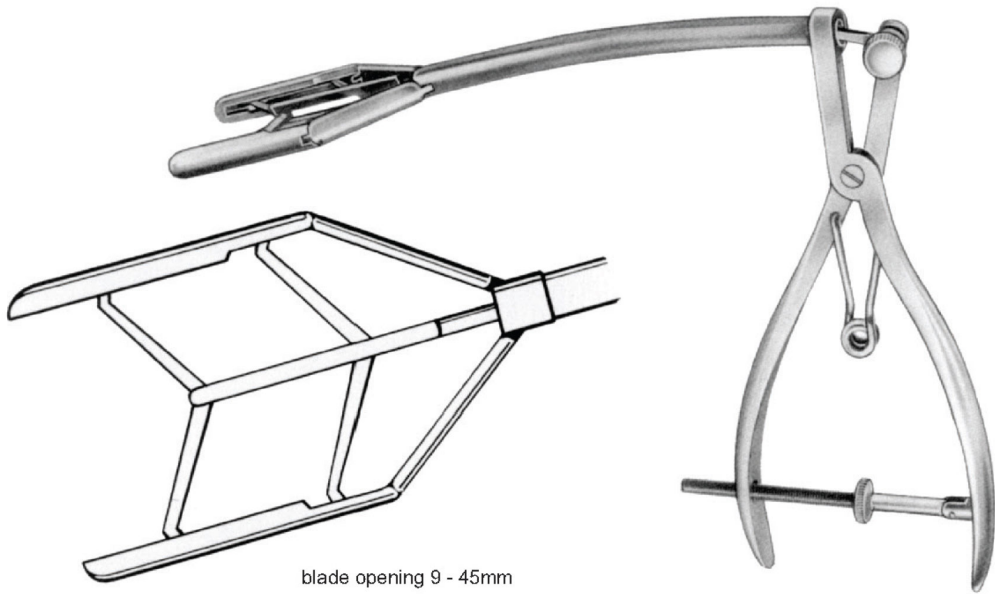

blade opening 9 - 45mm

GERBODE
OI 19-5615-45



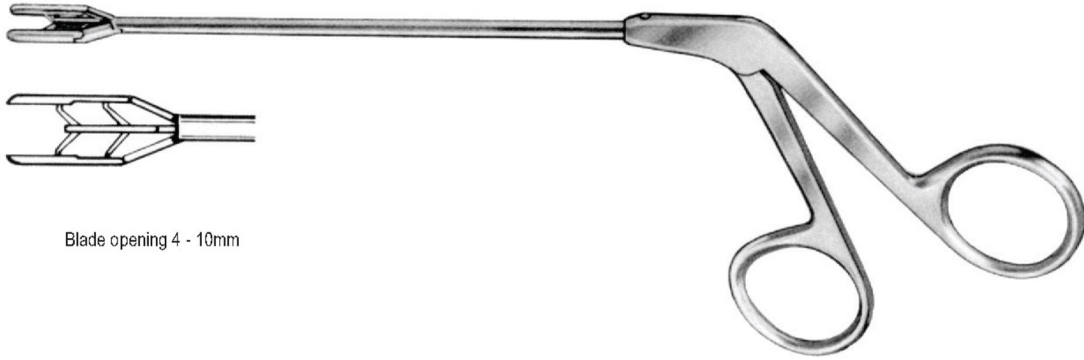

Blade opening 4 - 10mm

HETZER
OI 19-5616-10

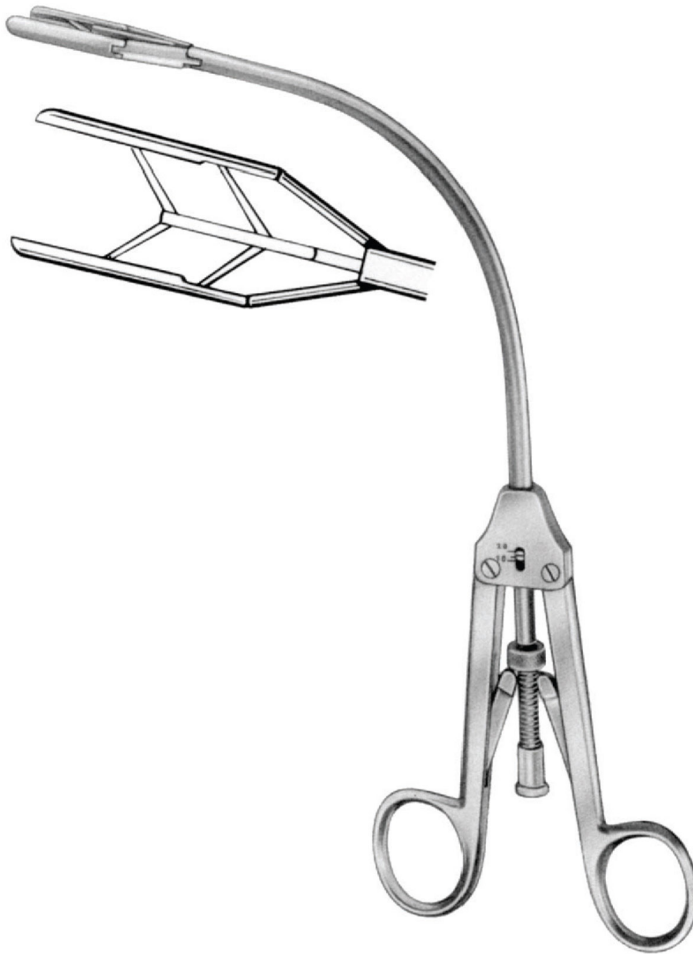

COOLEY blade opening
OI 19-5617-18 5 - 18mm
OI 19-5617-20 6 - 20mm



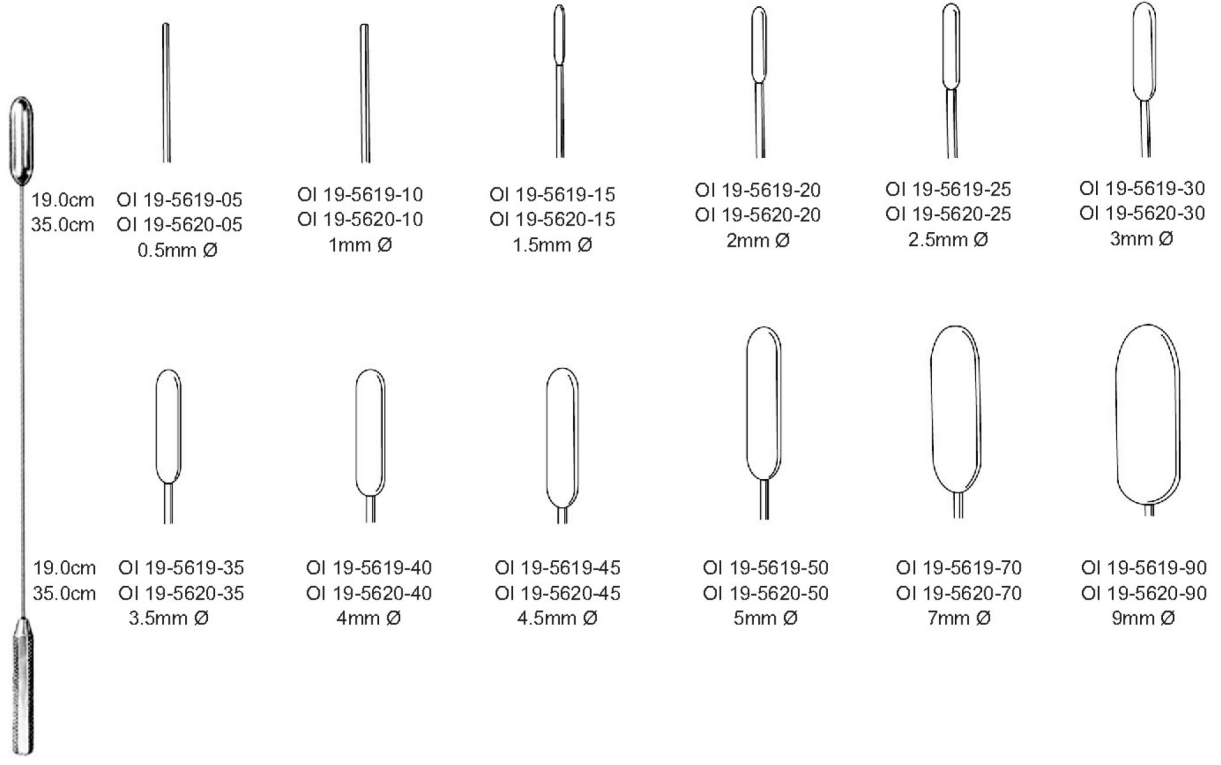

DE BAKEY

Malleable

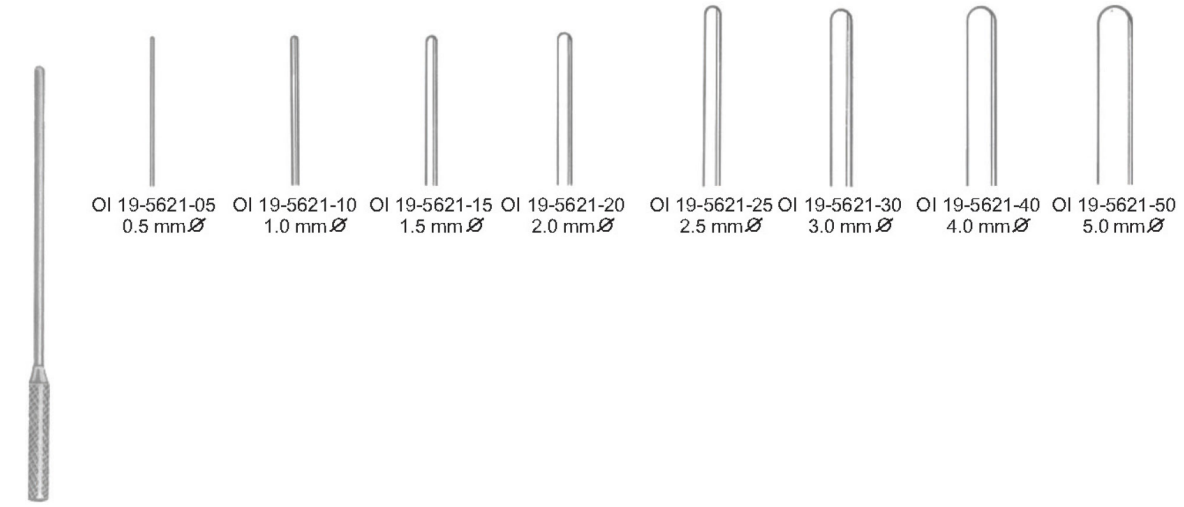

Cooley
13 cm/5"



Sauerbruch
 OI 19-5622-26
 26 cm/10 1/4"



Giertz-Stille
 OI 19-5623-27
 27 cm/10 1/2"

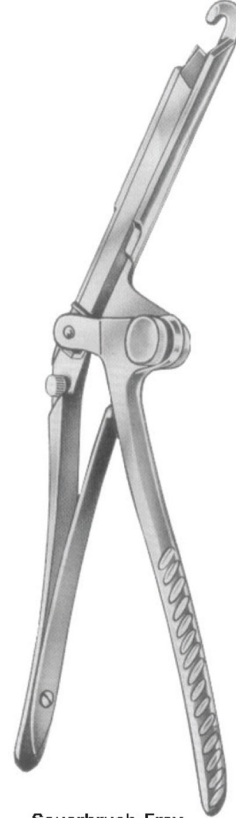

Sauerbruch-Frey
 OI 19-5624-36
 36 cm/14"



Bethune
 OI 19-5625-34
 34 cm/13 1/2"

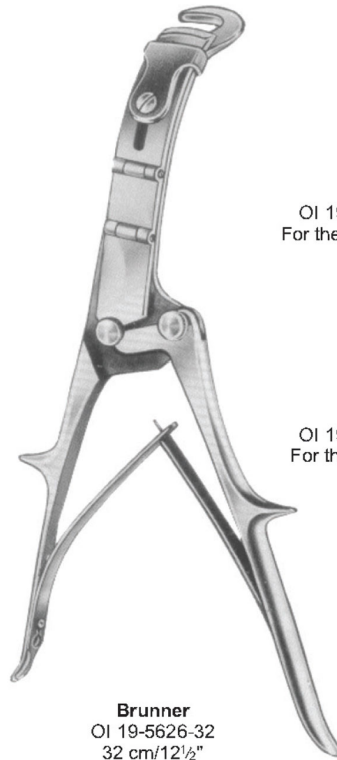

Brunner
 OI 19-5626-32
 32 cm/12 1/2"

OI 19-5626-32
 For the Right Hand

OI 19-5627-32
 For the left Hand



Lebsche
 OI 19-5628-24
 24.5 cm/9 3/4"



- EN — Bone and Rib Shears
- DE — Knochen-und Rippenscheren
- ES — Cizallas para huesos



CORYLLOS
OI 19-5629-35
35.0cm

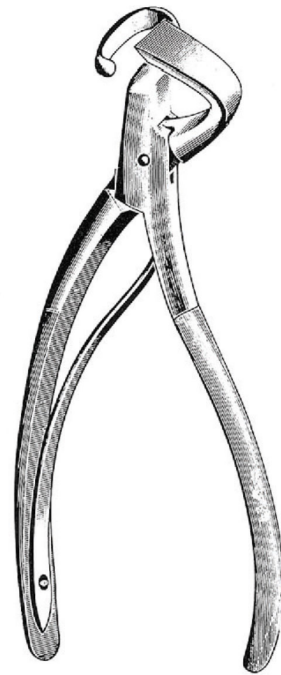

DOYEN
OI 19-5630-19
19.0cm



BETHUNE-NELSON
OI 19-5631-34
34.0cm
with probe ended blades

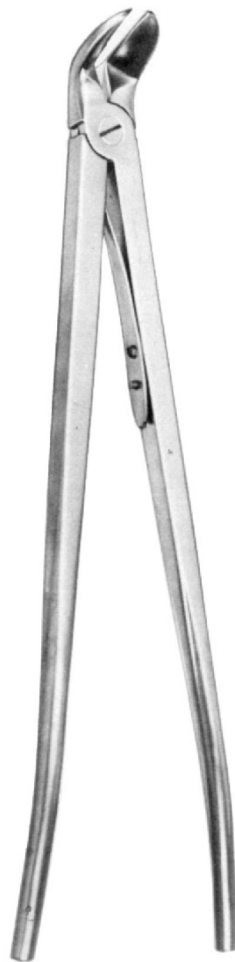

ROBERTS
OI 19-5632-34
34.0cm
with angular probe ended blades



ROBERTS
OI 19-5633-34
34.0cm
with angular probe ended
blades of first and second ribs





SCHUMACHER
 OI 19-5634-20
 20.0cm



TUDOR EDWARDS
 OI 19-5635-23
 23.0cm



Bone and Rib Shears ● EN
Knochen-und Rippenscheren ● DE
Cizallas para huesos ● ES



LEBSCHÉ
OI 19-5636-25
25.0cm



- EN — Rib Spreaders
- DE — Rippensperrer
- ES — Separadores costales



CASTAÑEDA

S/S

OI 19-5637-01

ALU

OI 19-5637-11

a

10.5mm

b

32mm

c

65mm

OI 19-5637-02

OI 19-5637-12

16mm

30mm

65mm

Scheme of dimensions

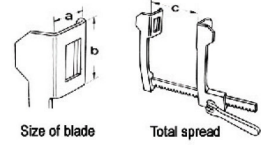

CASTAÑEDA

S/S

OI 19-5638-01

ALU

OI 19-5638-11

a

12mm

b

45mm

c

70mm



CASTAÑEDA

S/S

OI 19-5639-01

ALU

OI 19-5639-11

a

15mm

b

60mm

c

120mm

- EN — Rib Spreaders
- DE — Rippensperrer
- ES — Separadores costales



COOLEY
for neonatal
S/S **ALU** **a** **b** **c**
OI 19-5643-01 OI 19-5643-11 12mm 15mm 70mm

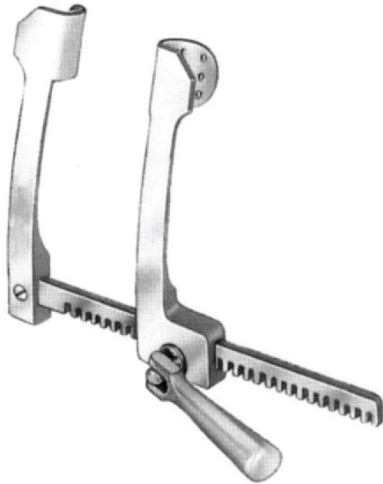

COOLEY
infant, sternal spreader
S/S **ALU** **a** **b** **c**
OI 19-5644-01 OI 19-5644-11 15mm 20mm 100mm



COOLEY
for babies
S/S **ALU** **a** **b** **c**
OI 19-5645-01 OI 19-5646-01 20mm 25mm 80mm

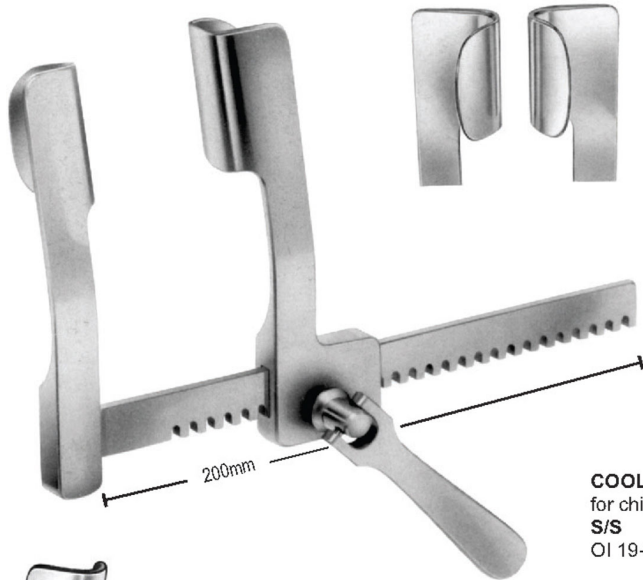

COOLEY
 for children
S/S **ALU** **a** **b** **c**
 OI 19-5647-01 OI 19-5648-01 21mm 45mm 145mm

for adult
 OI 19-5647-02 OI 19-5648-02 32mm 50mm 190mm

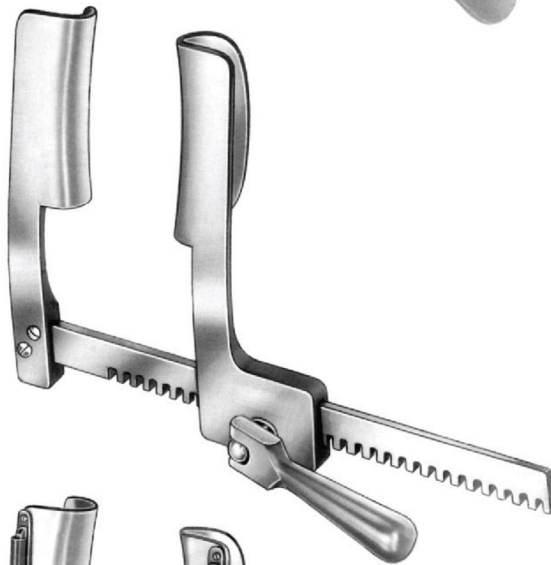

COOLEY
 for children
S/S **ALU** **a** **b** **c**
 OI 19-5649-01 OI 19-5650-01 35mm 100mm 180mm

for adult
 OI 19-5649-02 OI 19-5650-02 35mm 115mm 230mm



COOLEY
 for adults with suture separator
S/S **ALU** **a** **b** **c**
 OI 19-5651-01 OI 19-5652-01 35mm 100mm 180mm





H-COOLEY
with swivel convex blades, for babies
S/S ALU a b c
OI 19-5653-01 OI 19-5654-01 10mm 15mm 90mm



H-COOLEY
with swivel blades, for babies
S/S ALU a b c
OI 19-5655-02 OI 19-5656-02 10mm 15mm 90mm

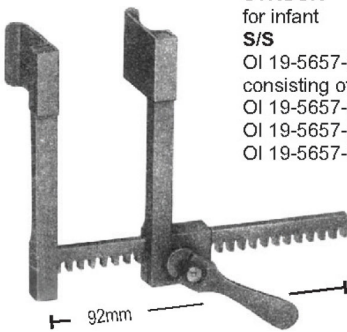

STRUCK
for infant
S/S ALU
OI 19-5657-00 OI 19-5657-01
consisting of spreader only
OI 19-5657-90 1 pair
OI 19-5657-04 1 pair
OI 19-5657-05 1 pair

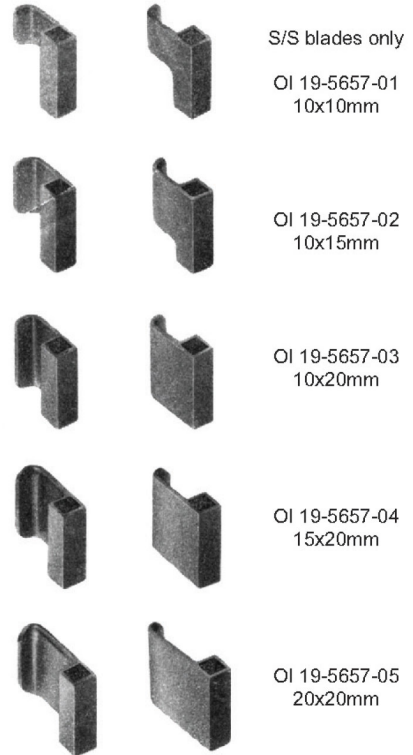

S/S blades only
OI 19-5657-01
10x10mm

OI 19-5657-02
10x15mm

OI 19-5657-03
10x20mm

OI 19-5657-04
15x20mm

OI 19-5657-05
20x20mm





WEINBERG
 for children
S/S **ALU** **a** **b** **c**
 OI 19-5658-01 OI 19-5659-01 12mm 20mm 95mm

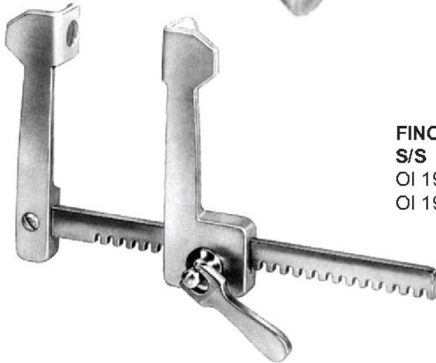

FINOCHIETTO-INFANT
S/S **ALU** **a** **b** **c**
 OI 19-5660-01 OI 19-5661-01 12mm 15mm 70mm
 OI 19-5660-02 OI 19-5661-02 15mm 15mm 75mm

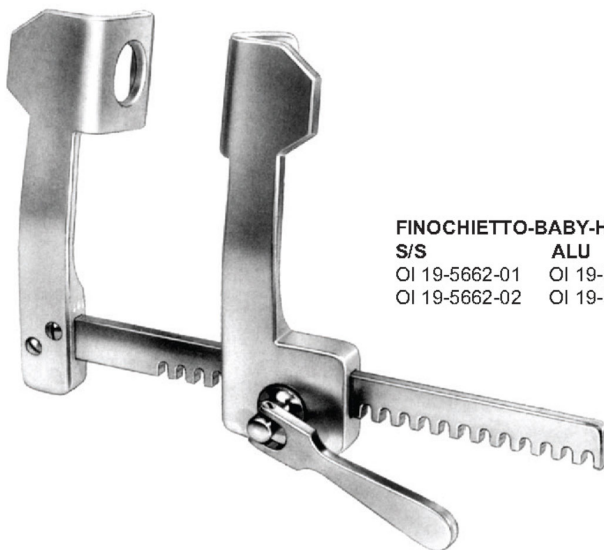

FINOCHIETTO-BABY-HAIGHT
S/S **ALU** **a** **b** **c**
 OI 19-5662-01 OI 19-5663-01 27mm 30mm 95mm
 OI 19-5662-02 OI 19-5663-02 31mm 31mm 100mm



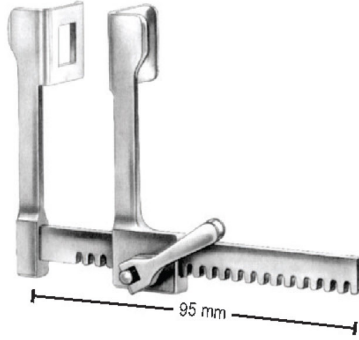

FINOCHIETTO-BABY

S/S	ALU	a	b	c
OI 19-5664-01	OI 19-5665-01	14mm	15mm	75mm
OI 19-5664-02	OI 19-5665-02	18mm	20mm	75mm

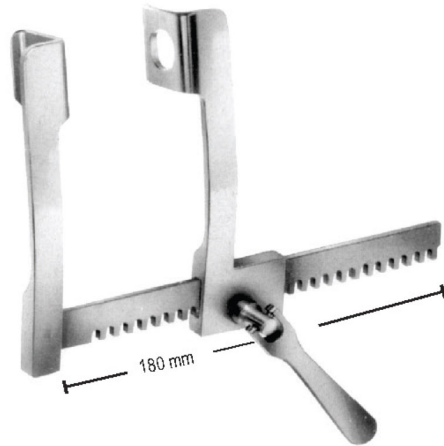

S/S	ALU	a	b	c
OI 19-5666-01	OI 19-5667-01	28mm	32mm	120mm



FINOCHIETTO

S/S	ALU	a	b	c
OI 19-5668-01	OI 19-5669-01	12mm	15mm	100mm
OI 19-5668-02	OI 19-5669-02	28mm	30mm	143mm
OI 19-5668-03	OI 19-5669-03	31mm	45mm	210mm
OI 19-5668-04	OI 19-5669-04	42mm	61mm	245mm
OI 19-5668-05	OI 19-5669-05	74mm	64mm	245mm



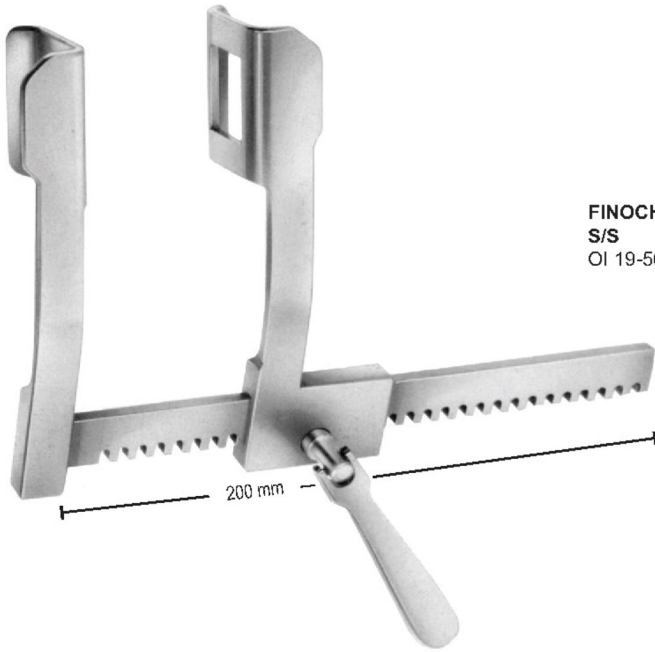

FINOCHIETTO
 S/S ALU
 OI 19-5670-01 OI 19-5671-01 a 36mm b 45mm c 140mm

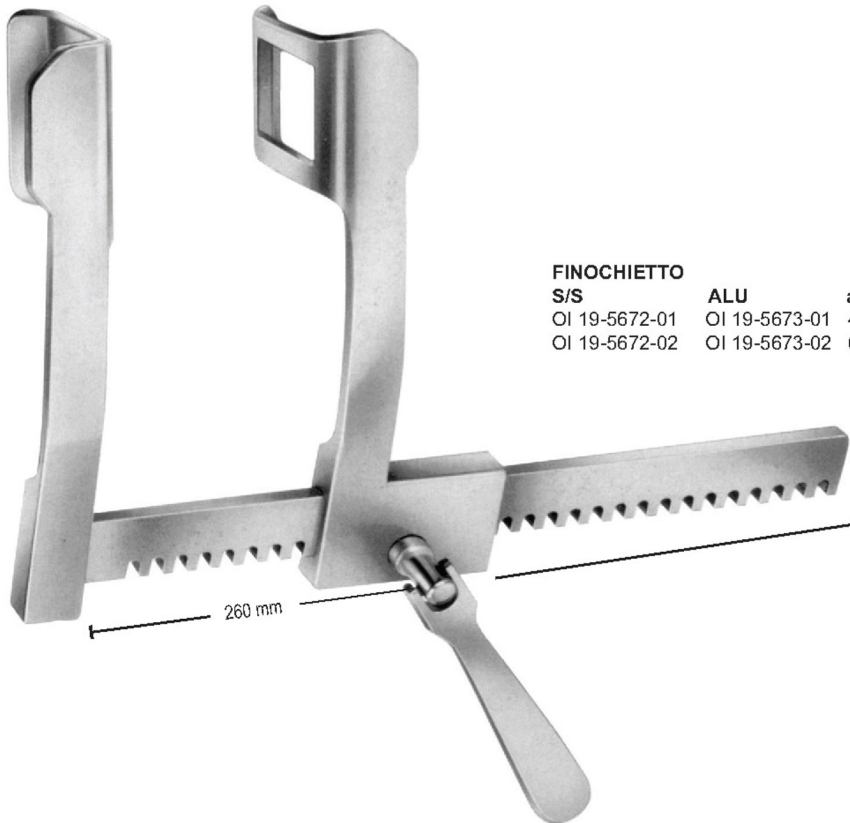

FINOCHIETTO
 S/S ALU
 OI 19-5672-01 OI 19-5673-01 a 44mm b 65mm c 210mm
 OI 19-5672-02 OI 19-5673-02 a 65mm b 65mm c 210mm

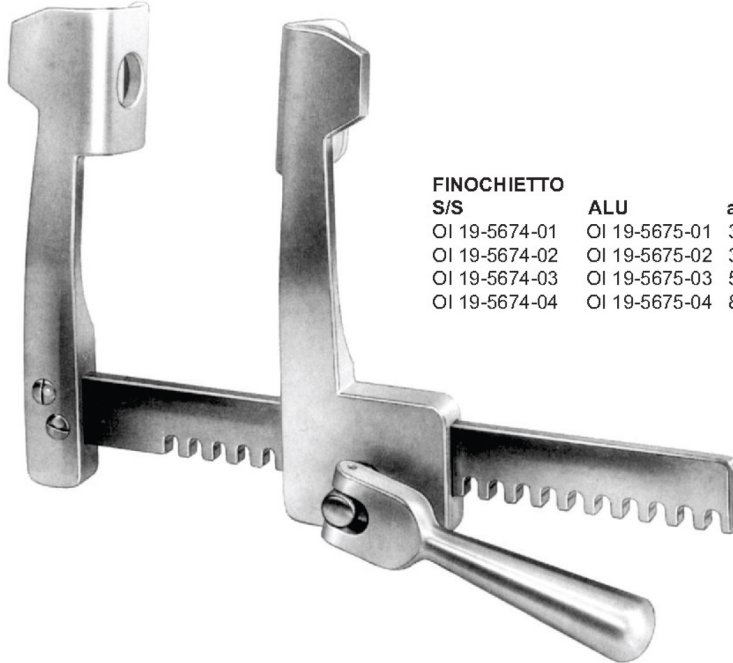

- EN — Rib Spreaders
 DE — Rippensperrer
 ES — Separadores costales

**FINOCHIETTO**

S/S	ALU	a	b	c
OI 19-5674-01	OI 19-5675-01	30mm	45mm	140mm
OI 19-5674-02	OI 19-5675-02	38mm	44mm	135mm
OI 19-5674-03	OI 19-5675-03	52mm	62mm	175mm
OI 19-5674-04	OI 19-5675-04	85mm	85mm	175mm

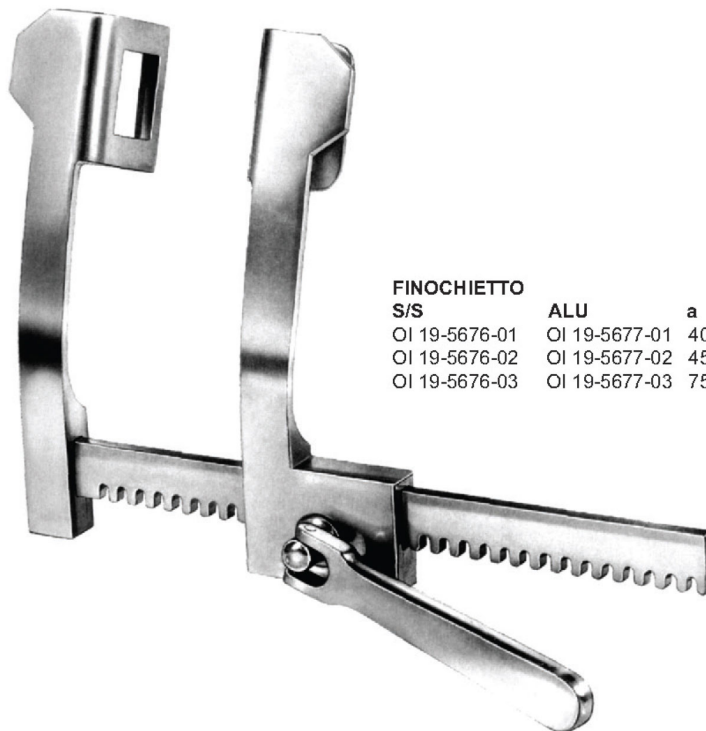
**FINOCHIETTO**

S/S	ALU	a	b	c
OI 19-5676-01	OI 19-5677-01	40mm	40mm	165mm
OI 19-5676-02	OI 19-5677-02	45mm	65mm	200mm
OI 19-5676-03	OI 19-5677-03	75mm	65mm	250mm

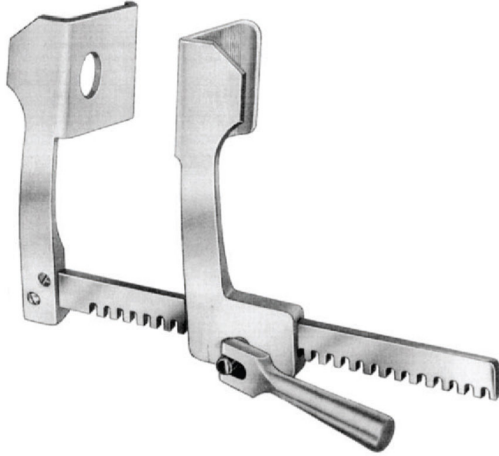

FINOCHIETTO
for adults

S/S	ALU	a	b	c
OI 19-5678-01	OI 19-5679-01	52mm	62mm	175mm
OI 19-5678-02	OI 19-5679-02	85mm	65mm	175mm



FINOCHIETTO
for adults, with suture separator

S/S	ALU	a	b	c
OI 19-5680-01	OI 19-5681-01	85mm	65mm	175mm



FINOCHIETTO
for adults, with 2 blades attached to each arm

S/S	ALU	a	b	c
OI 19-5682-01	OI 19-5683-01	10mm	15mm	120mm
OI 19-5682-02	OI 19-5683-02	14mm	14mm	120mm
OI 19-5682-03	OI 19-5683-03	14mm	20mm	120mm

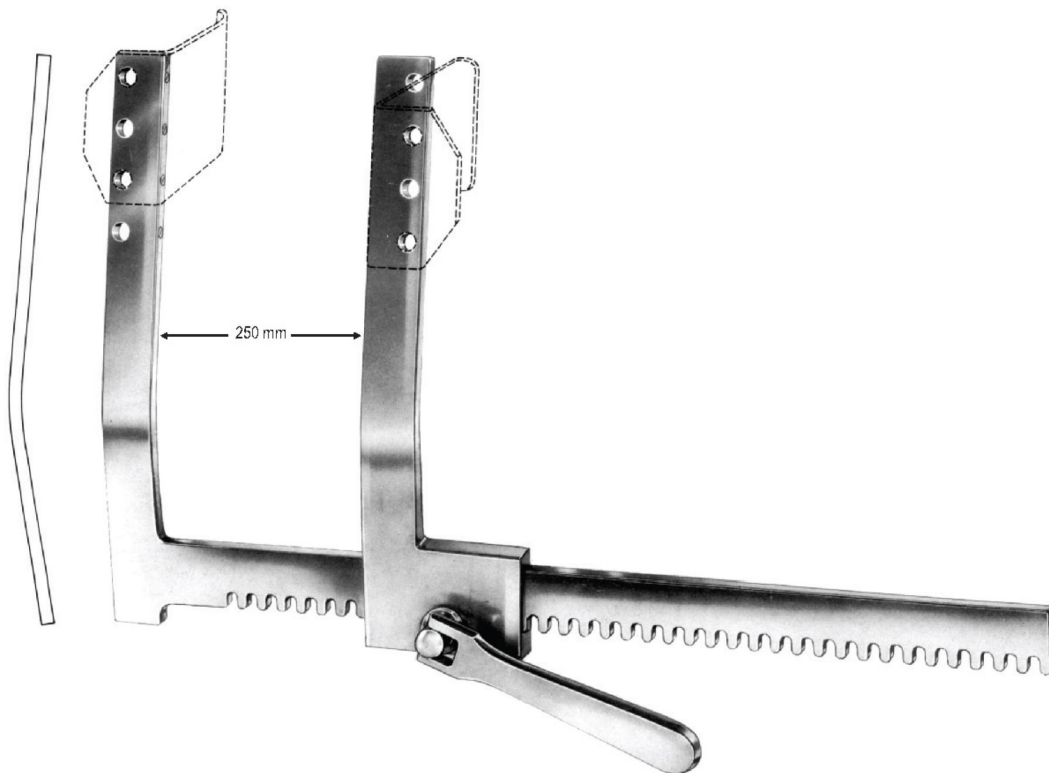

**FINOCHIETTO**

3 pairs of exchangeable blades

S/S	ALU	S/S	ALU
OI 19-5684-00	OI 19-5685-00	OI 19-5686-00	OI 19-5687-00
blades		blades	
OI 19-5684-30	OI 19-5685-30	OI 19-5686-40	OI 19-5687-40
OI 19-5684-40	OI 19-5685-40	OI 19-5686-50	OI 19-5687-50
OI 19-5684-50	OI 19-5685-50	OI 19-5686-60	OI 19-5687-60
frame only 150mm		frame only 250mm	
OI 19-5684-01	OI 19-5685-01	OI 19-5686-01	OI 19-5687-01

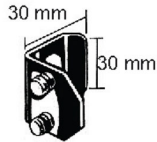

S/S Alu
 OI 19-5684-30 OI 19-5685-30
 30x30mm

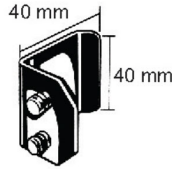

S/S Alu
 OI 19-5684-40 OI 19-5685-40
 40x40mm

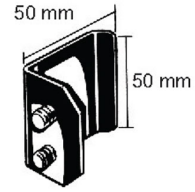

S/S Alu
 OI 19-5684-50 OI 19-5685-50
 50x50mm

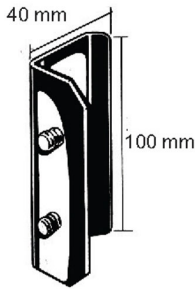

S/S Alu
 OI 19-5686-40 OI 19-5687-40
 40x100mm

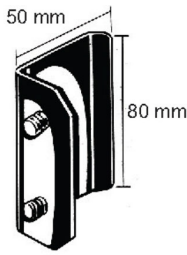

S/S Alu
 OI 19-5686-50 OI 19-5687-50
 50x80mm

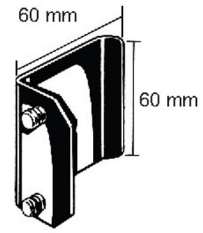

S/S Alu
 OI 19-5686-60 OI 19-5687-60
 60x60mm

Optional Exchangeable Blades

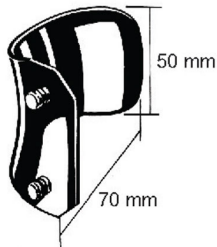

S/S Alu
 OI 19-5686-70 OI 19-5687-70
 70x50mm

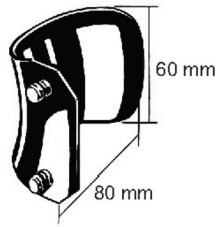

S/S Alu
 OI 19-5686-80 OI 19-5687-80
 80x60mm

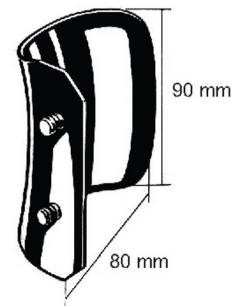

S/S Alu
 OI 19-5686-90 OI 19-5687-90
 80x90mm





BURFORD
for children
with 2 pairs of blades

S/S	ALU	a	b	c
OI 19-5688-01	OI 19-5689-01	30mm 41mm	42mm 42mm	130mm
OI 19-5688-02	OI 19-5689-02	34mm 48mm	42mm 42mm	135mm



BURFORD
for adults
with 2 pairs of blades

S/S	ALU	a	b	c
OI 19-5690-01	OI 19-5691-01	47mm 65mm	62mm 62mm	200mm
OI 19-5690-02	OI 19-5691-02	47mm 65mm	62mm 62mm	260mm
OI 19-5690-03	OI 19-5691-03	47mm 65mm	62mm 62mm	300mm



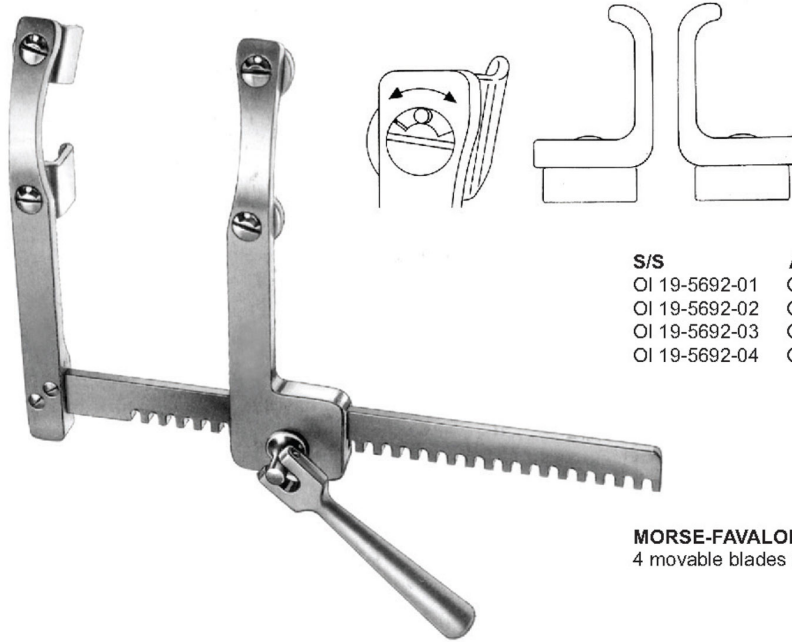

S/S	ALU	a	b	c
OI 19-5692-01	OI 19-5693-01	12mm	20mm	155mm
OI 19-5692-02	OI 19-5693-02	20mm	20mm	155mm
OI 19-5692-03	OI 19-5693-03	40mm	20mm	155mm
OI 19-5692-04	OI 19-5693-04	17mm	22mm	160mm

MORSE-FAVALORO
 4 movable blades for children

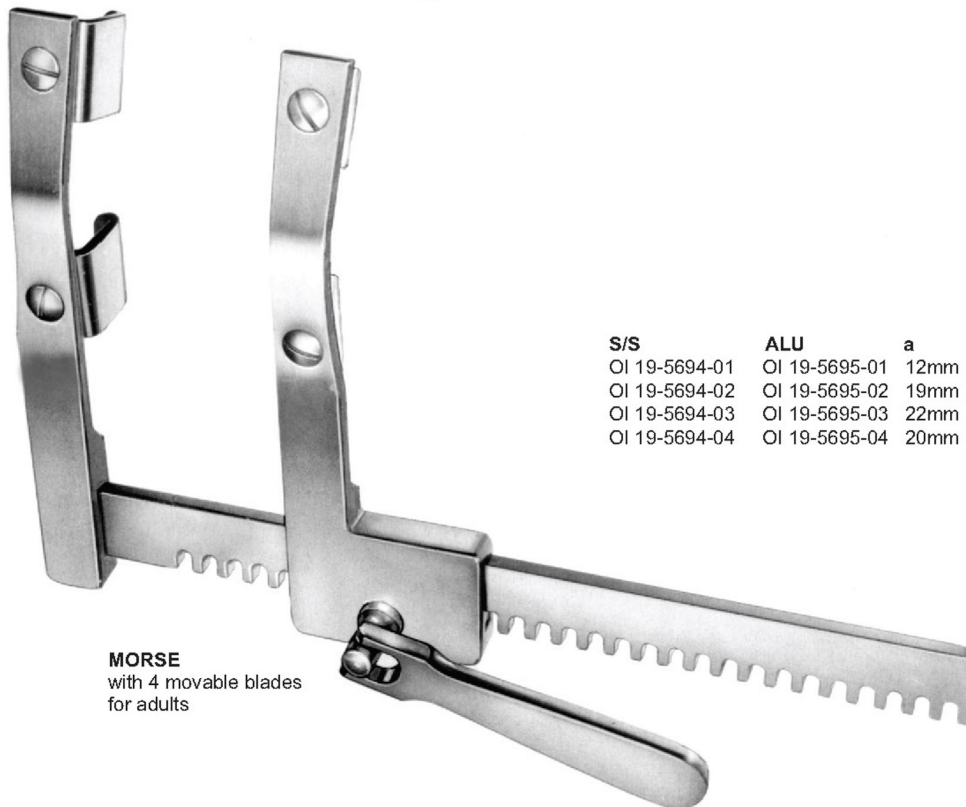

MORSE
 with 4 movable blades
 for adults

S/S	ALU	a	b	c
OI 19-5694-01	OI 19-5695-01	12mm	20mm	200mm
OI 19-5694-02	OI 19-5695-02	19mm	19mm	200mm
OI 19-5694-03	OI 19-5695-03	22mm	27mm	200mm
OI 19-5694-04	OI 19-5695-04	20mm	28mm	210mm





MORSE STERNAL

S/S	ALU	a	b	c
OI 19-5696-01	OI 19-5697-01	30mm	35mm	200mm

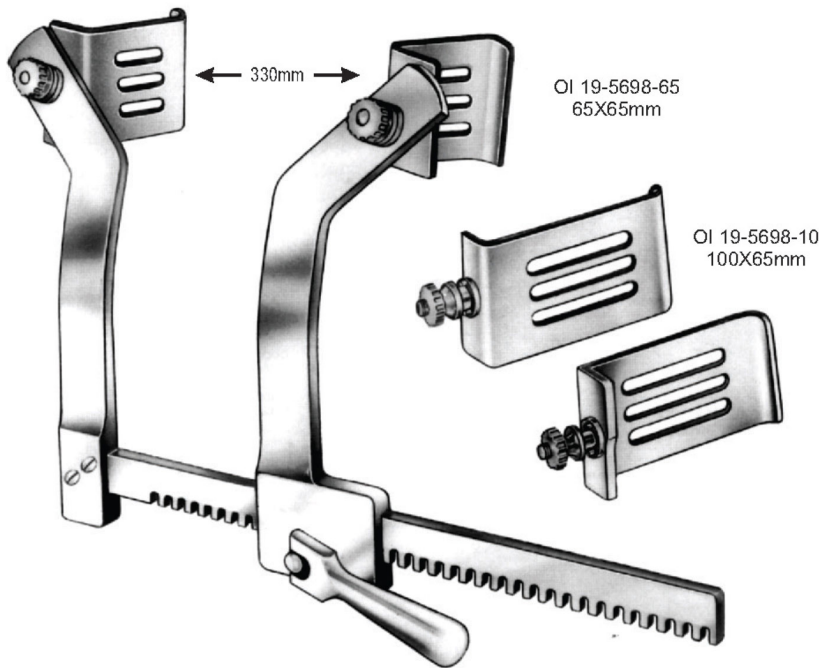

BRAASTAD

S/S	ALU
OI 19-5698-01	OI 19-5699-01
with 2 pairs of blades	
OI 19-5698-65	OI 19-5699-65
OI 19-5698-10	OI 19-5699-10



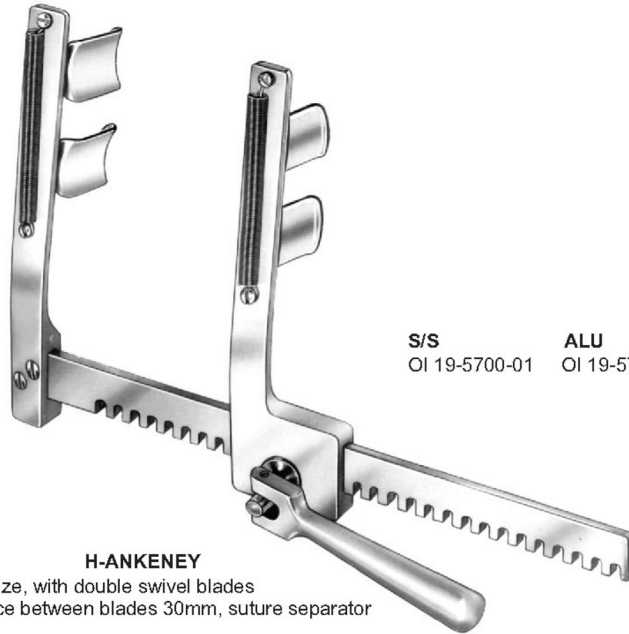

S/S	ALU	a	b	c
OI 19-5700-01	OI 19-5700-11	20mm	20mm	160mm

H-ANKENEY
 child size, with double swivel blades
 distance between blades 30mm, suture separator

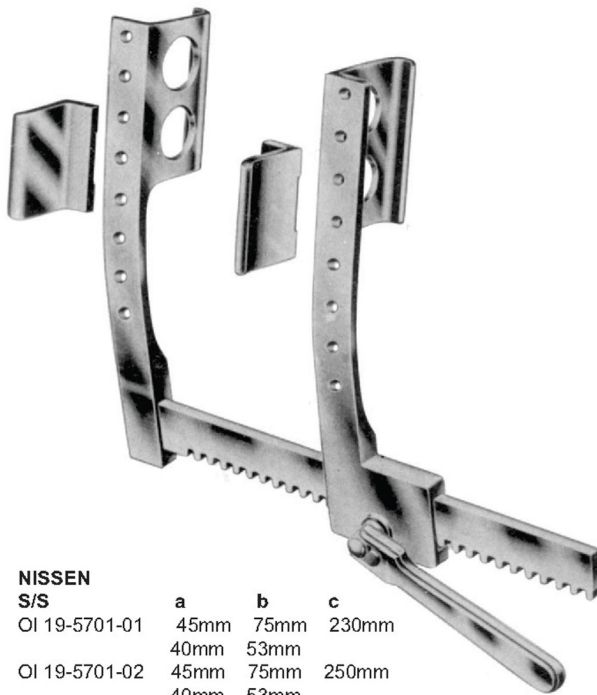

NISSEN	a	b	c
OI 19-5701-01	45mm	75mm	230mm
	40mm	53mm	
OI 19-5701-02	45mm	75mm	250mm
	40mm	53mm	

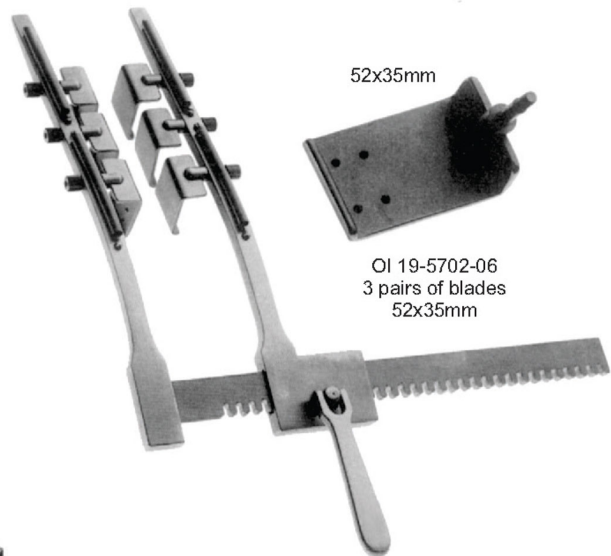

ANKENEY	a	b	c
OI 19-5702-01	52mm	35mm	178mm

52x35mm

OI 19-5702-06
 3 pairs of blades
 52x35mm



- EN — Rib Spreaders
- DE — Rippensperrer
- ES — Separadores costales

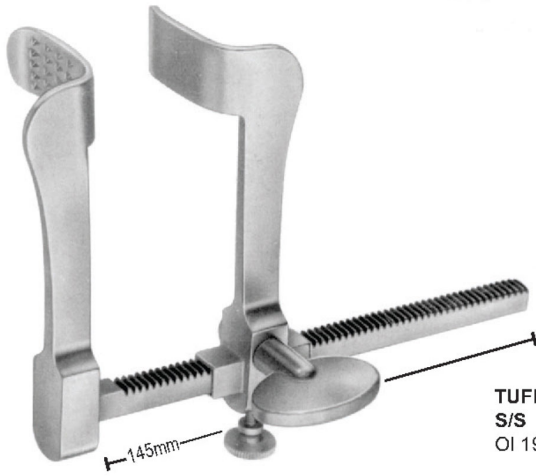

TUFFIER
S/S
OI 19-5703-14

a	b	c
32mm	19mm	110mm

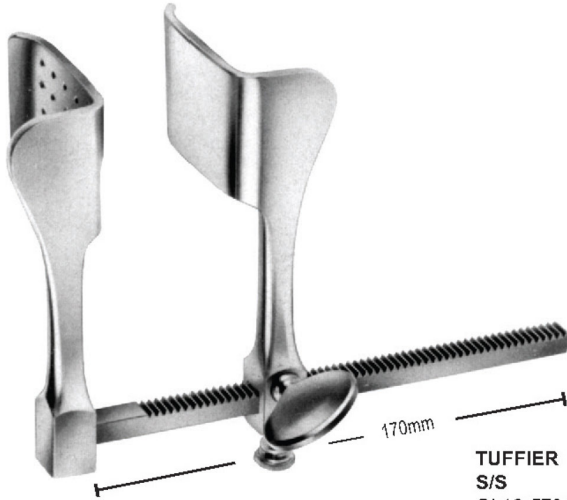

TUFFIER
S/S
OI 19-5704-17

a	b	c
43mm	53mm	130mm

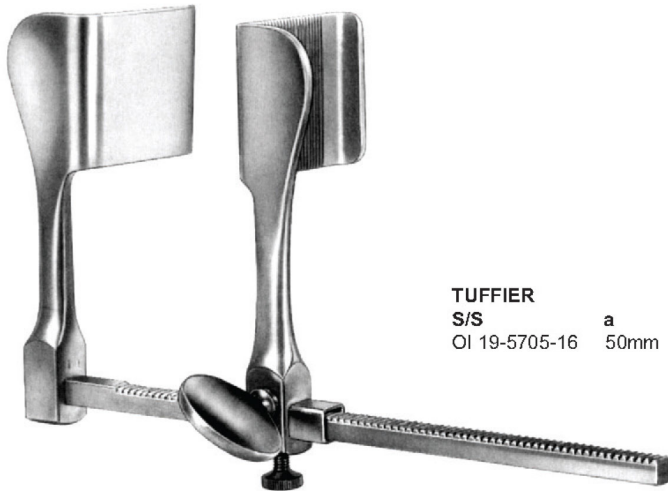

TUFFIER
S/S
OI 19-5705-16

a	b	c
50mm	45mm	165mm



HAIGHT
 S/S
 OI 19-5706-14 a b c
 30mm 30mm 90mm

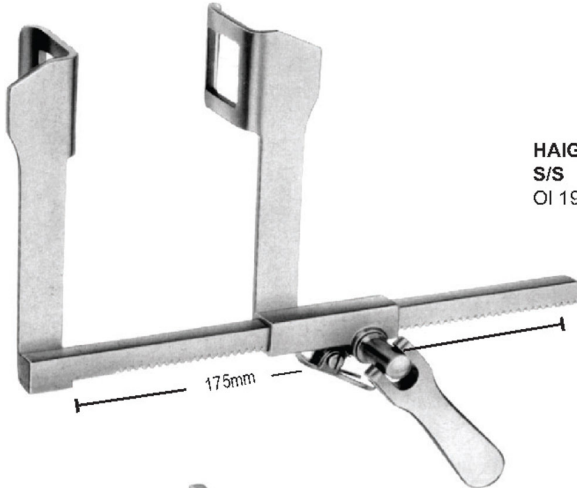

HAIGHT
 S/S
 OI 19-5707-15 a b c
 30mm 30mm 115mm



HERTZLER
 S/S
 OI 19-5708-15 a b c
 20mm 25mm 105mm



- EN — Rib Spreaders
- JE — Rippensperrer
- ES — Separadores costales

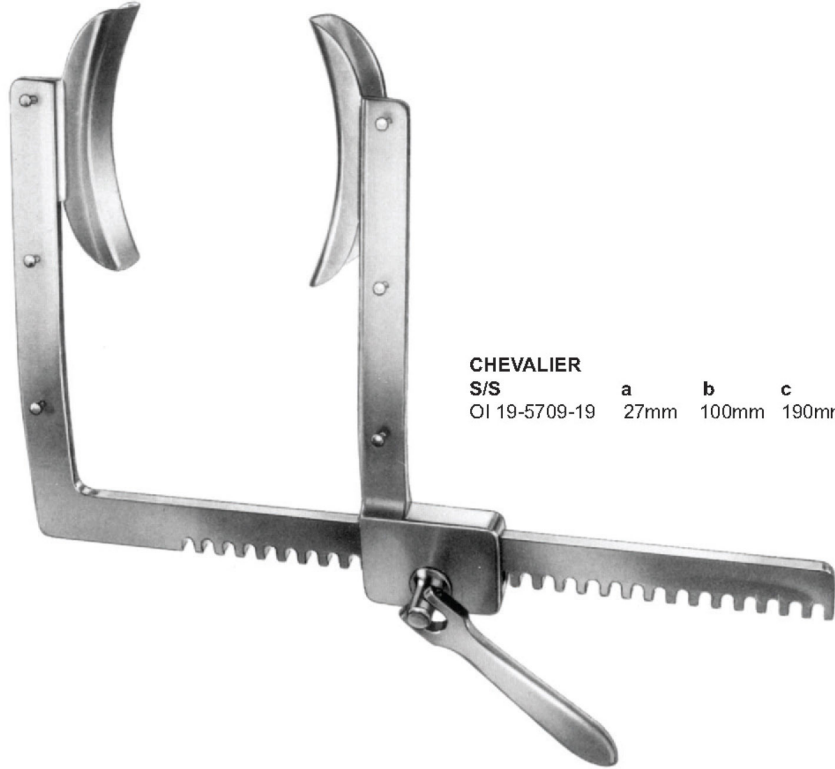

CHEVALIER
S/S
OI 19-5709-19 a b c
 27mm 100mm 190mm

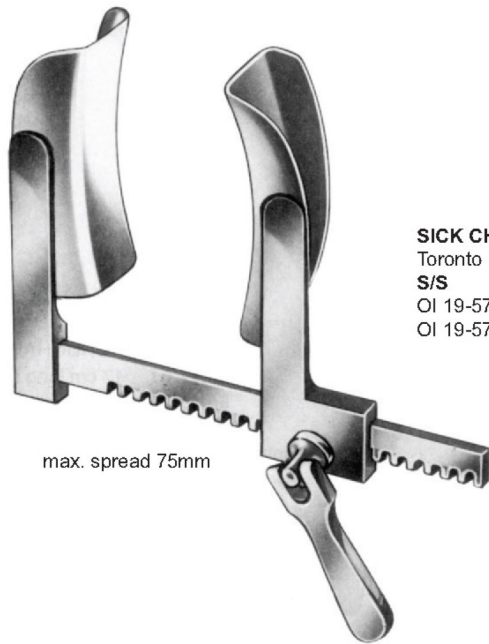

max. spread 75mm

SICK CHILDREN HOSPITAL
Toronto
S/S
OI 19-5710-01 (child) a b c
 20mm 40mm 75mm
OI 19-5710-02 (adult) 20mm 60mm 75mm

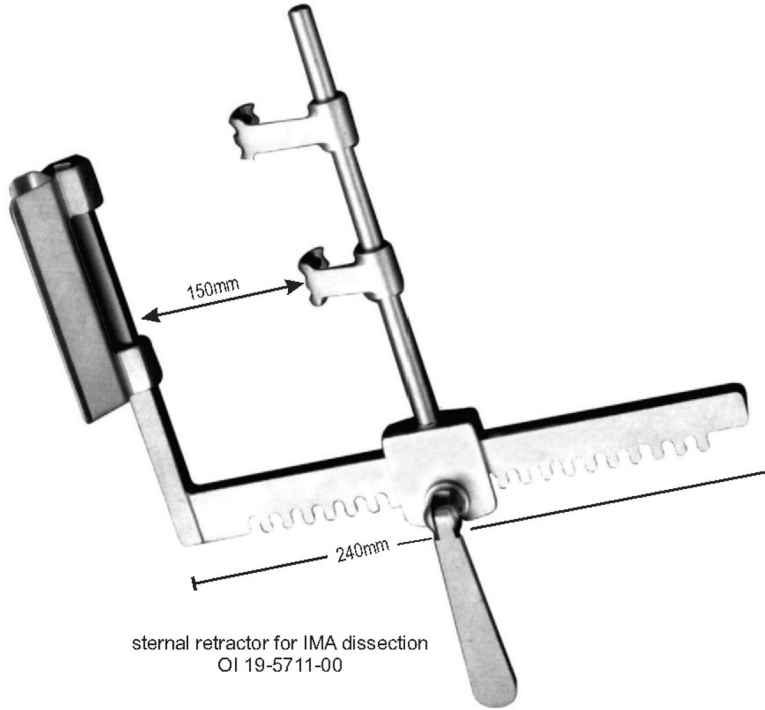

sternal retractor for IMA dissection
OI 19-5711-00



Carpenter's thoracic retractor
(adult)
OI 19-5712-00 complete



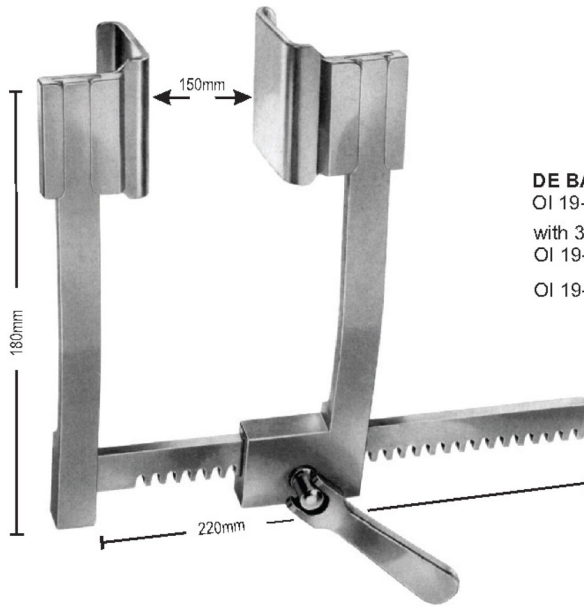

DE BAKEY
 OI 19-5713-00
 with 3 pairs of blades
 OI 19-5713-01
 OI 19-5713-22 spreader only

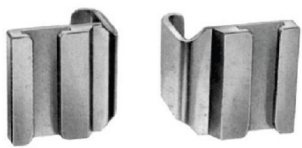

Blades
 OI 19-5713-01
 30 x 30 mm

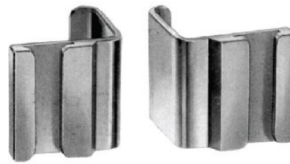

Blades
 OI 19-5713-02
 40 x 40 mm

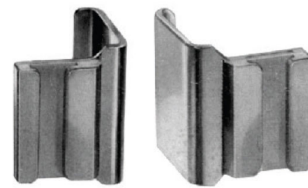

Blades
 OI 19-5713-03
 50 x 50 mm

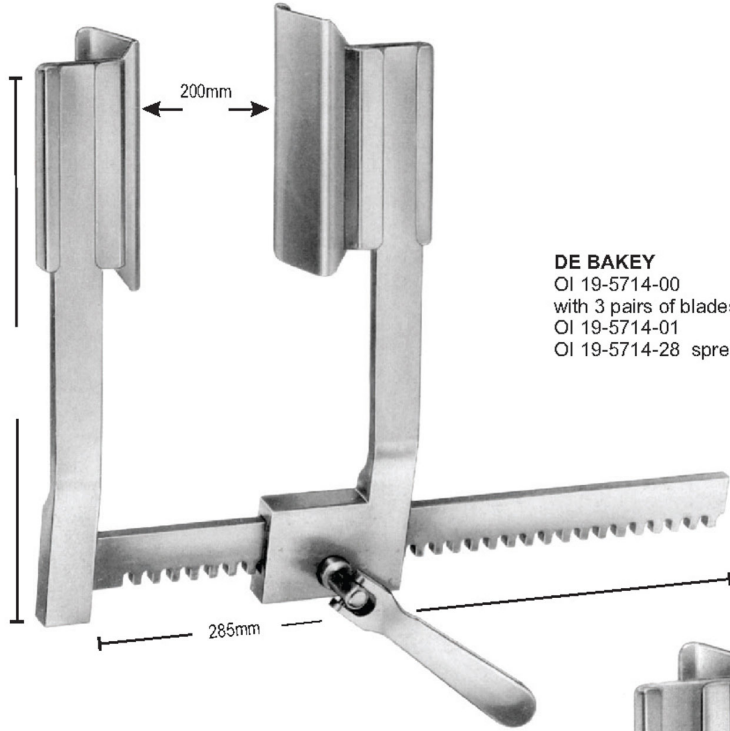

DE BAKEY
 OI 19-5714-00
 with 3 pairs of blades
 OI 19-5714-01
 OI 19-5714-28 spreader only

blades
 OI 19-5714-01
 60 x 60 mm

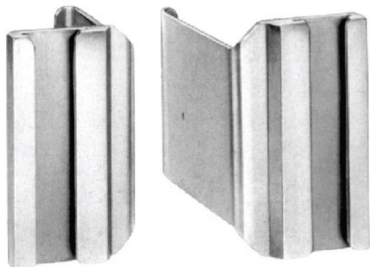

blades
 OI 19-5714-02
 50 x 80 mm

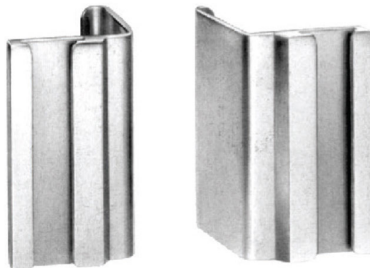

blades
 OI 19-5714-03
 40 x 100 mm

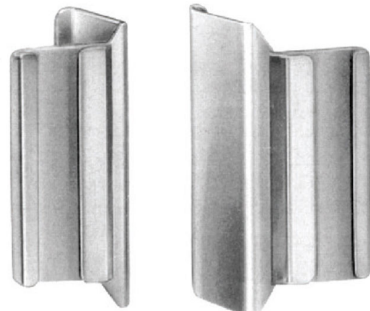

blades
 OI 19-5714-04
 80 x 60 mm

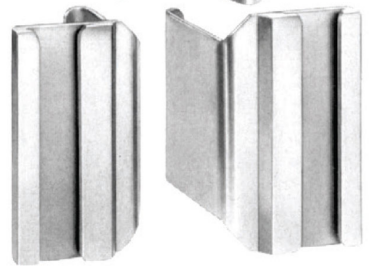

blades
 OI 19-5714-05
 50 x 66 mm



- EN Rib Spreaders
- DE Rippensperrer
- ES Separadores costales

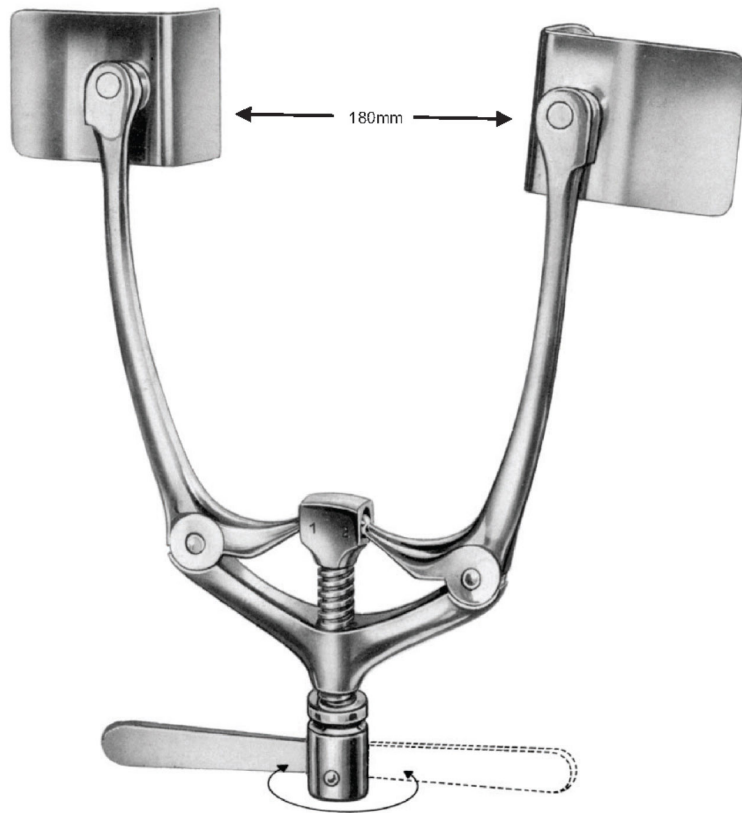

QUERVAIN
OI 19-5715-00
35 X 50 X 180 mm

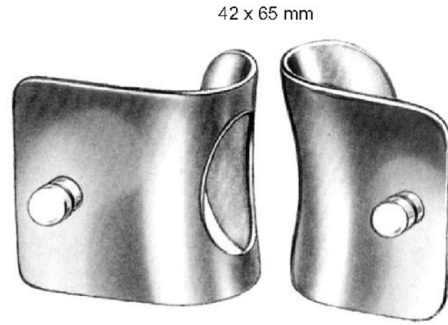

OI 19-5716-65

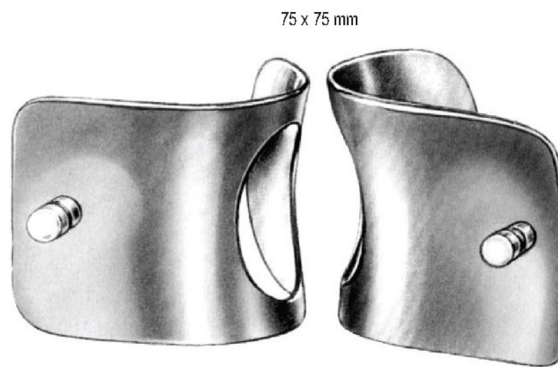

OI 19-5716-75

- OI 19-5716-00 complete consisting of:
- OI 19-5716-01 retractor only
- OI 19-5716-65 1 pair blades 42x65mm
- OI 19-5716-75 1 pair blades 75x75mm



- EN** — Rib Contractors, Lung Spatulas
- DE** — Rippenkontraktoren, Lungenspatel
- ES** — Aproximadores para costillas, Espátula pulmonar



Lemmon
OI 19-5744-18 18 cm/7"
OI 19-5744-14 14 cm/5½"

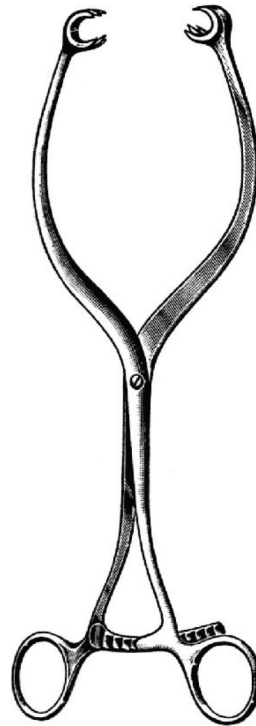

CRAFOORD
OI 19-5744-28
28.0cm

Rib Contractors, Lung Spatulas ● EN
Rippenkontraktoren, Lungenspatel ● DE
Aproximadores para costillas, Espátula pulmonar ● ES



Sellors
OI 19-5745-19
19 cm/7½"



Bailey-Baby
OI 19-5746-14
14 cm/5½"



- EN —● Rib Contractors, Lung Spatulas
- DE —● Rippenkonraktoren, Lungenspatel
- ES —● Aproximadores para costillas, Espátula pulmonar



Bailey
OI 19-5747-16 16 cm/6¼"
OI 19-5747-20 20 cm/8"



Bailey-Gibbon
OI 19-5748-16 16 cm/6¼"
OI 19-5748-20 20 cm/8"



Allison
OI 19-5749-25 25.5 cm/10"
OI 19-5749-30 30.0 cm/12"
OI 19-5749-32 32.0 cm/13"

Lung Spatulas

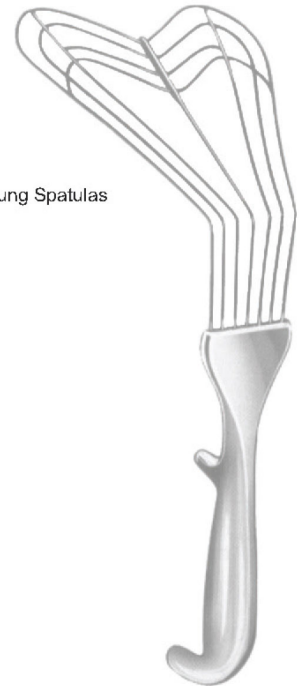

OI 19-5750-30
30 cm/12"



ATRAUMA

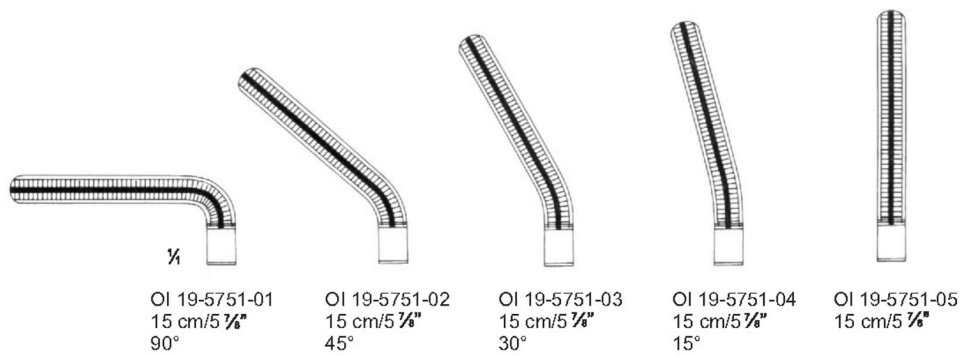

DARDIK

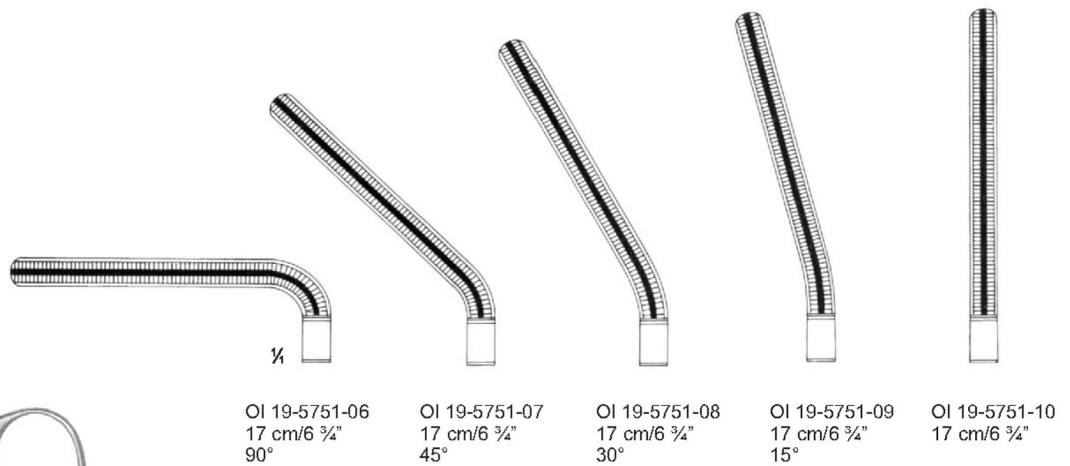



DALE
OI 19-5752-18
18 cm/7 1/8"

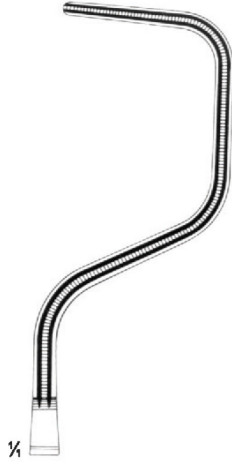

ATRAUMA

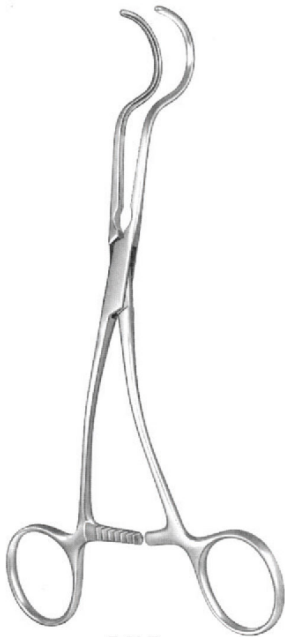

DALE

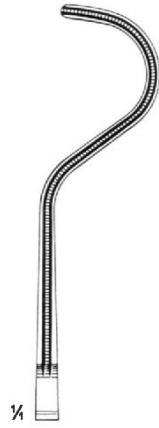

OI 19-5753-17
17.5 cm/6 7/8"



OI 19-5753-18
18 cm/7 1/8"

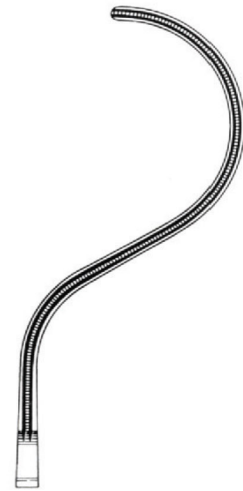

OI 19-5753-19
19 cm/7 1/2"

ATRAUMA



GREGORY

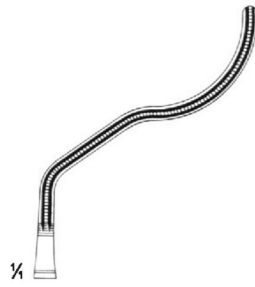

1/4
OI 19-5754-14
14 cm/5 1/2"

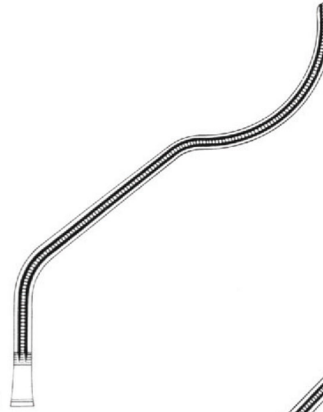

1/4
OI 19-5754-16
16 cm/6 1/4"

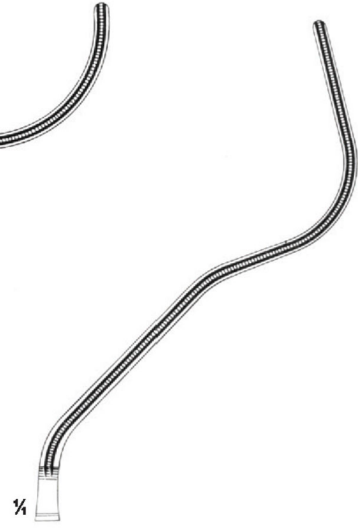

1/4
OI 19-5754-18
18 cm/7 1/8"



- EN —● Carotid Shunt Clamps
- DE —● Carotis-Shuntklemmen
- ES —● Pinzas para shunt carótido

ATRAUMA



JAVID
OI 19-5755-18
18 cm/6 7/8"

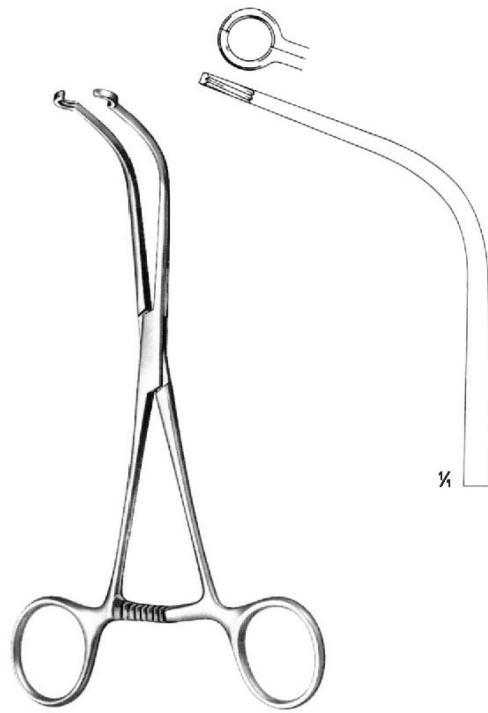

JAVID
OI 19-5756-19
19 cm/7 1/2"



ATRAUMA

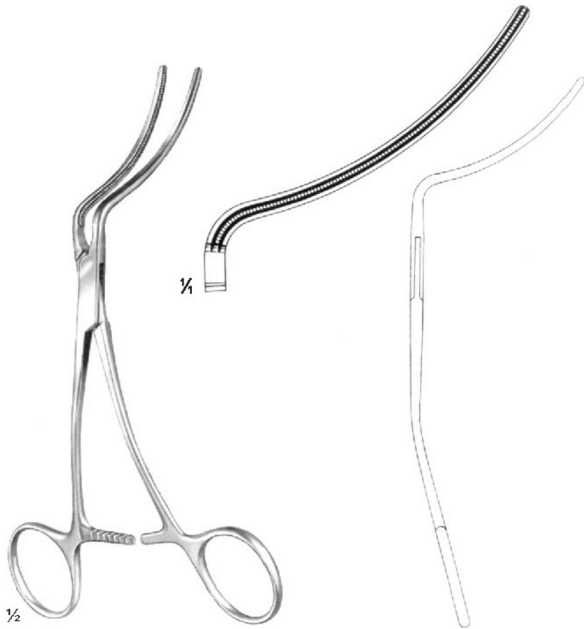

Dardik
 OI 19-5757-16
 16 cm/6 1/4"

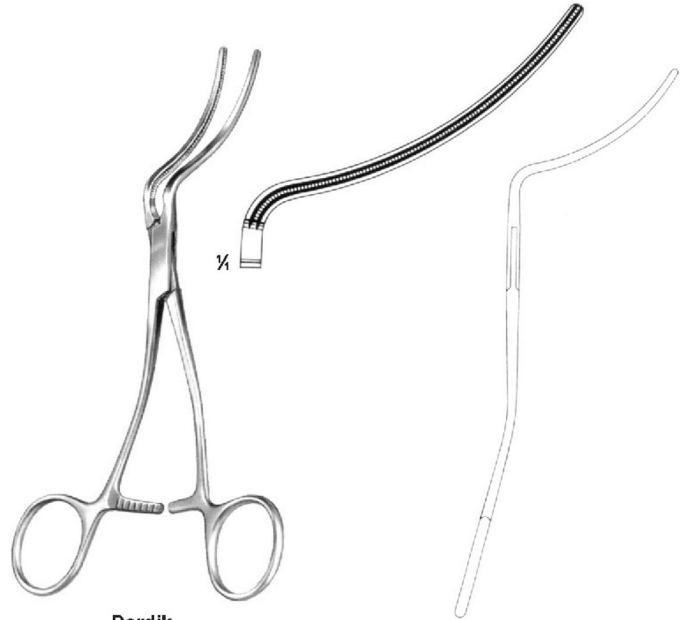

Dardik
 OI 19-5758-17
 17 cm/6 3/4"

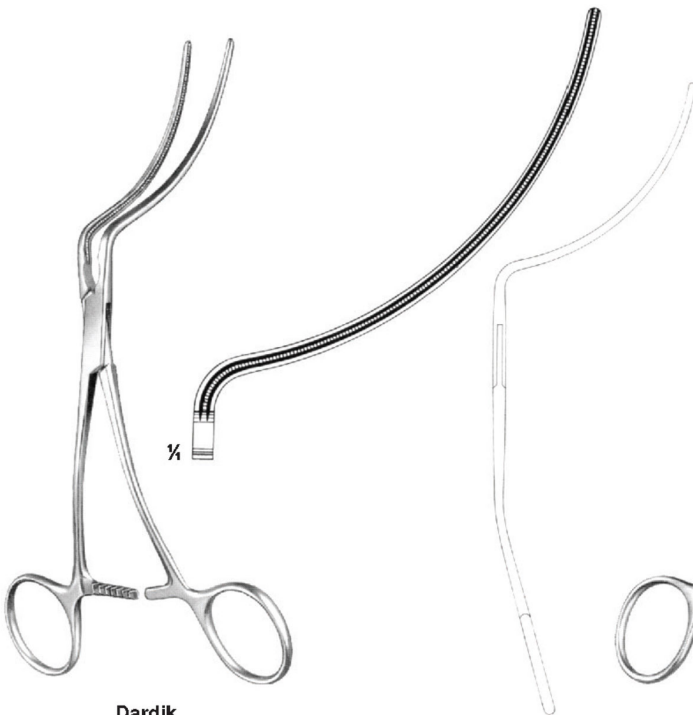

Dardik
 OI 19-5759-18
 18 cm/7 1/8"

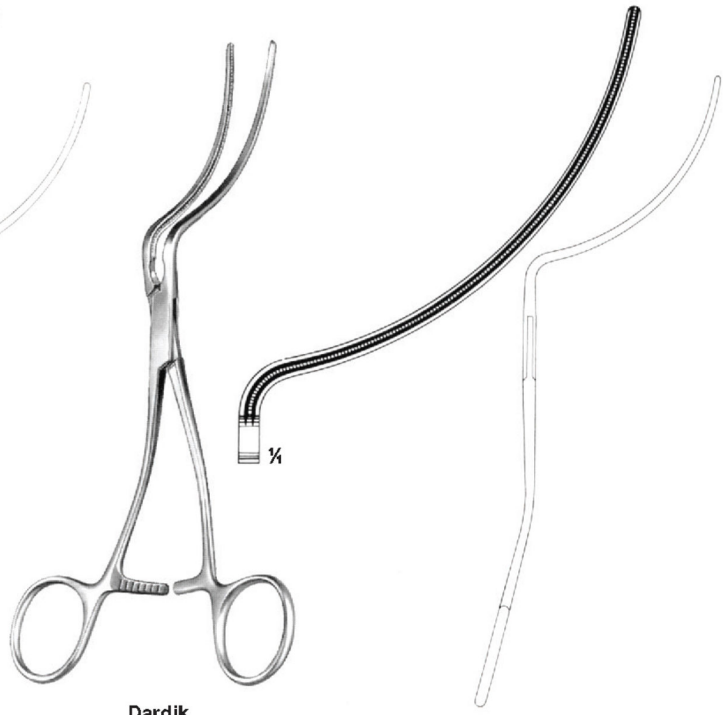

Dardik
 OI 19-5760-19
 19.5 cm/7 3/4"





ATRAUMA

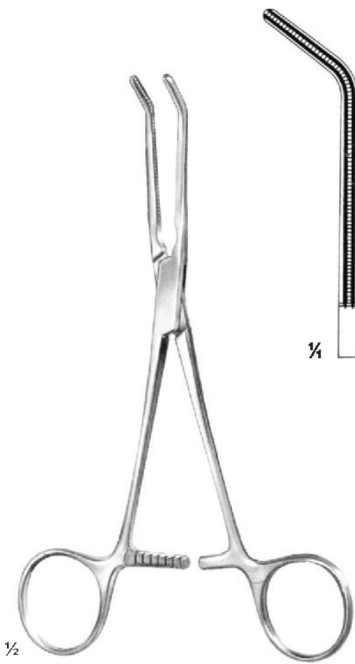

HUSFELDT
 OI 19-5761-17
 17.5 cm/6 7/8"

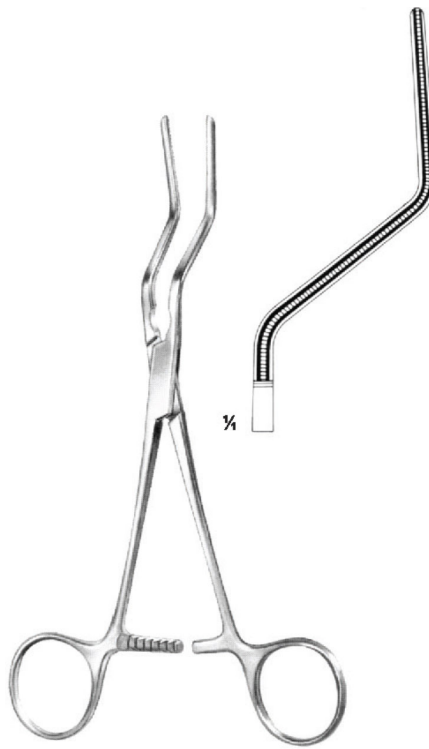

HUSFELDT
 OI 19-5762-18
 18 cm/7 1/8"

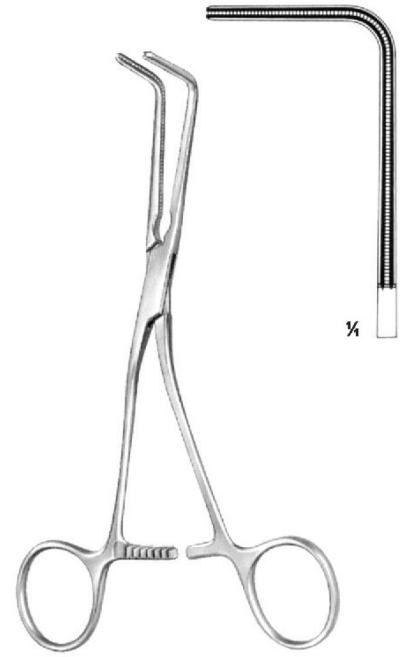

HUSFELDT
 OI 19-5763-17
 17 cm/6 3/4"



OI 19-5764-17
17 cm/6 3/4"
Vascular Measuring Device





ATRAUMA

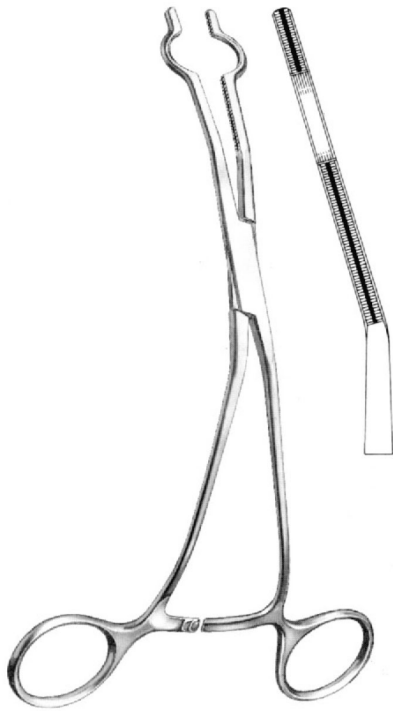

COOLEY



OI 19-5765-01
17 cm/6 3/4"
20 Charr.



OI 19-5765-02
17 cm/6 3/4"
24 Charr.



OI 19-5765-03
17 cm/6 3/4"
26 Charr.



OI 19-5765-04
20 cm/7 1/8"
28 Charr.



OI 19-5765-05
20 cm/7 1/8"
30 Charr.



OI 19-5765-06
20 cm/7 7/8"
32 Charr.



OI 19-5765-07
20 cm/7 7/8"
36 Charr.

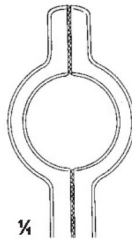

1/4
OI 19-5765-08
20 cm/7 7/8"
38 Charr.



OI 19-5765-09
20 cm/7 7/8"
40 Charr.

ATRAUMA

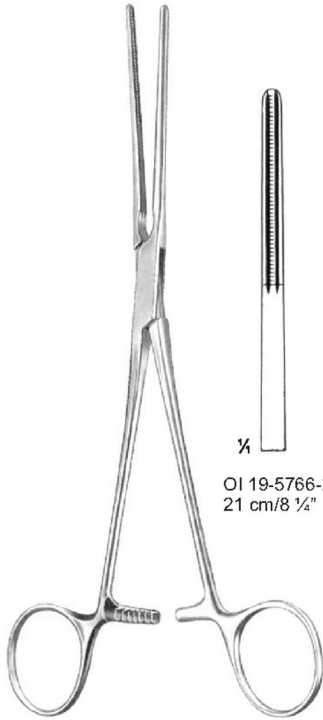

OI 19-5766-21
 21 cm/8 1/4"

POTTS



OI 19-5766-22
 22.5 cm/8 7/8"



OI 19-5767-20
 20.5 cm/8 1/4"

POTTS



OI 19-5767-22
 22 cm/8 3/4"

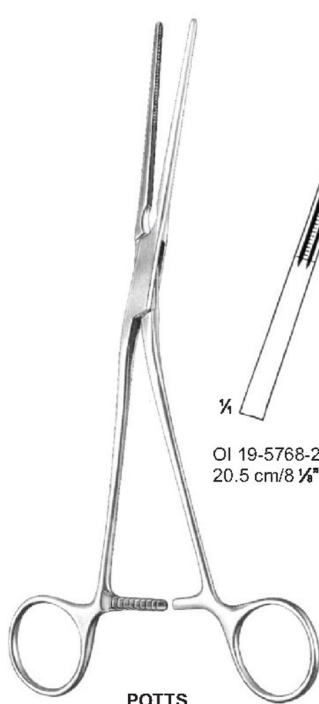

OI 19-5768-20
 20.5 cm/8 1/4"

POTTS



OI 19-5768-22
 22 cm/8 3/4"



- EN** —●— Anastomosis Clamps, Ligature Forceps
- DE** —●— Anastomosenklemmen, Ligaturklemmen
- ES** —●— Pinzas para anastomosis, Pinzas para ligaduras

ATRAUMA



POTTS-GLOVER
OI 19-5769-21
21.5 cm/8 1/2"

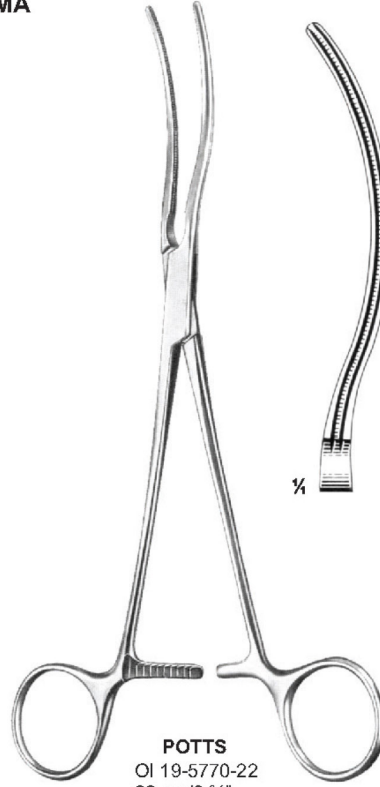

POTTS
OI 19-5770-22
22 cm/8 3/4"

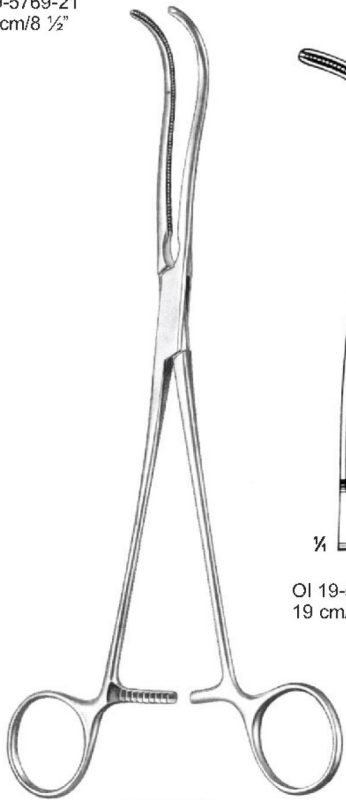

DEBAKEY
Dissecting and Ligature Forceps



OI 19-5771-19
19 cm/7 1/2"



OI 19-5771-24
24 cm/9 1/2"



ATRAUMA



DEBAKEY
 OI 19-5772-16
 16 cm/6 1/4"

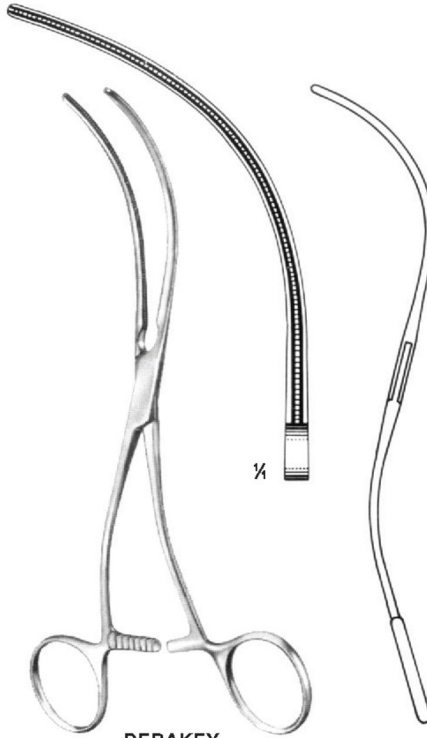

DEBAKEY
 OI 19-5773-19
 19 cm/7 1/2"



DEBAKEY
 OI 19-5774-20
 20 cm/8"

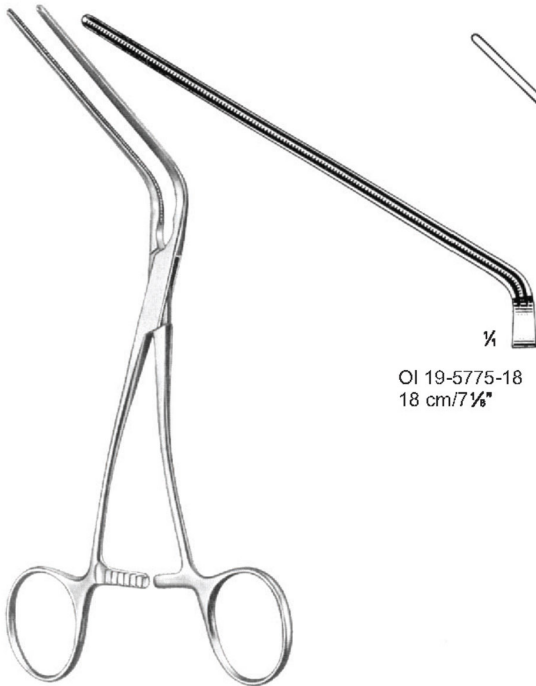

LELAND-JONES

OI 19-5775-18
 18 cm/7 1/8"

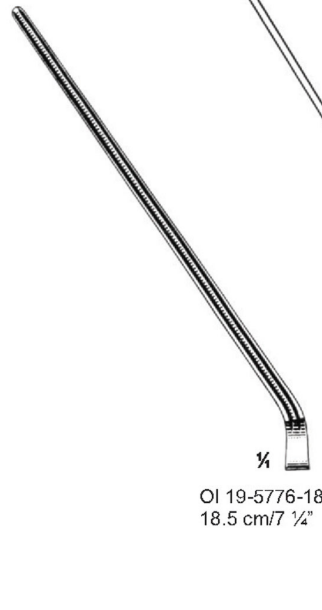

OI 19-5776-18
 18.5 cm/7 1/4"

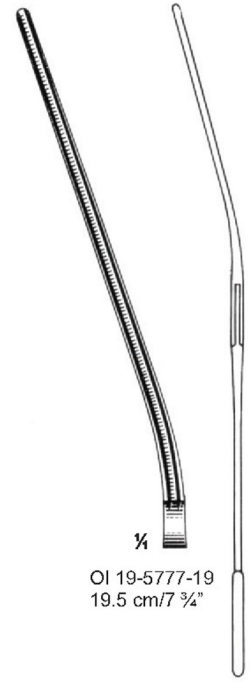

OI 19-5777-19
 19.5 cm/7 3/4"



ATRAUMA

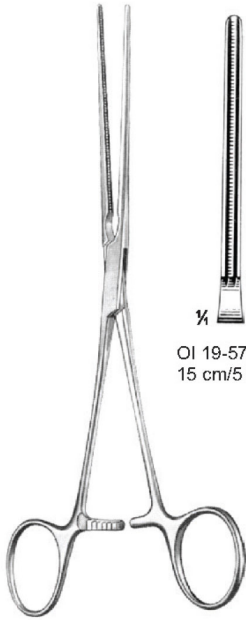

1/4
 OI 19-5778-15
 15 cm/5 1/4"

BAINBRIDGE



1/4
 OI 19-5778-18
 18.5 cm/7 1/4"



BAINBRIDGE



1/4
 OI 19-5779-15
 15 cm/5 1/4"



1/4
 OI 19-5779-18
 18.5 cm/7 1/4"



DEBAKEY
 OI 19-5780-20
 20 cm/7 1/4"

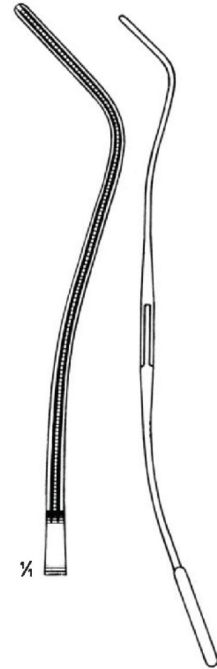

1/4



ATRAUMA



DEBAKEY



OI 19-5781-26
26 cm/10 1/4"

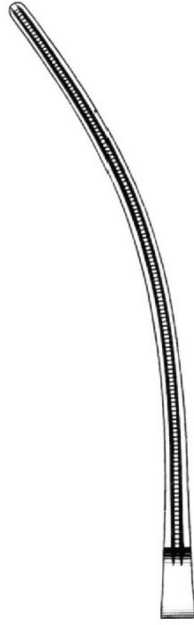

OI 19-5782-27
27 cm/10 1/2"

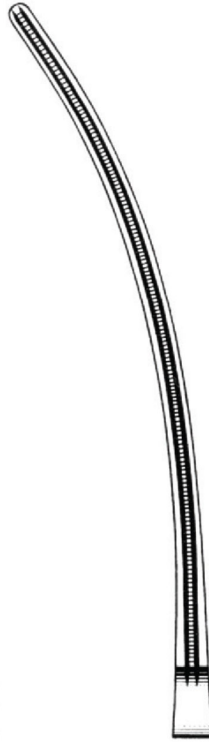

OI 19-5783-31
31 cm/12 1/4"

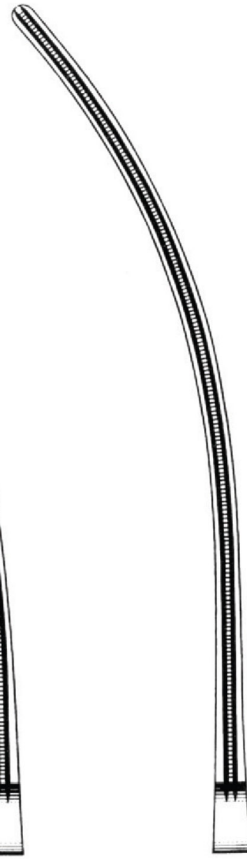

OI 19-5784-33
33 cm/13"





ATRAUMA



DEBAKEY
 OI 19-5785-28
 28 cm/11"

DEBAKEY
 OI 19-5786-30
 30 cm/11 3/4"

ATRAUMA



DEBAKEY
 OI 19-5787-27
 27 cm/10 1/2"

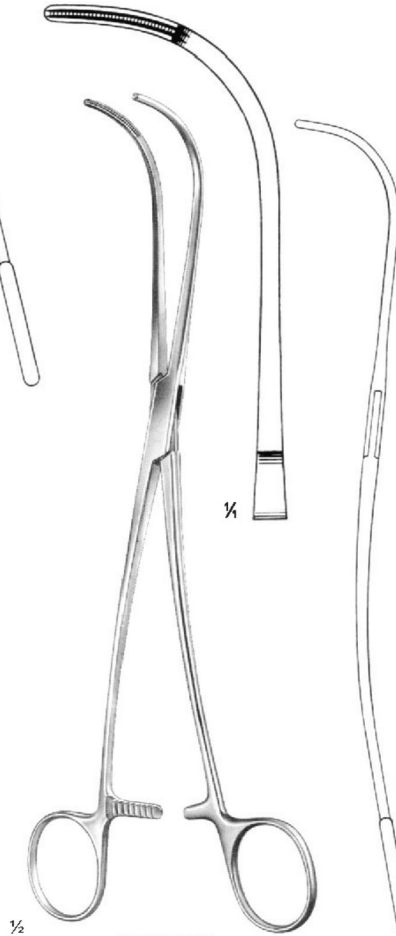
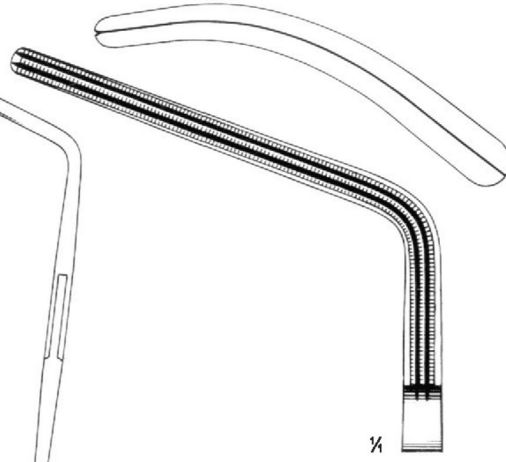

DEBAKEY
 OI 19-5788-24
 24.5 cm/9 3/4"

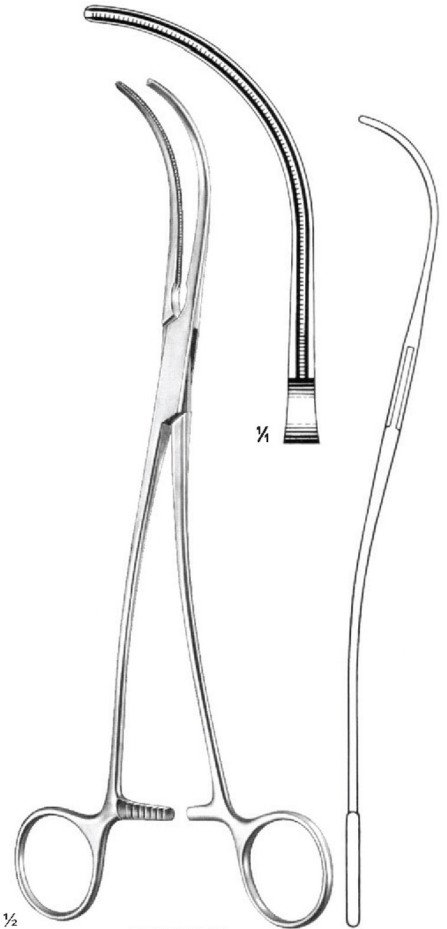

DEBAKEY
 OI 19-5789-24
 24.5 cm/9 3/4"



ATRAUMA

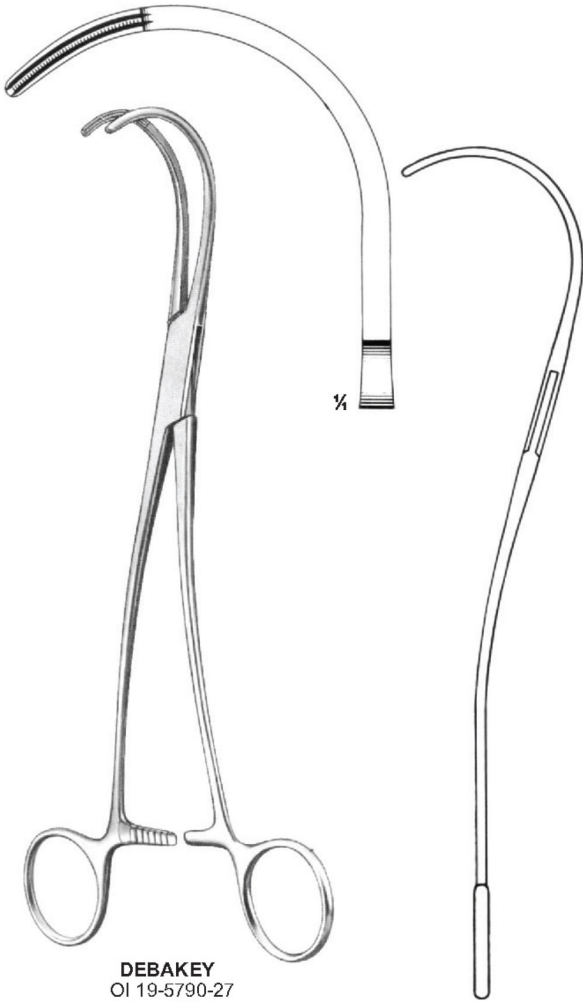

DEBAKEY
 OI 19-5790-27
 27 cm/10 1/2"



DEBAKEY
 OI 19-5791-27
 27 cm/10 1/2"

ATRAUMA

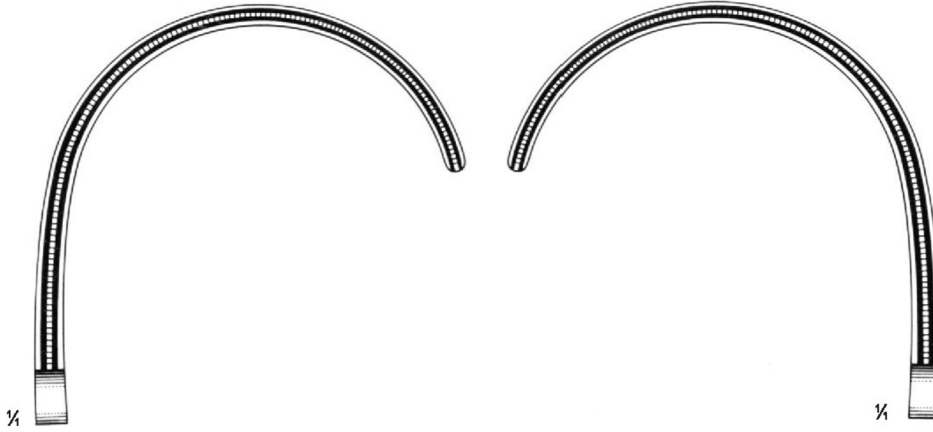

WEBER
OI 19-5792-24
24 cm/9 1/2"



WEBER
OI 19-5793-24
24 cm/9 1/2"



ATRAUMA

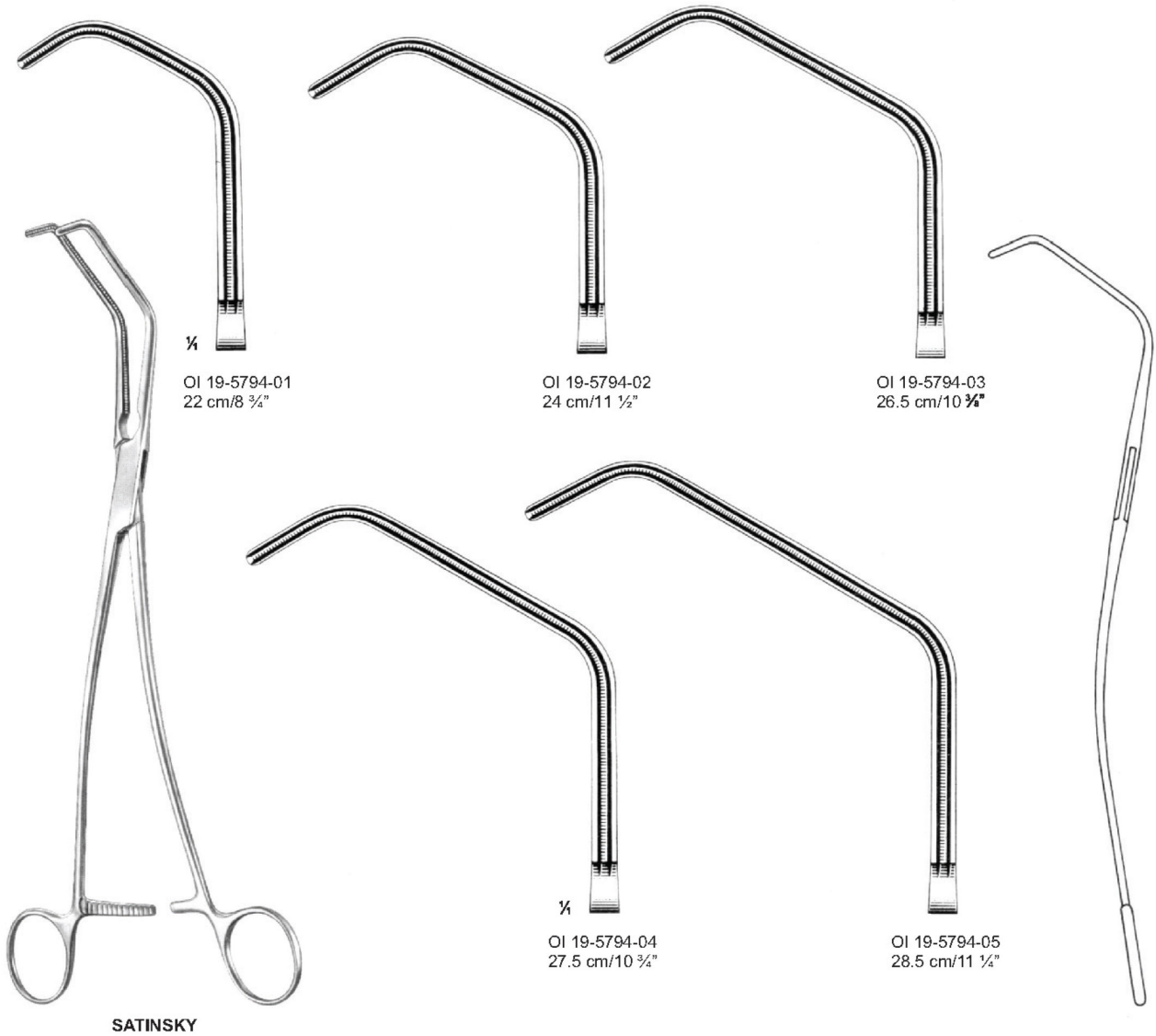

SATINSKY

ATRAUMA



HARKEN



OI 19-5795-01
 24.5 cm/9 3/4"



OI 19-5795-02
 24 cm/9 1/2"

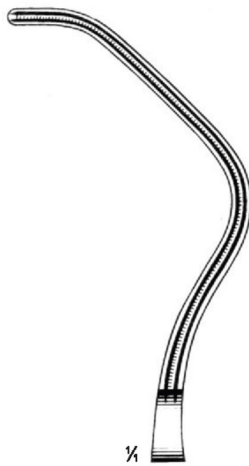

OI 19-5795-03
 23 cm/9"



OI 19-5795-04
 23.5 cm/9 1/4"



ATRAUMA

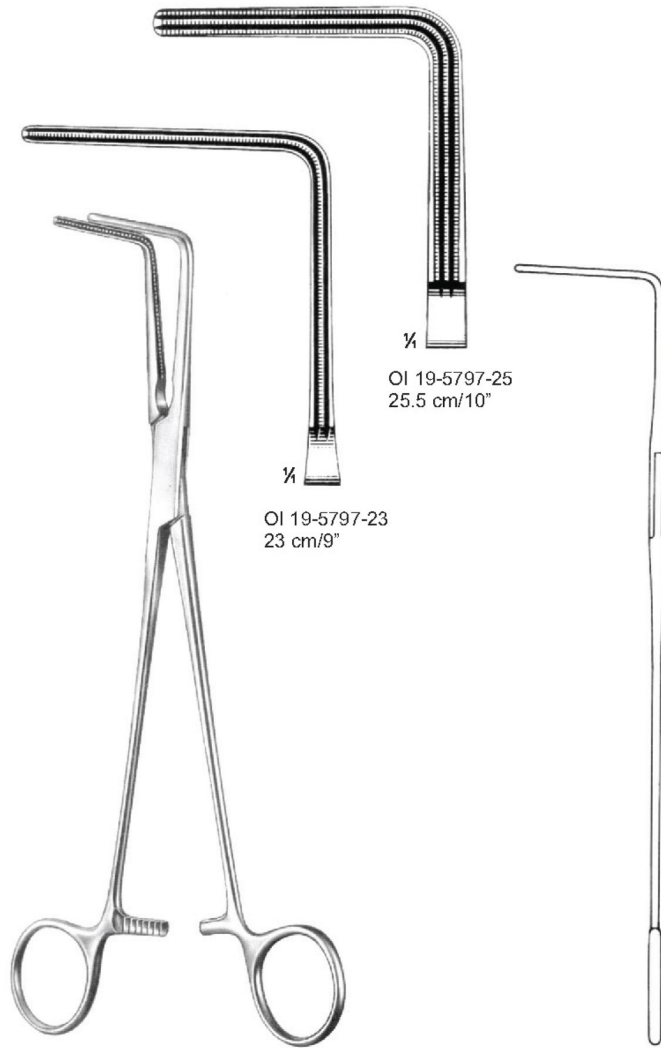

LEES

ATRAUMA

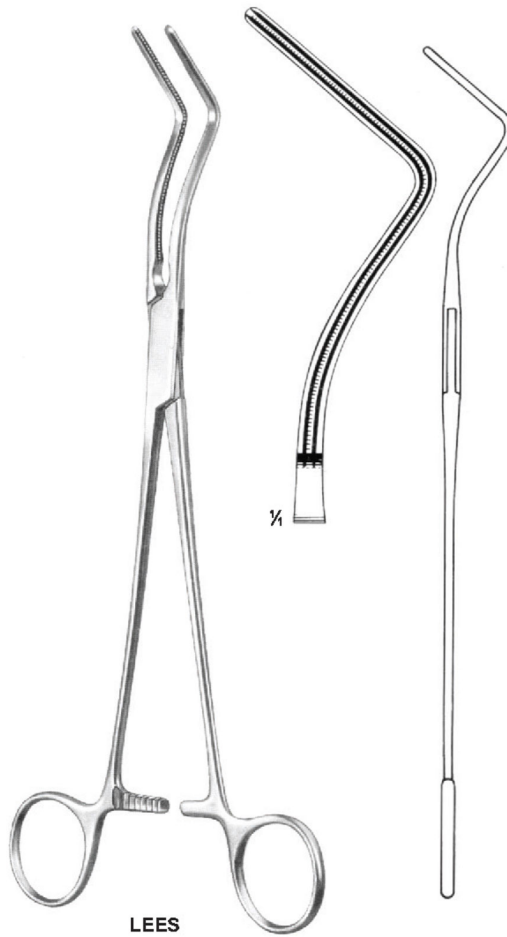

LEES
OI 19-5798-25
25 cm/9 1/4"



ATRAUMA



LAMBERT-KAY

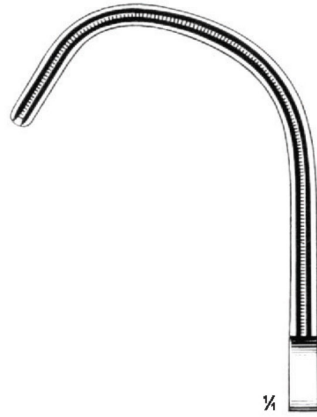

OI 19-5799-01
22.5 cm/8 3/4"

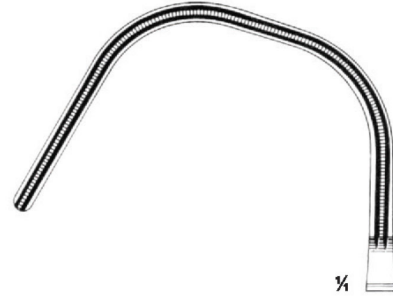

OI 19-5799-02
22.5 cm/8 3/4"

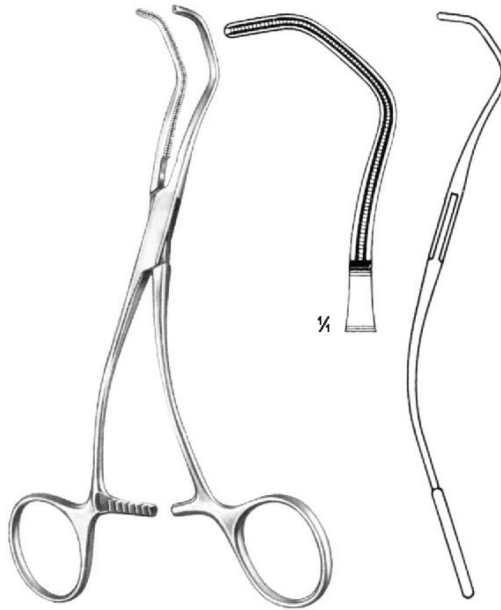
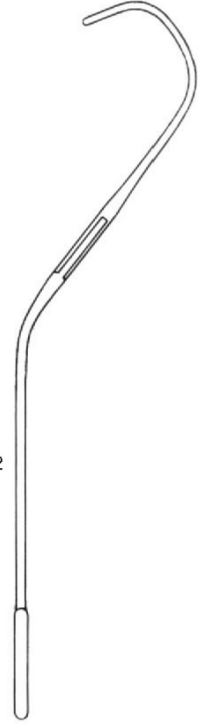

DEBAKEY
OI 19-5800-16
16.5 cm/6 1/2"



ATRAUMA

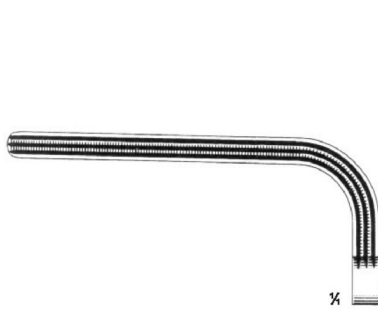

OI 19-5801-18
18.5 cm/7 1/4"

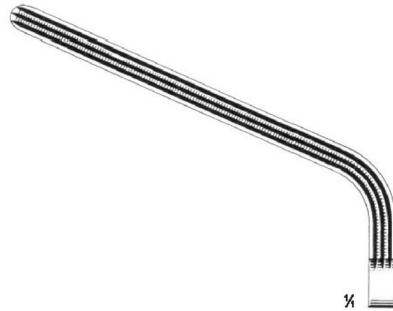

OI 19-5801-20
20 cm/7 3/4"

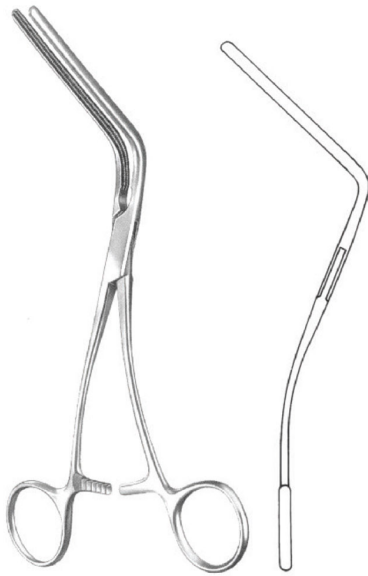

MORRIS-DEBAKEY

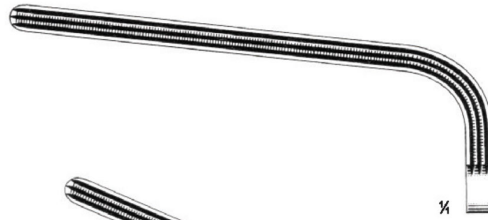

OI 19-5801-26
26 cm/10 1/4"

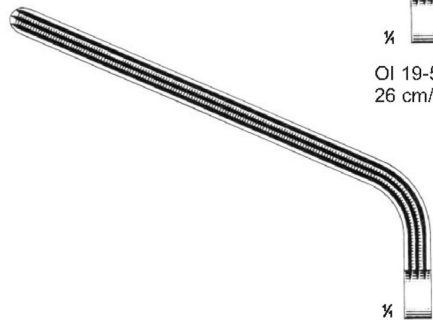

OI 19-5801-27
27.5 cm/10 3/4"





ATRAUMA



DEBAKEY-BAHNSON

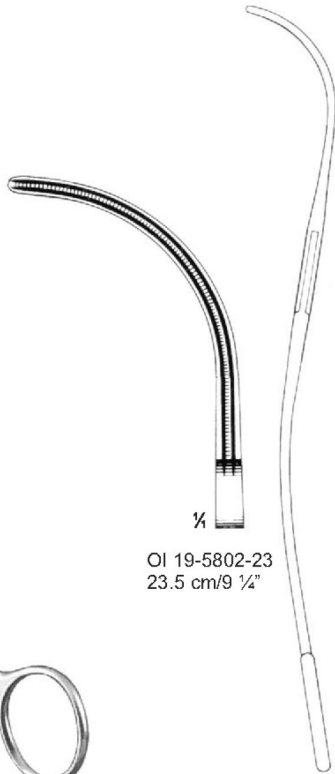

OI 19-5802-23
23.5 cm/9 1/4"

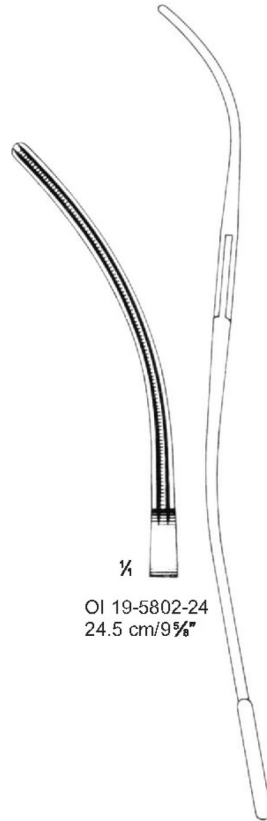

OI 19-5802-24
24.5 cm/9 5/8"

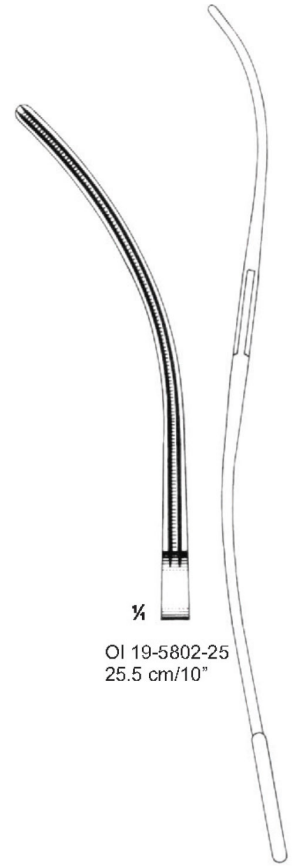

OI 19-5802-25
25.5 cm/10"

- EN
- DE
- ES

ATRAUMA



POTTS



¼

OI 19-5803-21
 21.5 cm/8 ½"



OI 19-5803-23
 23.5 cm/9 ¼"



OI 19-5803-27
 27 cm/10 ½"



OI 19-5803-31
 31.5 cm/12 ¾"



POTTS



¼

OI 19-5804-21
 21 cm/8 ¼"



OI 19-5804-23
 23 cm/9"



OI 19-5804-26
 26 cm/10 ¼"



OI 19-5804-31
 31 cm/12 ¼"



ATRAUMA



DEBAKEY



DEBAKEY

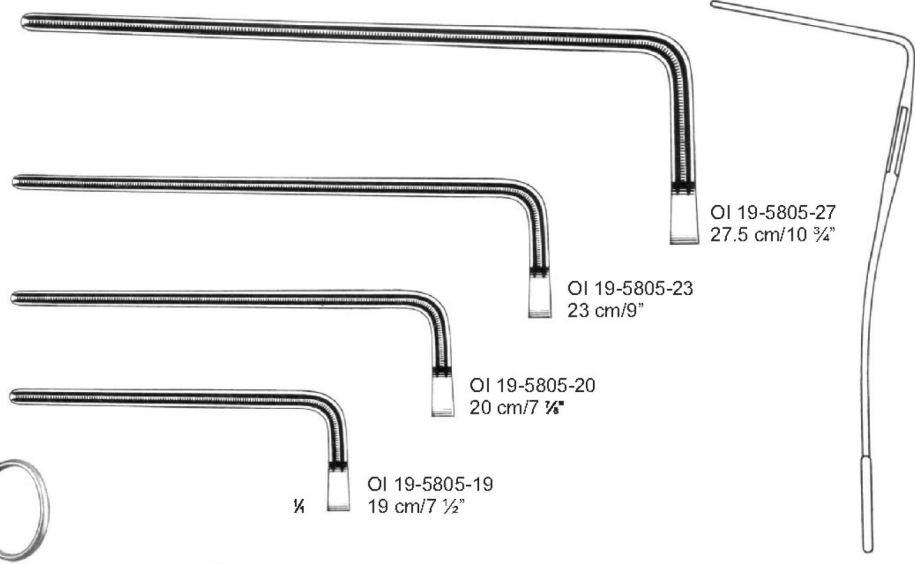

OI 19-5805-27
27.5 cm/10 3/4"

OI 19-5805-23
23 cm/9"

OI 19-5805-20
20 cm/7 1/4"

1/4 OI 19-5805-19
19 cm/7 1/2"

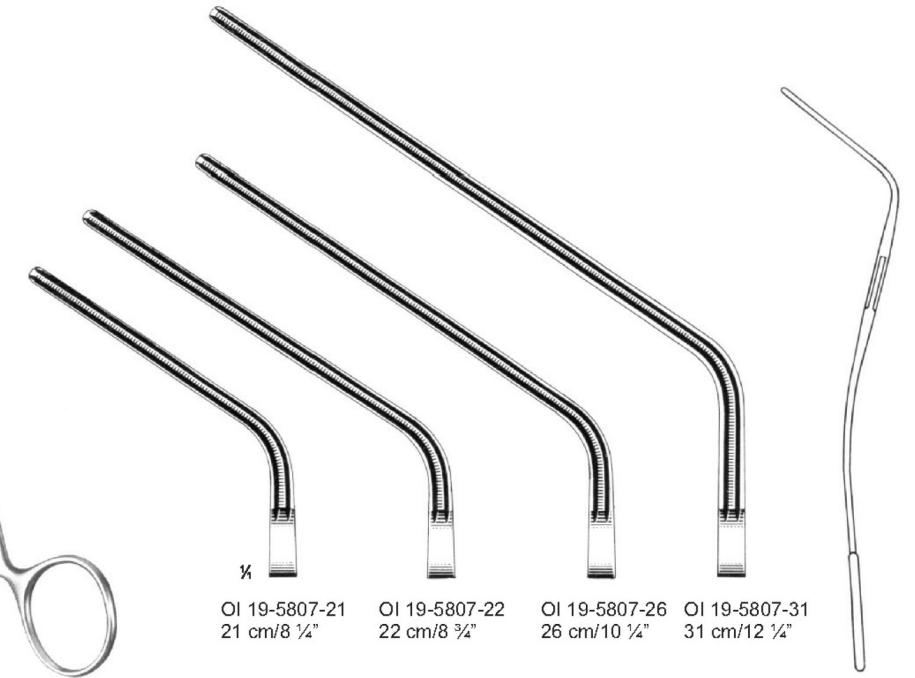

1/4 OI 19-5807-21
21 cm/8 1/4"

OI 19-5807-22
22 cm/8 3/4"

OI 19-5807-26
26 cm/10 1/4"

OI 19-5807-31
31 cm/12 1/4"



ATRAUMA

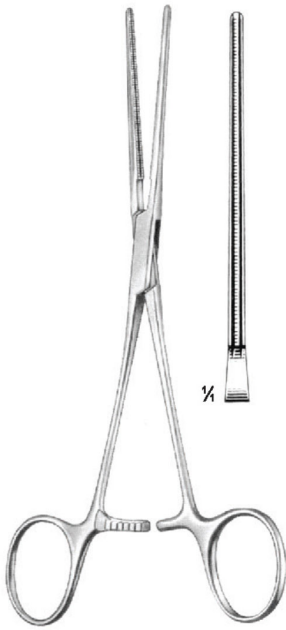

DEBAKEY
 OI 19-5808-17
 17 cm/6 3/4"

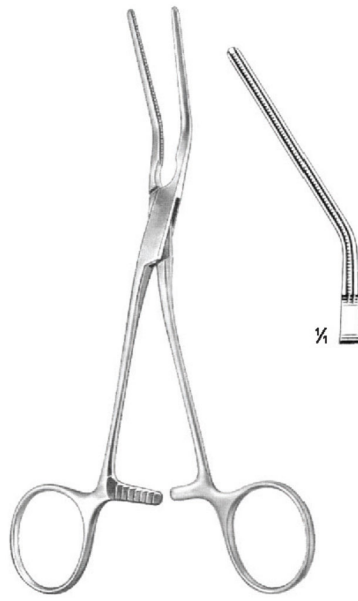

DEBAKEY
 OI 19-5809-16
 16.5 cm/6 1/2"

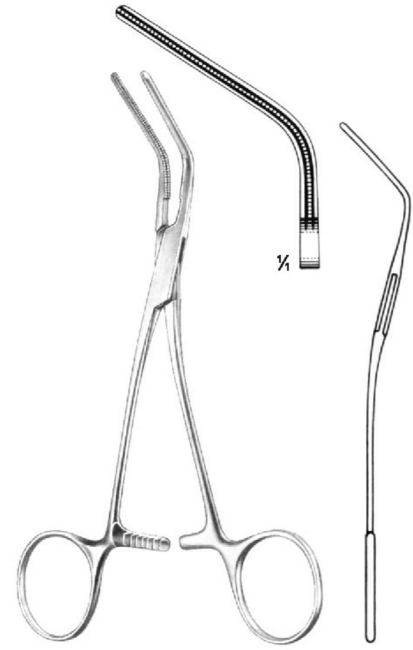

DEBAKEY
 OI 19-5810-16
 16 cm/6 1/4"



DEBAKEY
 OI 19-5811-14
 14.5 cm/5 3/4"



DEBAKEY
 OI 19-5812-16
 16.5 cm/6 1/2"



ATRAUMA

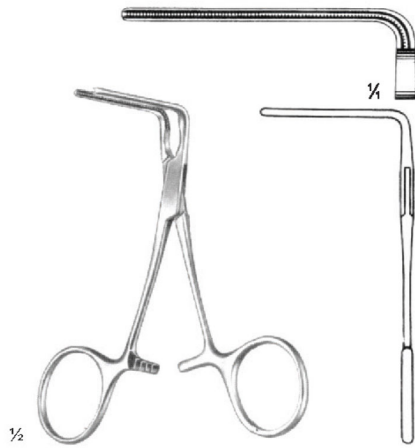

DEBAKEY
 OI 19-5813-10
 10 cm/3 3/4"

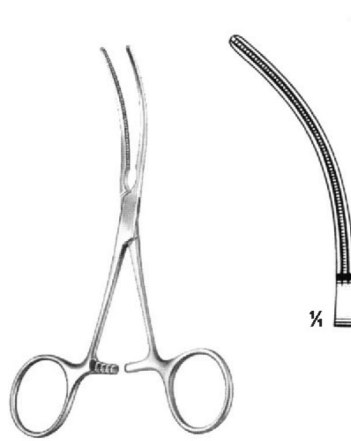

DEBAKEY
 OI 19-5814-12
 12.5 cm/4 1/4"

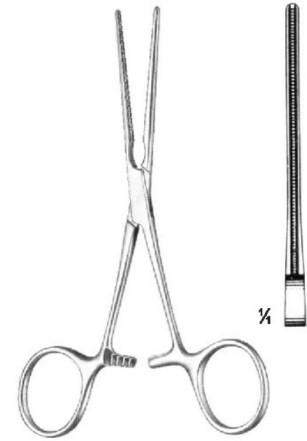

DEBAKEY
 OI 19-5815-13
 13 cm/5 1/8"

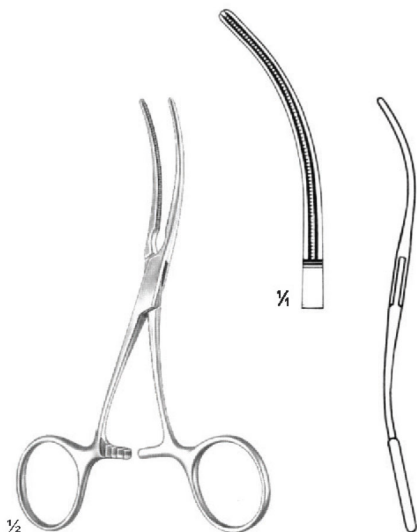

DEBAKEY
 OI 19-5816-12
 12.5 cm/4 3/8"

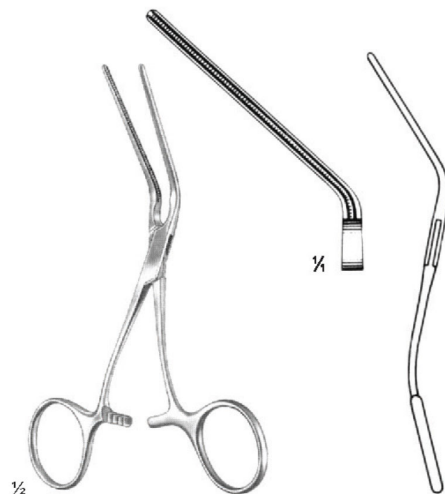

DEBAKEY
 OI 19-5817-12
 12.5 cm/4 3/8"



ATRAUMA

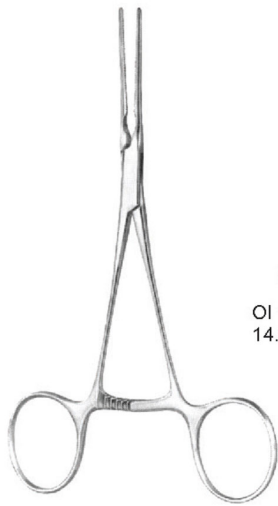

¼
 OI 19-5818-14
 14.5 cm/5 ¾"

COOLEY



¼
 OI 19-5819-14
 14.5 cm/5 ¾"

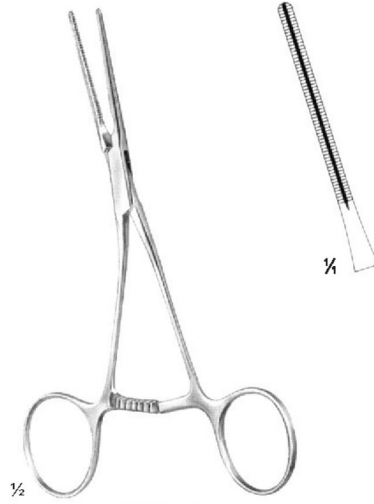

½
 COOLEY
 OI 19-5820-14
 14 cm/5 ½"



½
 COOLEY
 OI 19-5821-14
 14 cm/5 ½"



¼



COOLEY
 OI 19-5822-14
 14.5 cm/5 ¾"



¼



ATRAUMA

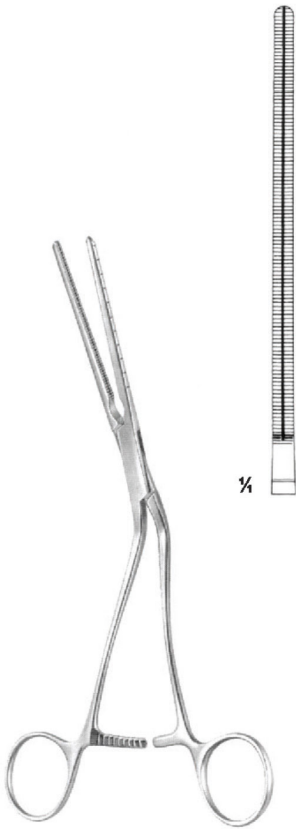

COOLEY
OI 19-5823-22 22 cm/8 3/4"
OI 19-5823-25 25 cm/12"
Liac Clamp

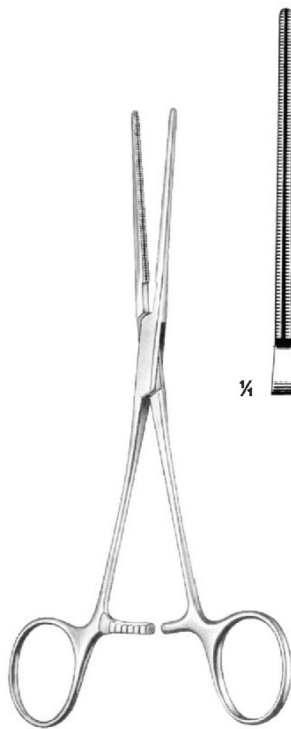

COOLEY
OI 19-5824-17
17 cm/6 3/4"

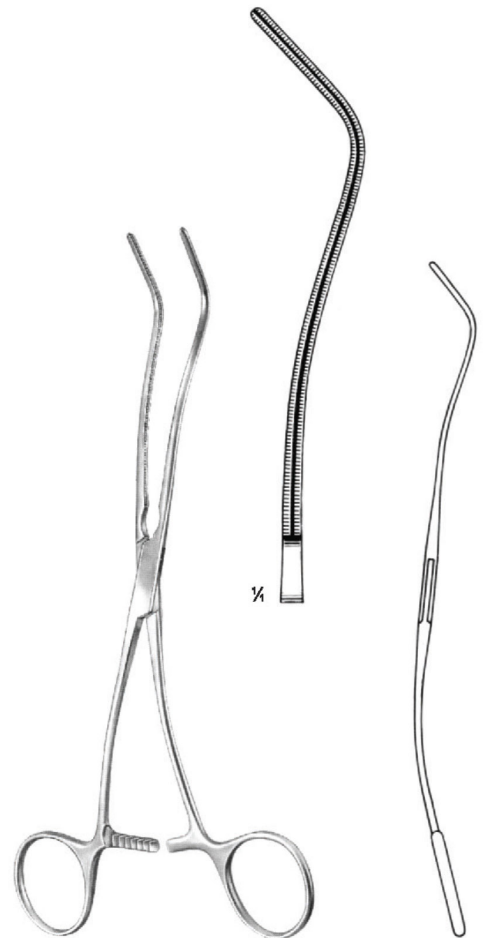

COOLEY
OI 19-5825-20
20 cm/7 7/8"
Carotid Clamps

ATRAUMA

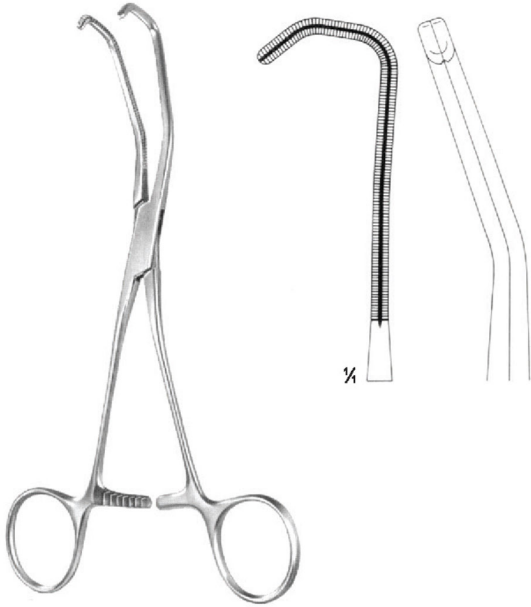

COOLEY
 OI 19-5826-17
 17 cm/6 3/4"



COOLEY
 OI 19-5827-16
 16 cm/6 1/4"

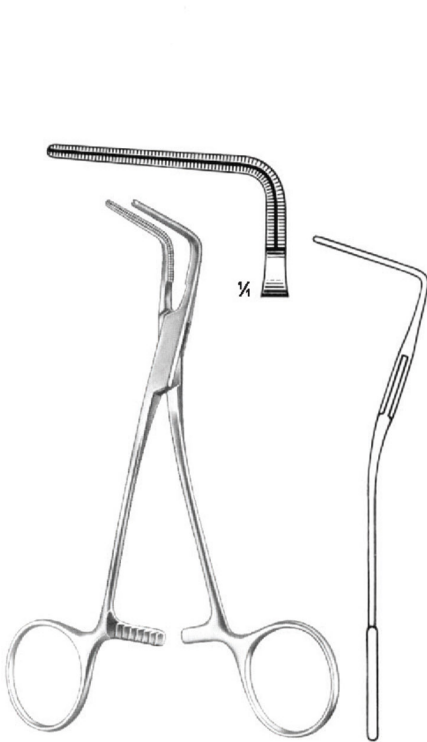

COOLEY
 OI 19-5828-14
 14 cm/5 1/2"



COOLEY
 OI 19-5829-16
 16 cm/6 1/4"

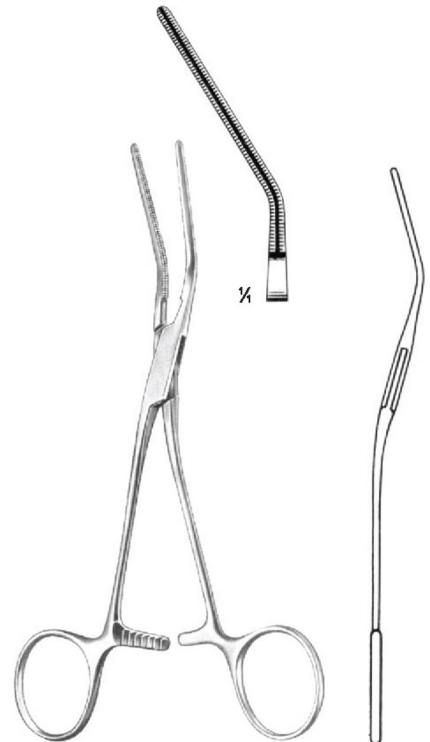

COOLEY
 OI 19-5830-16
 16.5 cm/6 1/2"



ATRAUMA



COOLEY
 OI 19-5831-17
 17 cm/6 3/4"

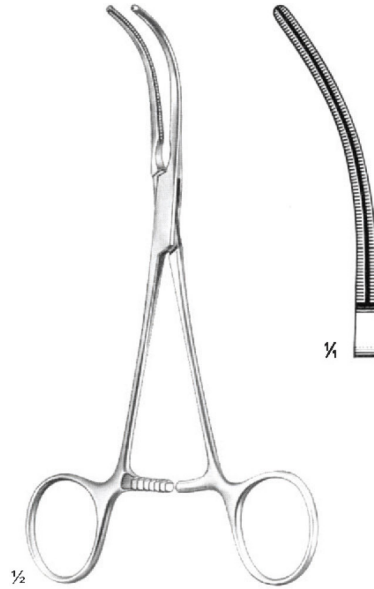

COOLEY
 OI 19-5832-17
 17 cm/6 3/4"

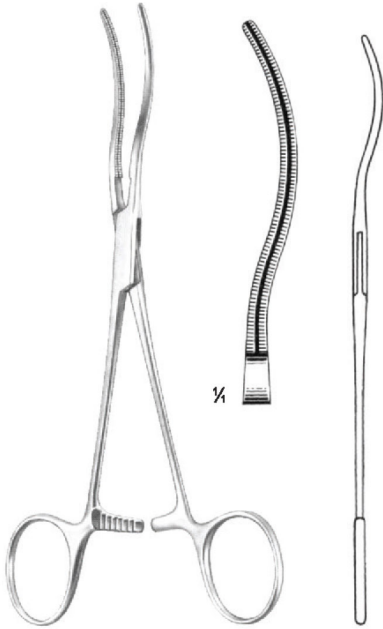

COOLEY
 OI 19-5833-17
 17.5 cm/6 7/8"

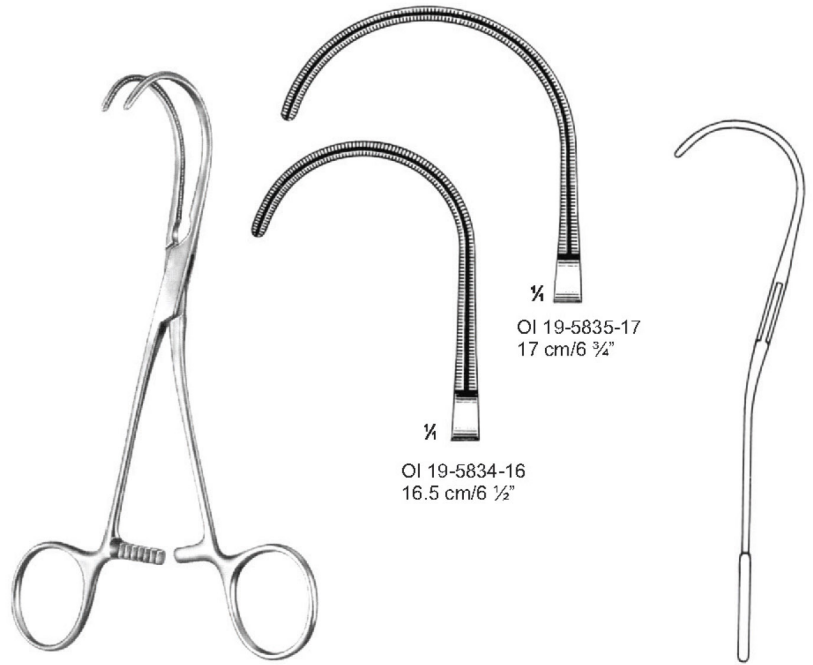

COOLEY
 OI 19-5834-16
 16.5 cm/6 1/2"

OI 19-5835-17
 17 cm/6 3/4"



ATRAUMA



COOLEY-DERRA

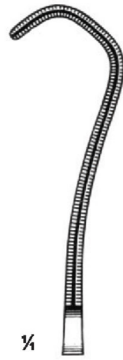

OI 19-5836-16
 16.5 cm/6 1/2"



OI 19-5837-17
 17 cm/6 3/4"



OI 19-5838-18
 17.5 cm/6 3/4"



COOLEY-BECK
 OI 19-5839-17
 17 cm/6 3/4"

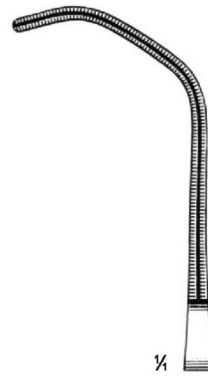

ATRAUMA

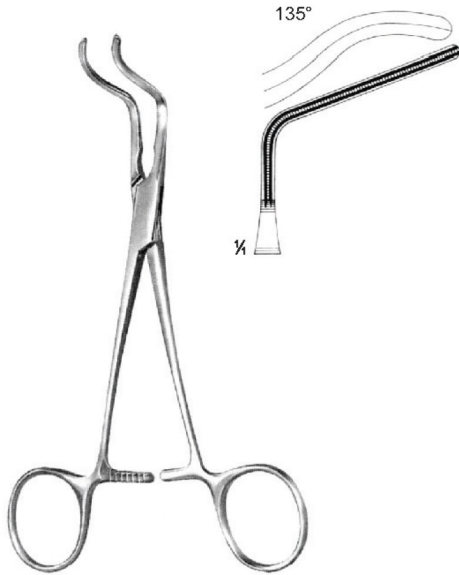

SUBRAMANIAN-MINIATURE
OI 19-5840-15
15.5 cm/6 1/8"

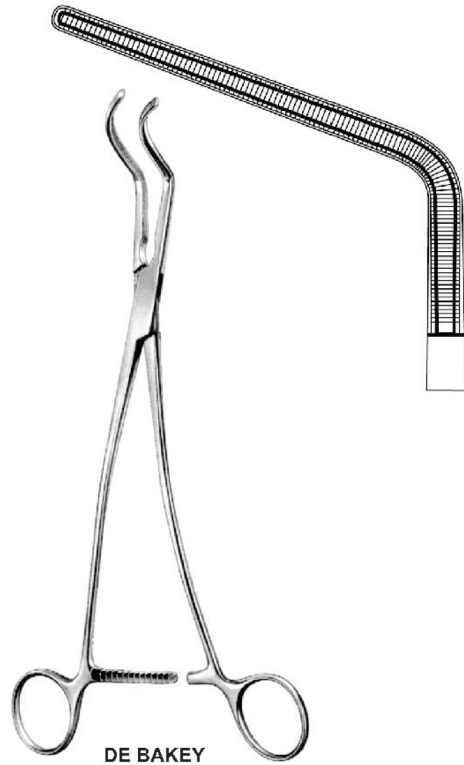

DE BAKEY
OI 19-5840-27
27.0cm

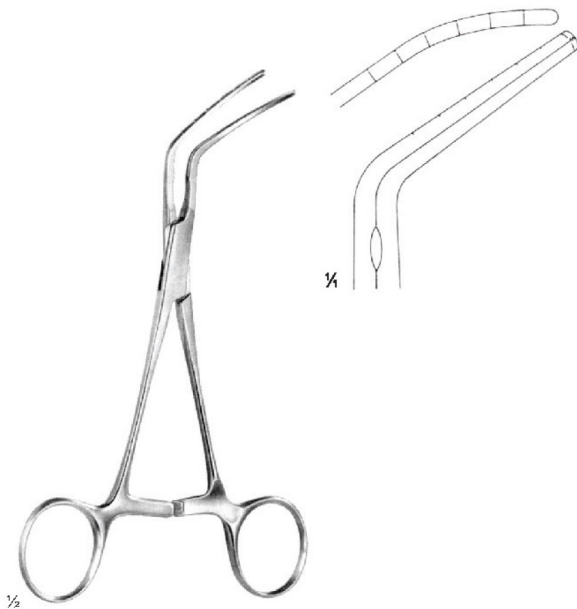

SUBRAMANIAN
OI 19-5841-16
16 cm/6 1/4"

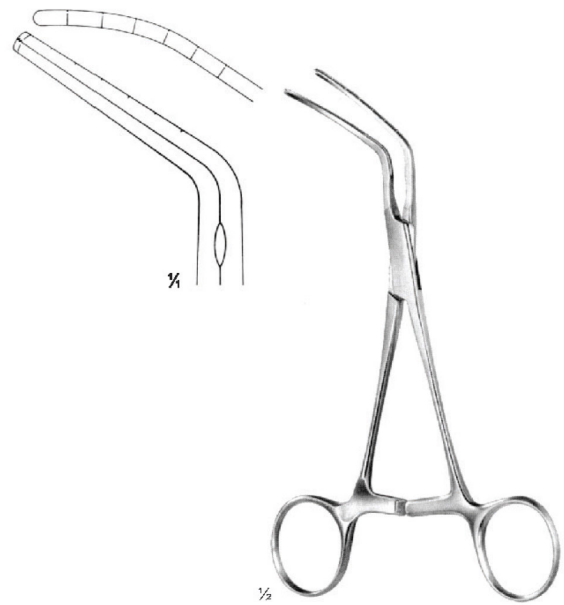

SUBRAMANIAN
OI 19-5842-16
16 cm/6 1/4"



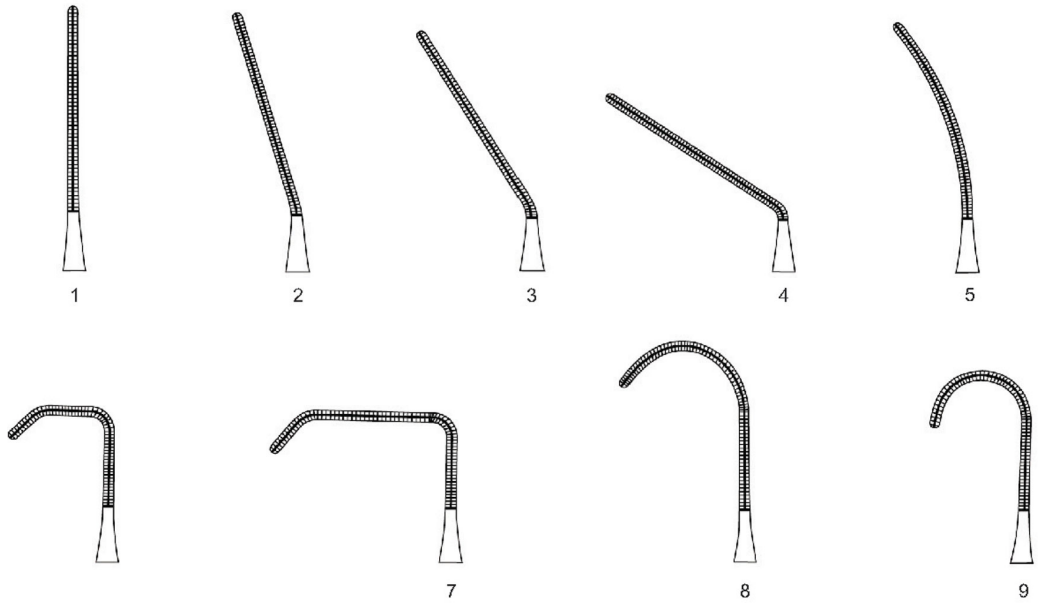

1 OI 19-5843-01 14.5cm
 2 OI 19-5843-02 14.5cm
 3 OI 19-5843-03 14.5cm
 4 OI 19-5843-04 13.5cm
 5 OI 19-5843-05 14.0cm
 6 OI 19-5843-06 13.5cm
 7 OI 19-5843-07 13.5cm
 8 OI 19-5843-08 14.0cm
 9 OI 19-5843-09 13.5cm



1 OI 19-5843-11 14.5cm
 2 OI 19-5843-12 14.5cm
 3 OI 19-5843-13 14.5cm
 4 OI 19-5843-14 13.5cm
 5 OI 19-5843-15 14.0cm
 6 OI 19-5843-16 13.5cm
 7 OI 19-5843-17 13.5cm
 8 OI 19-5843-18 14.0cm
 9 OI 19-5843-19 13.5cm



1 OI 19-5843-21 14.5cm
 2 OI 19-5843-22 14.5cm
 3 OI 19-5843-23 14.5cm
 4 OI 19-5843-24 13.5cm
 5 OI 19-5843-25 14.0cm
 6 OI 19-5843-26 13.5cm
 7 OI 19-5843-27 13.5cm
 8 OI 19-5843-28 14.0cm
 9 OI 19-5843-29 13.5cm



ATRAUMA



COOLEY
 OI 19-5844-16
 16.5 cm/6 1/2"



COOLEY
 OI 19-5845-16
 16 cm/6 1/4"



COOLEY
 OI 19-5846-15
 15.5 cm/6 1/8"

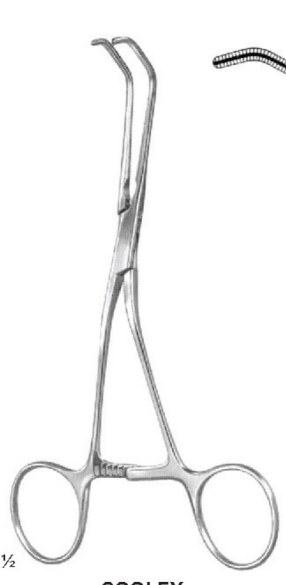

COOLEY
 OI 19-5847-15
 15.5 cm/6 1/8"

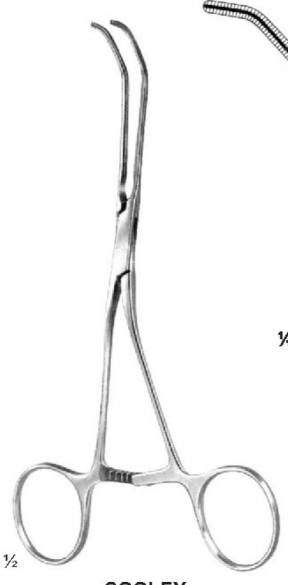

COOLEY
 OI 19-5848-16
 16 cm/6 1/4"



ATRAUMA

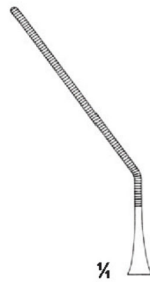

OI 19-5849-01
 12.5 cm/4 7/8"



OI 19-5849-02
 11.5 cm/4 1/2"



OI 19-5849-03
 11 cm/4 3/8"



CASTANEDA



OI 19-5849-04
 11.5 cm/4 1/2"

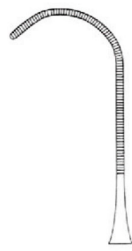

OI 19-5849-05
 12 cm/4 3/4"



OI 19-5849-06
 12 cm/4 3/4"



OI 19-5849-07
 12 cm/4 3/4"





ATRAUMA



ALLIS



ATRAUMA



DUVAL



1/4

13 mm

OI 19-5851-18 18 cm
OI 19-5851-20 20 cm
OI 19-5851-23 23 cm

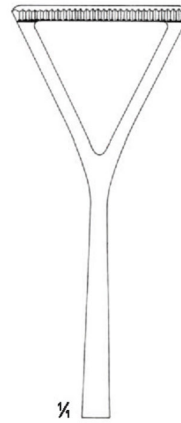

1/4

25 mm

OI 19-5852-18
OI 19-5852-20
OI 19-5852-23





ATRAUMA



OI 19-5853-25
25 cm/9 7/8"



OI 19-5853-26
26 cm/10 1/4"



SCHEIBE



OI 19-5854-18
18 cm/7 1/8"
narrow



OI 19-5854-20
20.5 cm/8 1/4"
medium



OI 19-5854-23
23 cm/9"
wide

ATRAUMA



DOYEN-ATRAUMA



OI 19-5855-14
 14 cm/5 1/2"



OI 19-5855-16
 16 cm/6 3/4"



OI 19-5855-18
 18.5 cm/7 1/4"



OI 19-5855-21
 21.5 cm/8 1/2"



OI 19-5855-23
 23.5 cm/9 1/4"

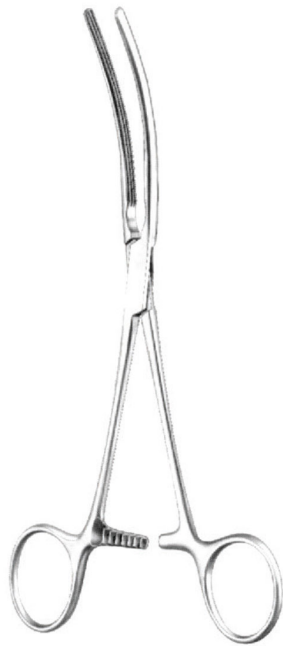

DOYEN-ATRAUMA



OI 19-5856-13
 13.5 cm/5 3/8"



OI 19-5856-16
 16 cm/6 3/4"

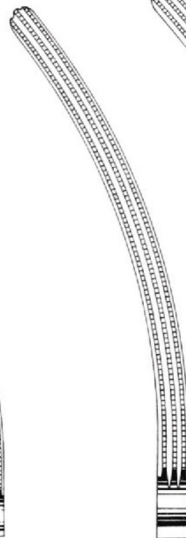

OI 19-5856-18
 18 cm/7 1/8"

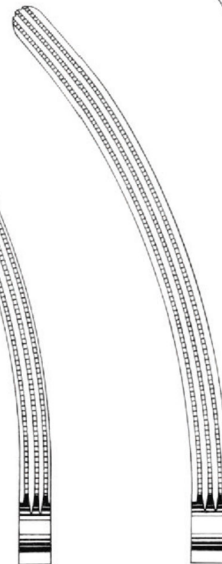

OI 19-5856-21
 21 cm/8 1/4"

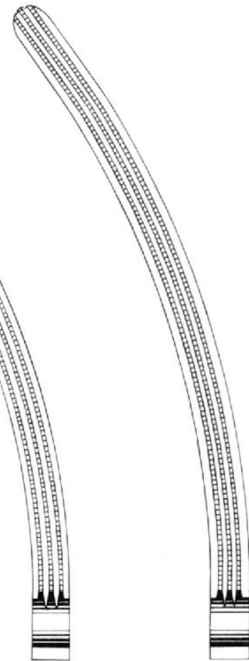

OI 19-5856-23
 23 cm/9"



- EN — Sigmoid Anastomosis Forceps
- DE — Rektum-Anastomosenklemmen
- ES — Pinzas para anastomosis rectales



ATRAUMA



HAYES

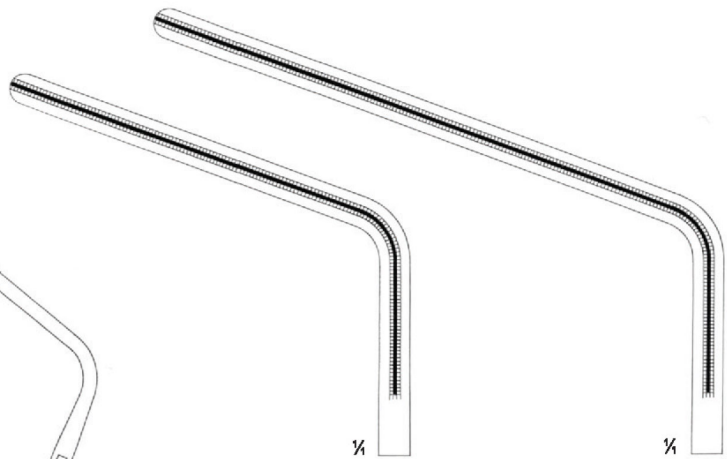

¼

OI 19-5857-26
26 cm/10 ½"

¼

OI 19-5857-28
28 cm/11"

ATRAUMA

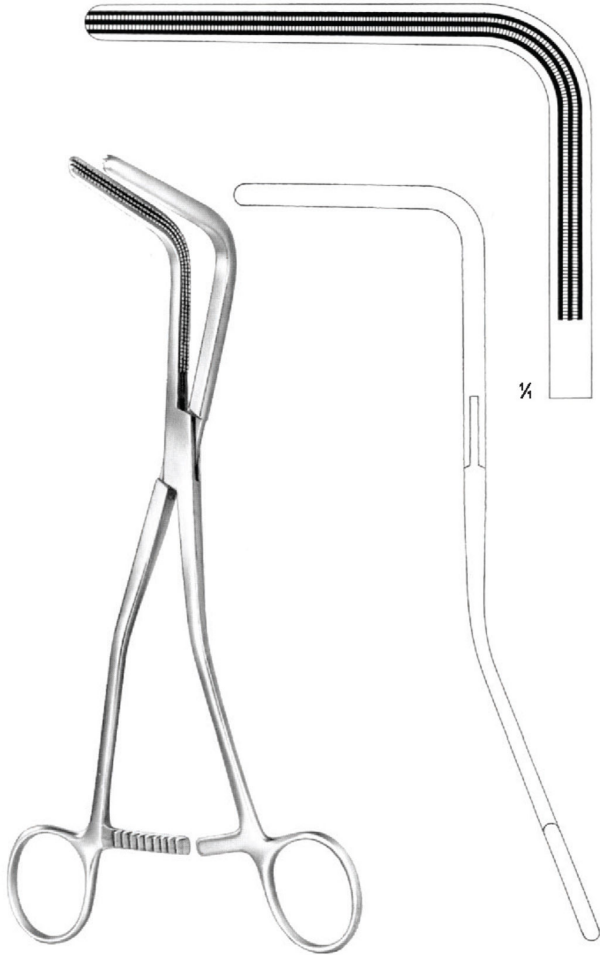

VEIDENHEIMER
OI 19-5858-25
25 cm/9 7/8"



FEHLAND
OI 19-5859-24
24 cm/9 1/2"



- EN — Sigmoid Anastomosis Forceps
- DE — Rektum-Anastomosenklemmen
- ES — Pinzas para anastomosis rectales

ATRAUMA



RESANO
OI 19-5860-30
30 cm/12"