

EN Kidney, Liver, Gall Stone, Urology

DE Niere, Leber, Galle, Urologie

ES Riñón, Hígado, Bilis, Urología

Page 620 to 638



- EN — Kidney Pedicle Clamp Forceps
- DE — Kidney Gestielte Klammerzange
- ES — Pinzas de riñón Clamp pediculares



Guyon



OI 25-7301-20
20 cm/8"



OI 25-7301-22
22 cm/8¾"



OI 25-7301-24
24 cm/9½"

Atrauma



OI 25-7302-23
23 cm/9"



OI 25-7302-24
24 cm/9½"



Guyon
OI 25-7303-23
23 cm/9"

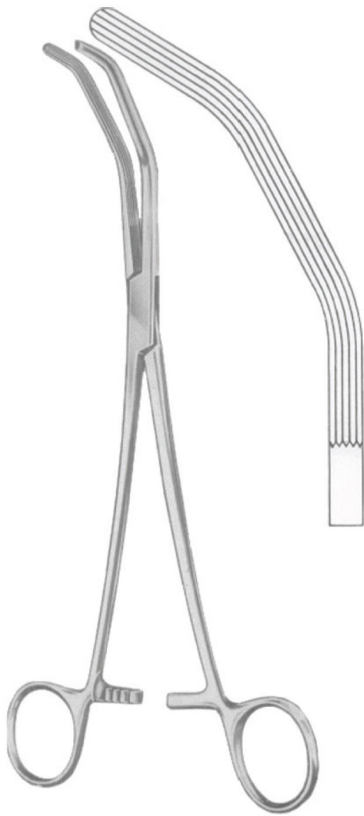

Herrick
OI 25-7304-23
23 cm/9"

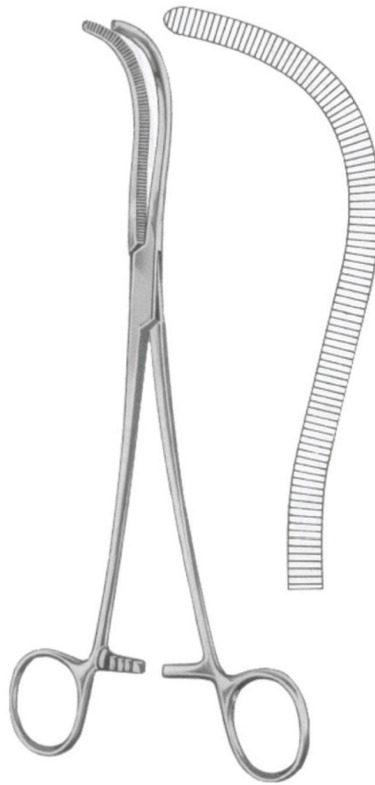

Mayo-Guyon
OI 25-7305-23
23 cm/9"



Stille
OI 25-7306-23
23 cm/9"





Elsasser
OI 25-7307-20
20 cm/8"

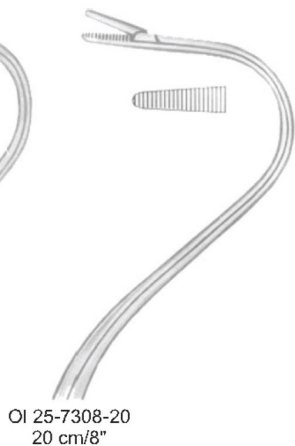

OI 25-7308-20
20 cm/8"

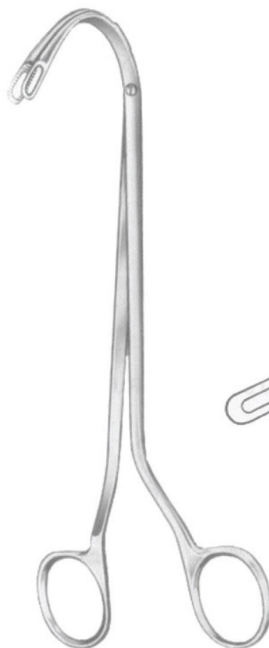

Randall

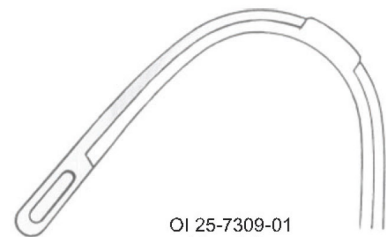

OI 25-7309-01
19 cm/7½"



OI 25-7309-02
19 cm/7½"



Randall



Fig. 4
OI 25-7310-04
22 cm/8¾"



Fig. 3
OI 25-7310-03
22 cm/8¾"

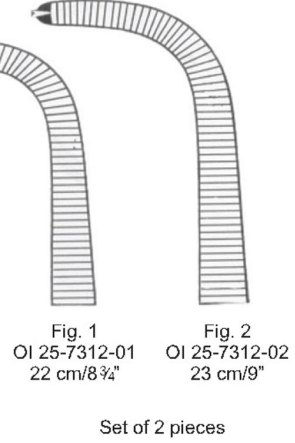
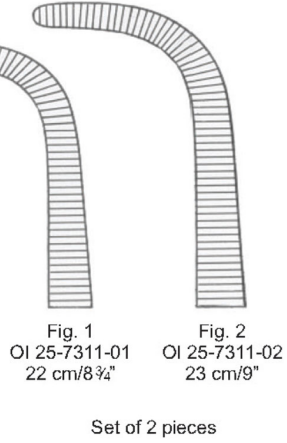

Fig. 2
OI 25-7310-02
22 cm/8¾"

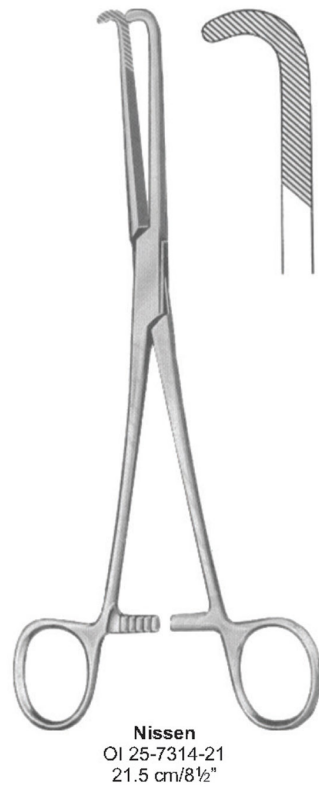
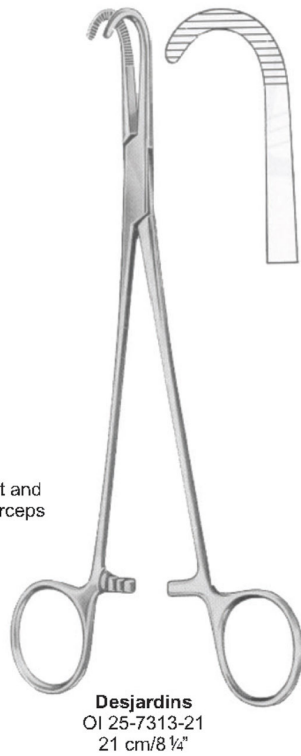

Fig. 1
OI 25-7310-01
23 cm/9"

Gall Duct Forceps ● EN
 Gall Duct Zange ● DE
 Pinzas conducto biliar ● ES



Gall duct and cystic forceps



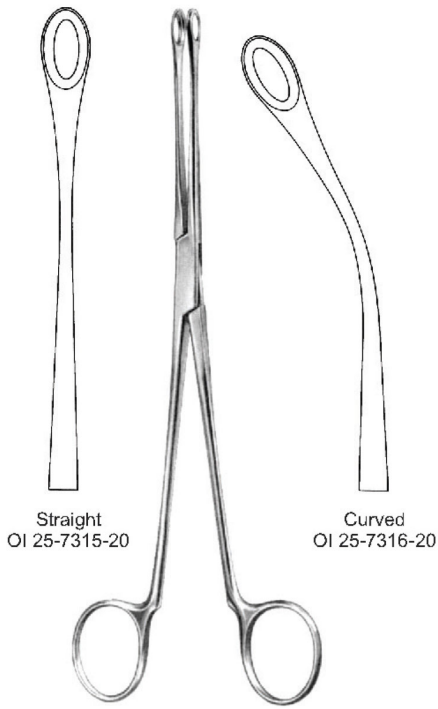

Straight
OI 25-7315-20

Curved
OI 25-7316-20

Blake
20 cm/8"



Straight
OI 25-7317-20

Mayo-Blake
20 cm/8"



Curved
OI 25-7318-20

Mayo-Blake
20 cm/8"



Czerny
OI 25-7319-24
24.5 cm/9 3/4"

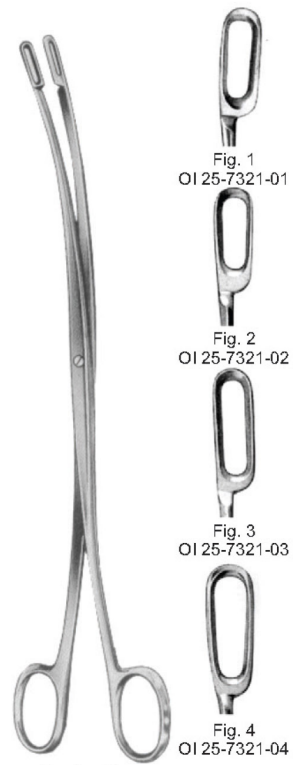

Fig. 1
OI 25-7321-01

Fig. 2
OI 25-7321-02

Fig. 3
OI 25-7321-03

Fig. 4
OI 25-7321-04

Desjardins
23 cm/9"

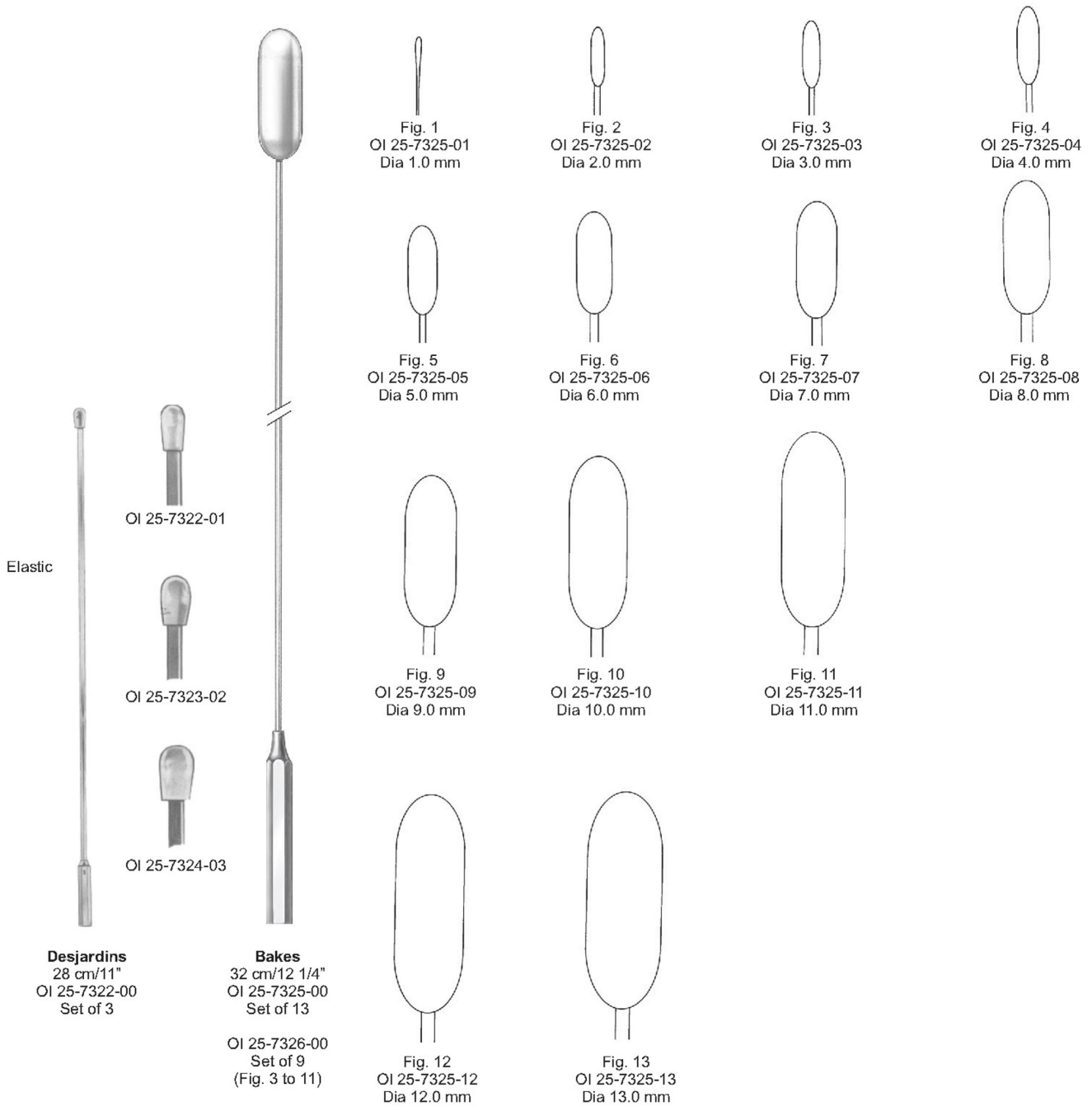



Desjardins
30 cm/12"
OI 25-7327-00
Set of 4



Luer-Koerte
32 cm/12½"
OI 25-7328-00
Set of 8

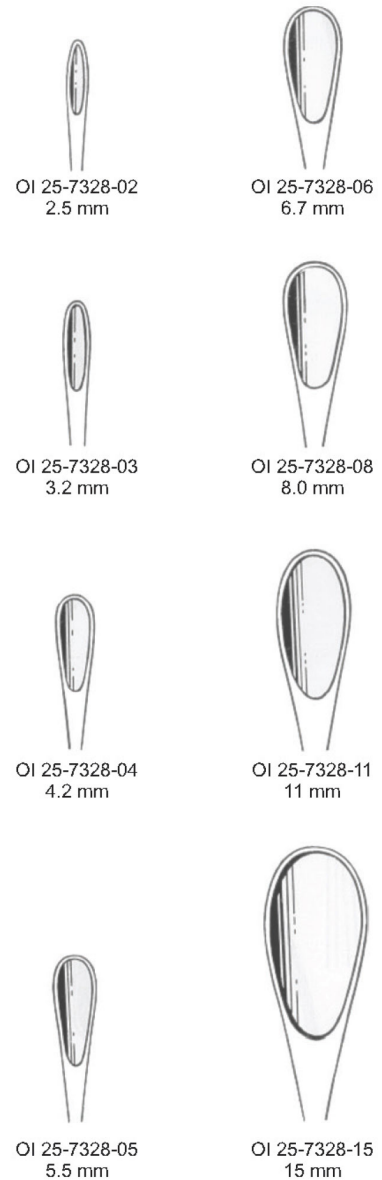



Mayo
 OI 25-7329-28
 28 cm/11"



Mayo
 26.5 cm/10½"



Fig. 1
 OI 25-7330-01



Fig. 2
 OI 25-7330-02



Fig. 3
 OI 25-7330-03



Moore
 26-8506-28
 28 cm/11"

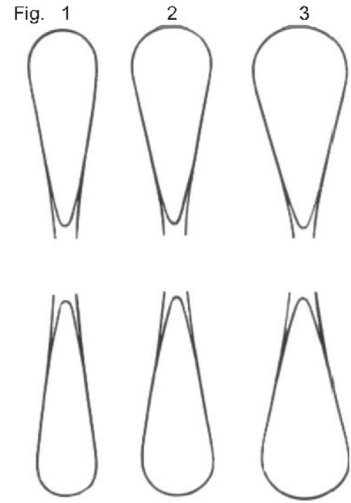

Fig.
 1 OI 25-7331-01
 2 OI 25-7331-02
 3 OI 25-7331-03



Fergusson
 24 cm/9½"





Young
OI 25-7332-22
22 cm/8¾"



Young
OI 25-7333-21
21 cm/8¼"



Young
OI 25-7334-22
22 cm/8¾"

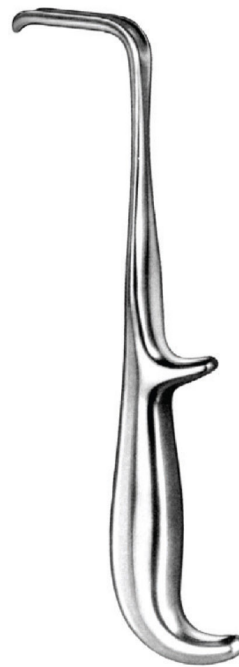

Young
OI 25-7335-21
21 cm/8¼"



MILLIN
OI 25-7336-01
24.5cm



OI 25-7336-02 23.5cm



OI 25-7336-03 23.0cm

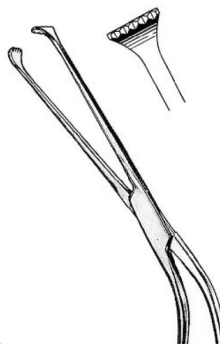

OI 25-7336-04 23.0cm

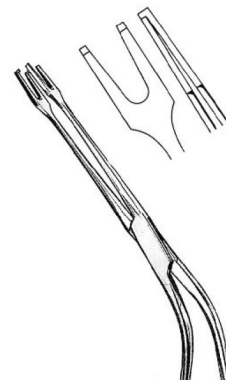

OI 25-7336-05 24.0cm



Millin
 OI 25-7339-00

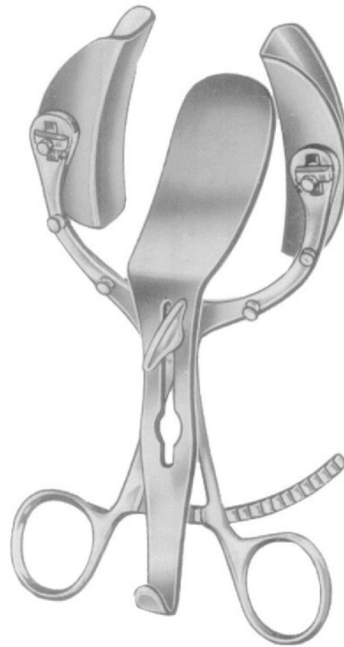

Legueu
 OI 25-7340-00

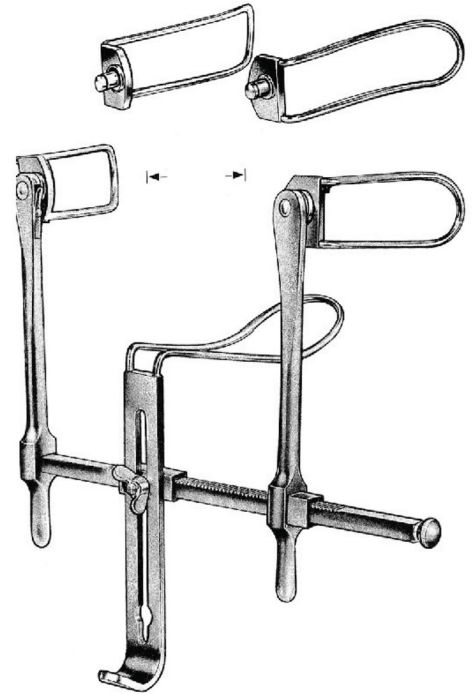

Gosset
 OI 25-7341-00

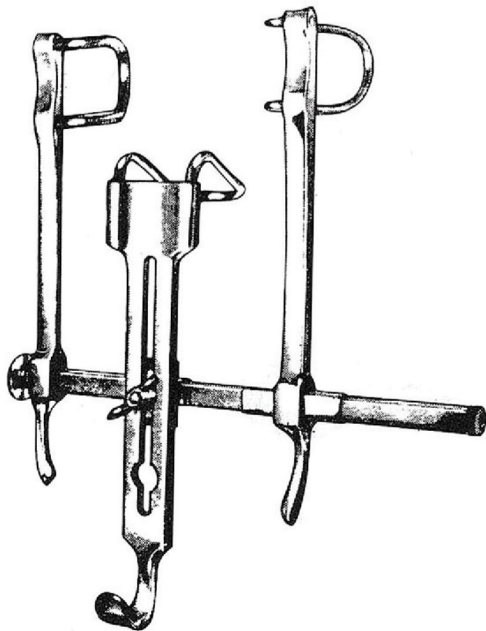

Pantings
 OI 25-7342-00

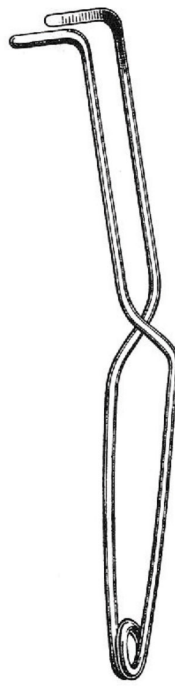

Millin
 OI 25-7342-01
 24 cm/9½"

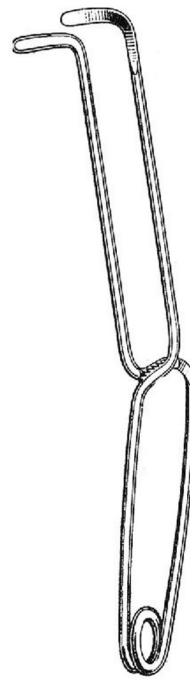

Millin
 OI 25-7342-02
 24 cm/9½"



Millin
 OI 25-7342-03
 24 cm/9½"



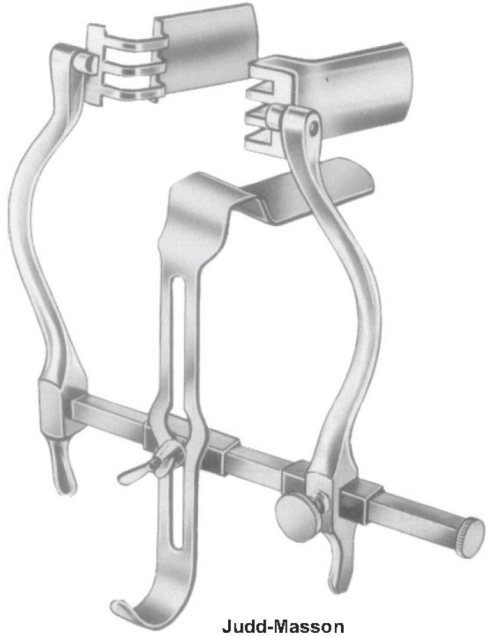

Judd-Masson
OI 25-7343-00

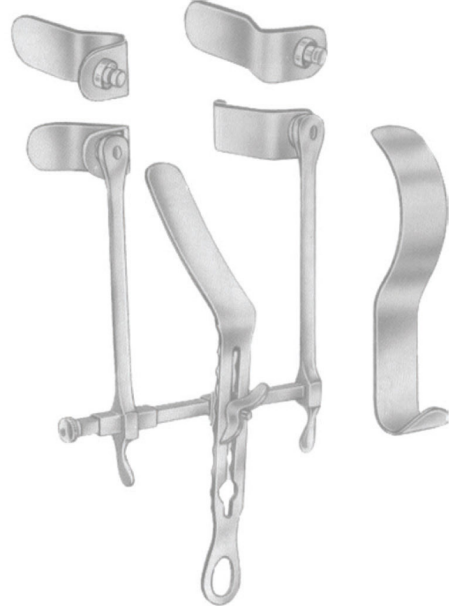

Thomson-Walker
OI 25-7344-00



35 mm

Legueu
OI 25-7345-27
27 cm/10½"



67 mm

Kocher
OI 25-7345-26
26 cm/10¼"

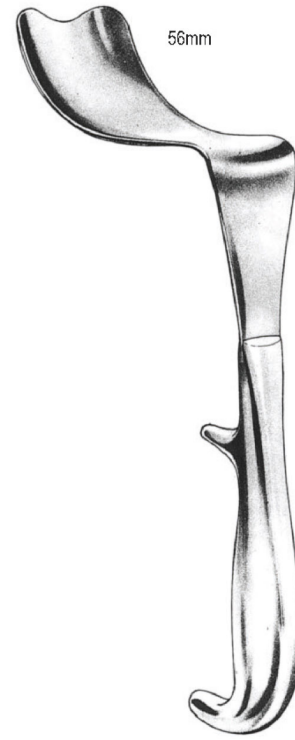

56mm

Kocher
OI 25-7346-26
26 cm/10¼"



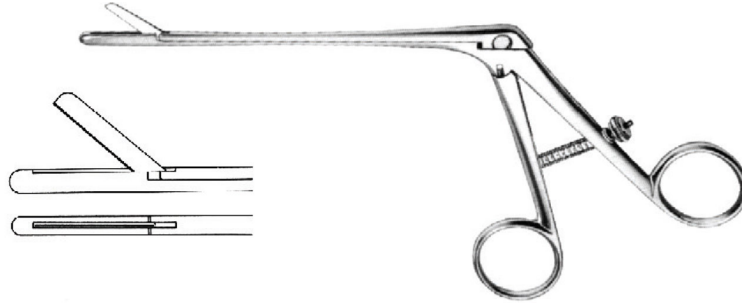

SACHSE
OI 25-7347-12

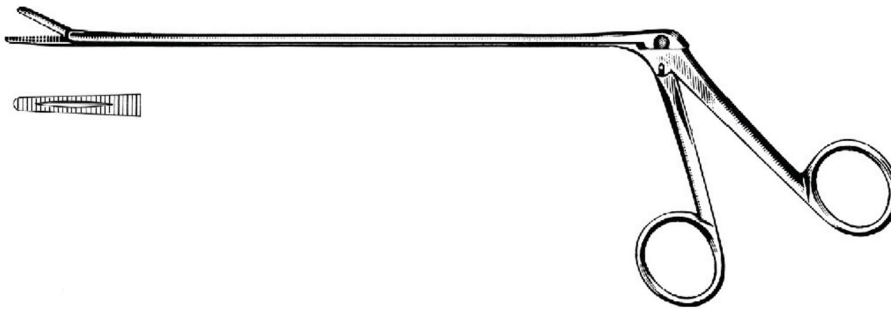

MATHIEU
OI 25-7348-20 20.0cm
OI 25-7348-28 28.0cm

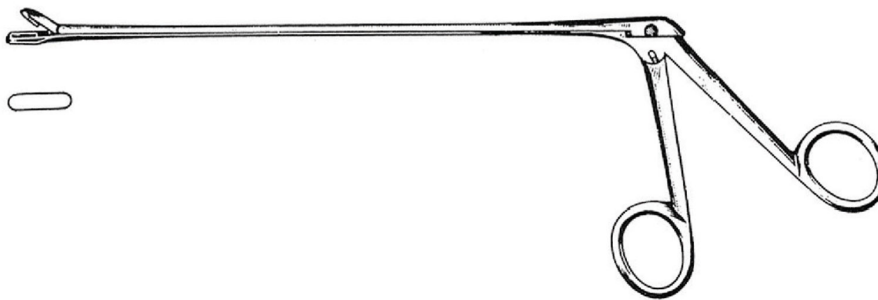

MATHIEU
OI 25-7349-20 20.0cm
OI 25-7349-28 28.0cm





STOCKMANN
OI 25-7350-08



ZIESER MEAEUS CLAMP
OI 25-7351-10
10.0cm

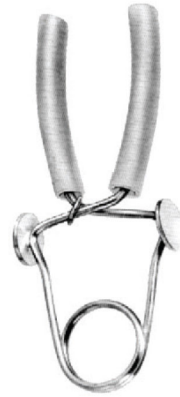

STRAUSS
OI 25-7352-11



THOMSON-WALKER
OI 25-7353-00



LEWKOWITZ
OI 25-7354-26
26.0cm



OI 25-7355-26

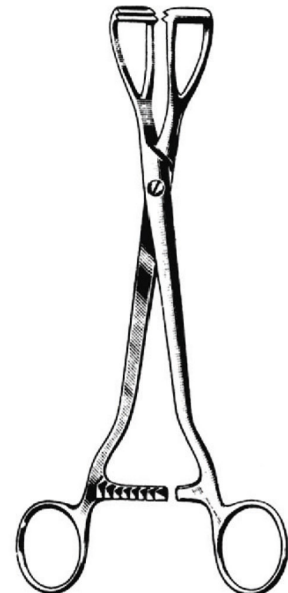

YOUNG
OI 25-7356-20
20.0cm



GAMCO
 OI 25-7357-08 8mm Ø, baby size
 OI 25-7357-11 11mm Ø, child size
 OI 25-7357-13 13mm Ø, child size
 OI 25-7357-16 16mm Ø, adolescent size
 OI 25-7357-21 21mm Ø, adolescent size
 OI 25-7357-26 26mm Ø, men's size
 OI 25-7357-32 32mm Ø, men's size



WINKELMANN
 OI 25-7358-12 12mm Ø
 OI 25-7358-16 16mm Ø
 OI 25-7358-20 20mm Ø

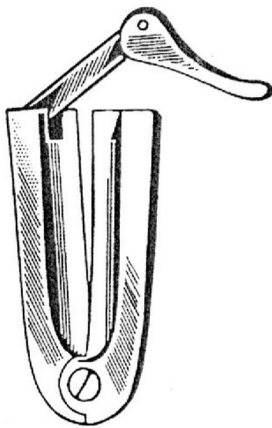

MOGEN
 OI 25-7359-00
 58.0162.00

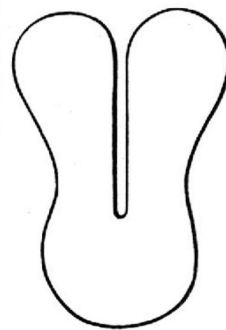

CIRCUMCISION SHIELD
 OI 25-7360-10
 10.0cm



CIRCUMCISION PROBE
 OI 25-7361-15
 15.0cm



- EN —●— Hemia Directors, Suction Tube, Cord Hook
- DE —●— Sonden, Aspirationskanulen, Haken für den saenenstrang
- ES —●— Sondas, canulas de aspiracion, ganchol/el cordon



CHILD
OI 25-7362-00



KEY
OI 25-7363-00

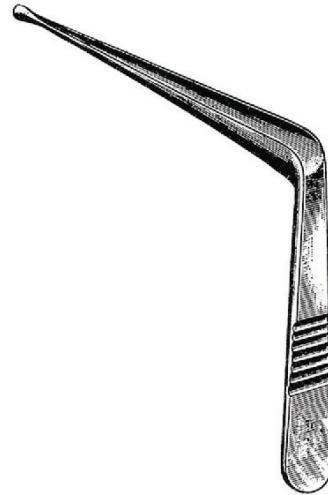

TEALE
OI 25-7364-00

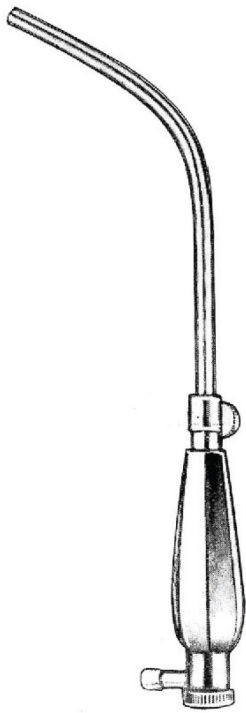

MILLIN
OI 25-7365-00



CORD HOOK
OI 25-7366-16
16.0cm



GUTTMANN
OI 25-7367-26
26.0cm

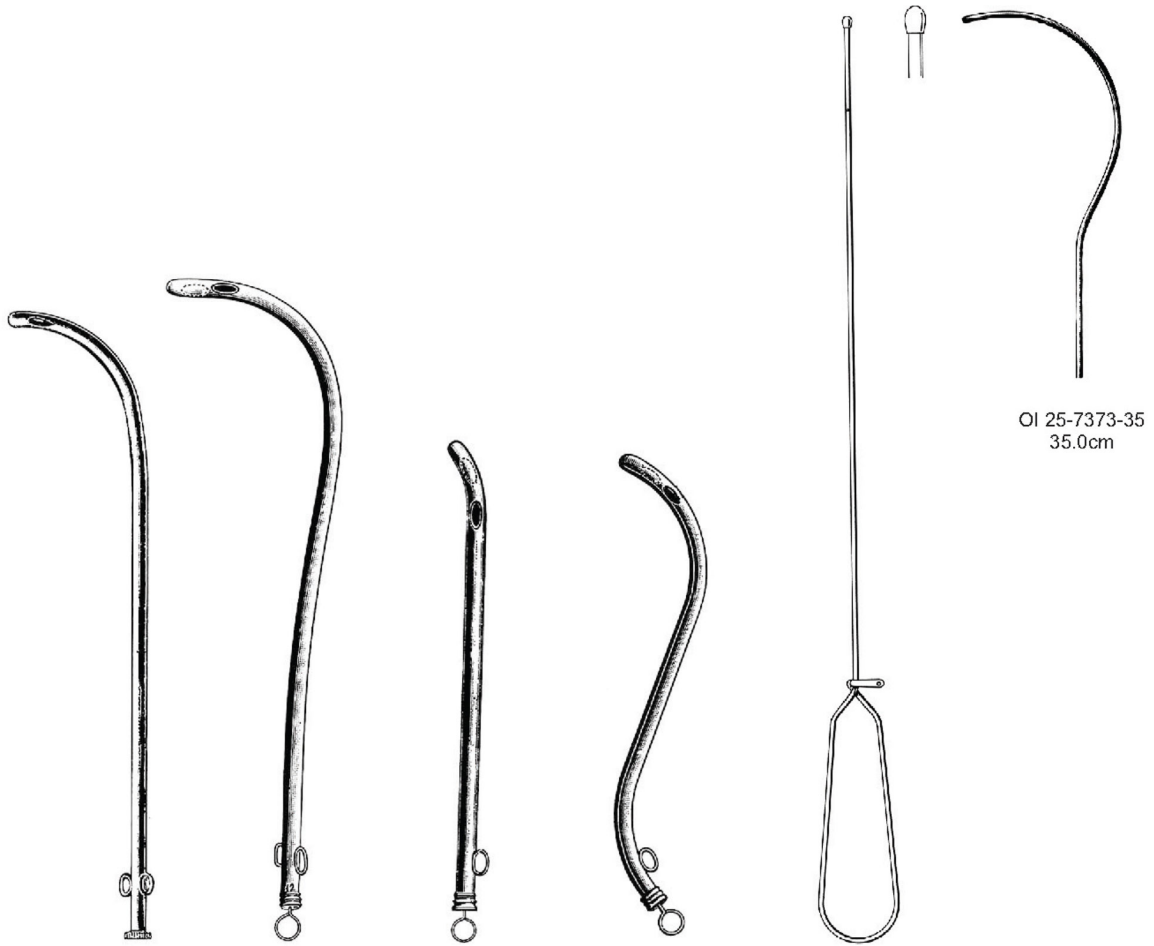

OI 25-7373-35
 35.0cm

OI 25-7372-39
 39.0cm

COXETER

F.G.	MALE		FEMALE	MALE	
	27.0cm	28.0cm		20.0cm	20.0cm
6	OI 25-7368-06	OI 25-7369-06	OI 25-7370-06	OI 25-7371-06	
8	OI 25-7368-08	OI 25-7369-08	OI 25-7370-08	OI 25-7371-08	
10	OI 25-7368-10	OI 25-7369-10	OI 25-7370-10	OI 25-7371-10	
12	OI 25-7368-12	OI 25-7369-12	OI 25-7370-12	OI 25-7371-12	
14	OI 25-7368-14	OI 25-7369-14	OI 25-7370-14	OI 25-7371-14	
16	OI 25-7368-16	OI 25-7369-16	OI 25-7370-16	OI 25-7371-16	
18	OI 25-7368-18	OI 25-7369-18	OI 25-7370-18	OI 25-7371-18	
20	OI 25-7368-20	OI 25-7369-20	OI 25-7370-20	OI 25-7371-20	
22	OI 25-7368-22	OI 25-7369-22	OI 25-7370-22	OI 25-7371-22	
24	OI 25-7368-24	OI 25-7369-24	OI 25-7370-24	OI 25-7371-24	



CLUTTON

set	OI 25-7374-00
F.G.	
06/10	OI 25-7374-06
08/12	OI 25-7374-08
10/14	OI 25-7374-10
12/16	OI 25-7374-12
14/18	OI 25-7374-14
16/20	OI 25-7374-16
18/22	OI 25-7374-18
20/24	OI 25-7374-20
22/26	OI 25-7374-22
24/28	OI 25-7374-24
26/30	OI 25-7374-26
28/32	OI 25-7374-28



LISTER

set	OI 25-7375-00
F.G.	
00/1	OI 25-7375-01
0/2	OI 25-7375-02
1/3	OI 25-7375-03
1/4	OI 25-7375-04
2/5	OI 25-7375-05
3/6	OI 25-7375-06
4/7	OI 25-7375-07
5/8	OI 25-7375-08
6/9	OI 25-7375-09
7/10	OI 25-7375-10
8/11	OI 25-7375-11
9/12	OI 25-7375-12
10/13	OI 25-7375-13
11/14	OI 25-7375-14
12/15	OI 25-7375-15
13/16	OI 25-7375-16
14/17	OI 25-7375-17
15/18	OI 25-7375-18



WHEELHOUSE
OI 25-7377-00

F.G.	
06	OI 25-7376-06
08	OI 25-7376-08
10	OI 25-7376-10
12	OI 25-7376-12
14	OI 25-7376-14
16	OI 25-7376-16

Dilating Bougies — EN
 Dilationsbougies — DE
 Bujas dilatadoras — ES



	VAN BUREN OI 25-7378-00 set No. 8-36	GUYON OI 25-7379-00 set No. 10-30	GUYON OI 25-7380-00 set No. 10-30	DITTEL OI 25-7381-00 set No. 10-30	DITTEL OI 25-7382-00 set No. 8-30
(French)					
8	OI 25-7378-08				OI 25-7382-08
9					OI 25-7382-09
10	OI 25-7378-10	OI 25-7379-10	OI 25-7380-10	OI 25-7381-10	OI 25-7382-10
11		OI 25-7379-11	OI 25-7380-11	OI 25-7381-11	OI 25-7382-11
12	OI 25-7378-12	OI 25-7379-12	OI 25-7380-12	OI 25-7381-12	OI 25-7382-12
13		OI 25-7379-13	OI 25-7380-13	OI 25-7381-13	OI 25-7382-13
14	OI 25-7378-14	OI 25-7379-14	OI 25-7380-14	OI 25-7381-14	OI 25-7382-14
15		OI 25-7379-15	OI 25-7380-15	OI 25-7381-15	OI 25-7382-15
16	OI 25-7378-16	OI 25-7379-16	OI 25-7380-16	OI 25-7381-16	OI 25-7382-16
17		OI 25-7379-17	OI 25-7380-17	OI 25-7381-17	OI 25-7382-17
18	OI 25-7378-18	OI 25-7379-18	OI 25-7380-18	OI 25-7381-18	OI 25-7382-18
19		OI 25-7379-19	OI 25-7380-19	OI 25-7381-19	OI 25-7382-19
20	OI 25-7378-20	OI 25-7379-20	OI 25-7380-20	OI 25-7381-20	OI 25-7382-20
21		OI 25-7379-21	OI 25-7380-21	OI 25-7381-21	OI 25-7382-21
22	OI 25-7378-22	OI 25-7379-22	OI 25-7380-22	OI 25-7381-22	OI 25-7382-22
23		OI 25-7379-23	OI 25-7380-23	OI 25-7381-23	OI 25-7382-23
24	OI 25-7378-24	OI 25-7379-24	OI 25-7380-24	OI 25-7381-24	OI 25-7382-24
25		OI 25-7379-25	OI 25-7380-25	OI 25-7381-25	OI 25-7382-25
26	OI 25-7378-26	OI 25-7379-26	OI 25-7380-26	OI 25-7381-26	OI 25-7382-26
27		OI 25-7379-27	OI 25-7380-27	OI 25-7381-27	OI 25-7382-27
28	OI 25-7378-28	OI 25-7379-28	OI 25-7380-28	OI 25-7381-28	OI 25-7382-28
29		OI 25-7379-29	OI 25-7380-29	OI 25-7381-29	OI 25-7382-29
30	OI 25-7378-30	OI 25-7379-30	OI 25-7380-30	OI 25-7381-30	OI 25-7382-30
31	OI 25-7378-31				
32	OI 25-7378-32				
33	OI 25-7378-33				
34	OI 25-7378-34				
35	OI 25-7378-35				
36	OI 25-7378-36				



- EN —● Set of Dilating Sounds
 DE —● Dilatationsbesteck
 ES —● Juego de bujias dilatadoras

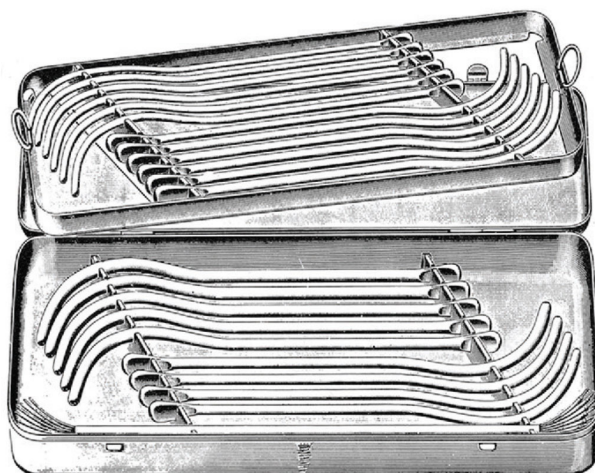

VAN BUREN
 OI 25-7383-00
 420x175x40 mm
 set in metal case containing
 21 bougies



GUYON
 OI 25-7384-00
 420x175x40mm
 set in metal case containing
 21 bougies
 6 liliform in metal tube