

**EN** Neurosurgery

**DE** Neurochirurgie

**ES** Neuro Cirugía

**Page 373 to 387**

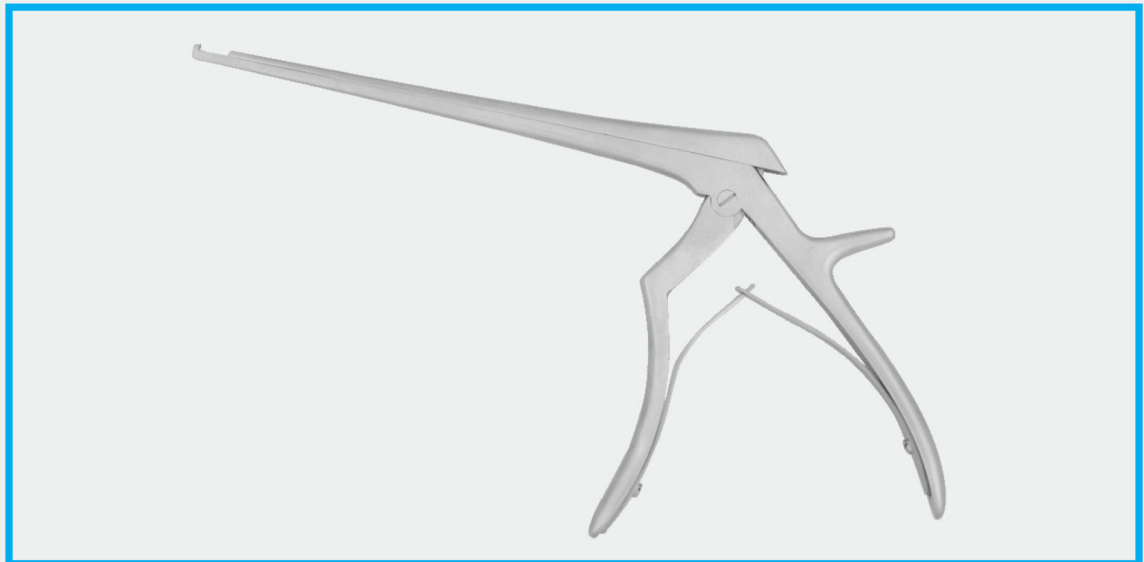

- EN —● Dura Hooks, Nerve Hooks, Dura Dissectors
- DE —● Durahaken, Nervhaken, Dura-Dissektoren
- ES —● Ganchos para dura-madre, Ganchos para nervios, Disecadores de dura-madre



**FRAZIER**  
OI 18-5301-15  
15 cm/5 1/4"



**HOEN**  
OI 18-5302-15  
15 cm/5 1/4"



**HOEN**  
OI 18-5303-15  
15 cm/5 1/4"



**SACHS**  
OI 18-5304-21  
21 cm/8 1/4"

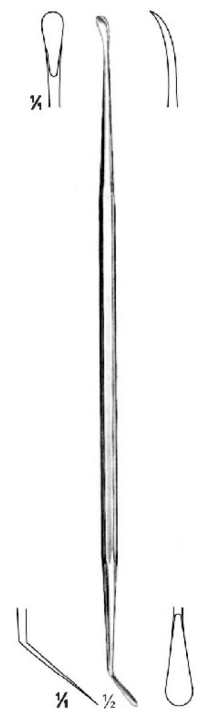

**MILLIGAN**  
OI 18-5305-21  
21 cm/8 1/4"

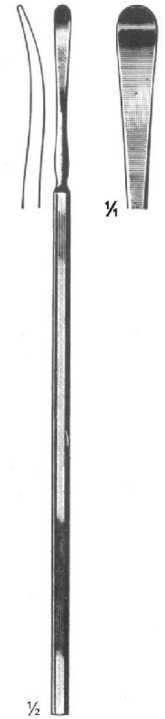

**SACHS**  
OI 18-5306-21  
21 cm/8 1/4"

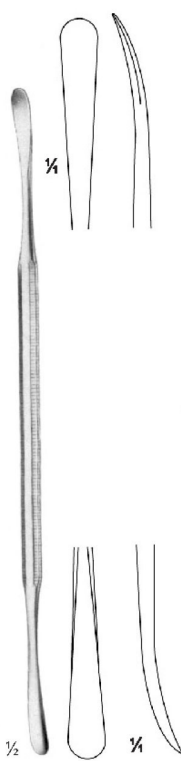

OI 18-5307-22  
22 cm/8 3/4"

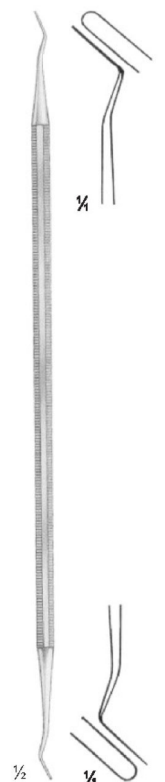

**WOODSON**  
OI 18-5308-25  
25 cm/9 1/4"



**DAVIS**  
OI 18-5309-24  
24.5 cm/9 3/4"



OI 18-5310-21  
21 cm/8 1/4"



**FAGER**  
OI 18-5311-20  
20 cm/7 1/2"



**FAGER**  
OI 18-5312-20  
20 cm/7 1/4"

NEUROSURGERY



1/2  
**LOVE**  
OI 18-5313-21  
21.5 cm/8 1/2"

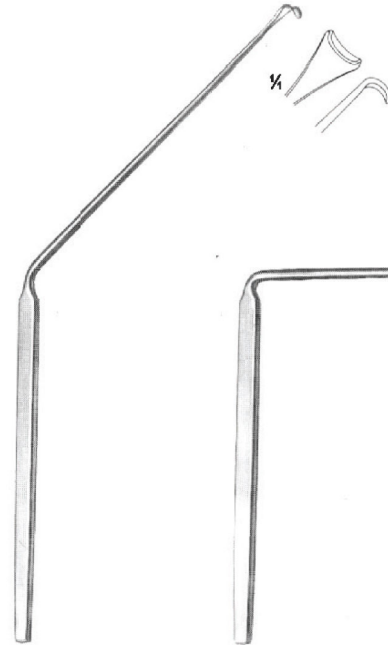

1/2  
**LOVE**  
OI 18-5314-17  
17.5 cm/6 7/8"

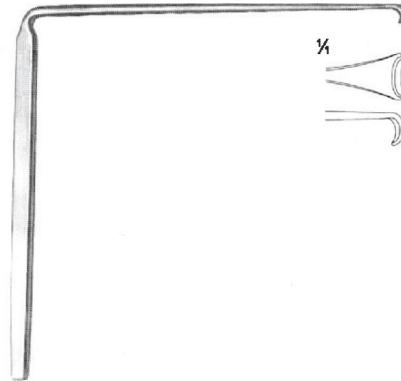

1/2  
**LOVE**  
OI 18-5315-11  
11 cm/4 3/8"

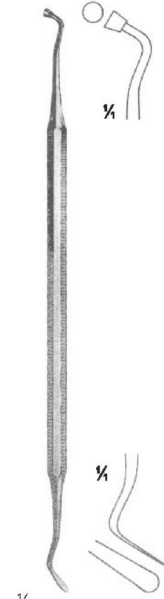

1/2  
**WOODSON**  
OI 18-5316-17  
17 cm/6 3/4"

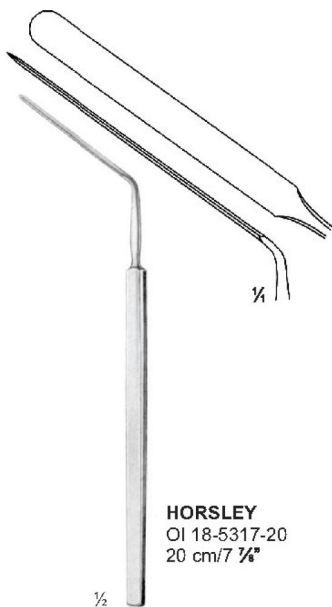

1/2  
**HORSLEY**  
OI 18-5317-20  
20 cm/7 7/8"

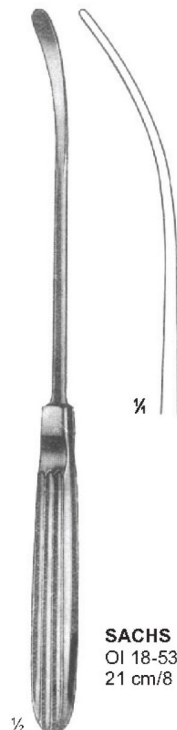

1/2  
**SACHS**  
OI 18-5318-21  
21 cm/8 1/4"

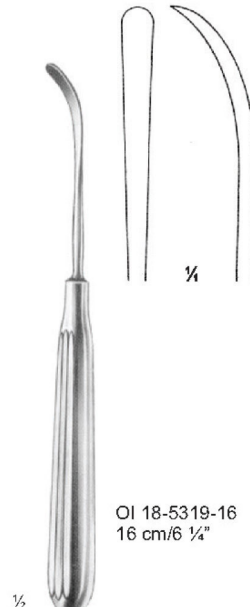

1/2  
OI 18-5319-16  
16 cm/6 1/4"

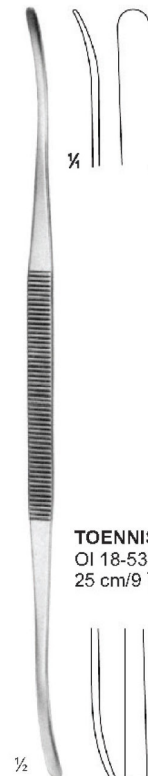

1/2  
**TOENNIS**  
OI 18-5320-20  
25 cm/9 7/8"



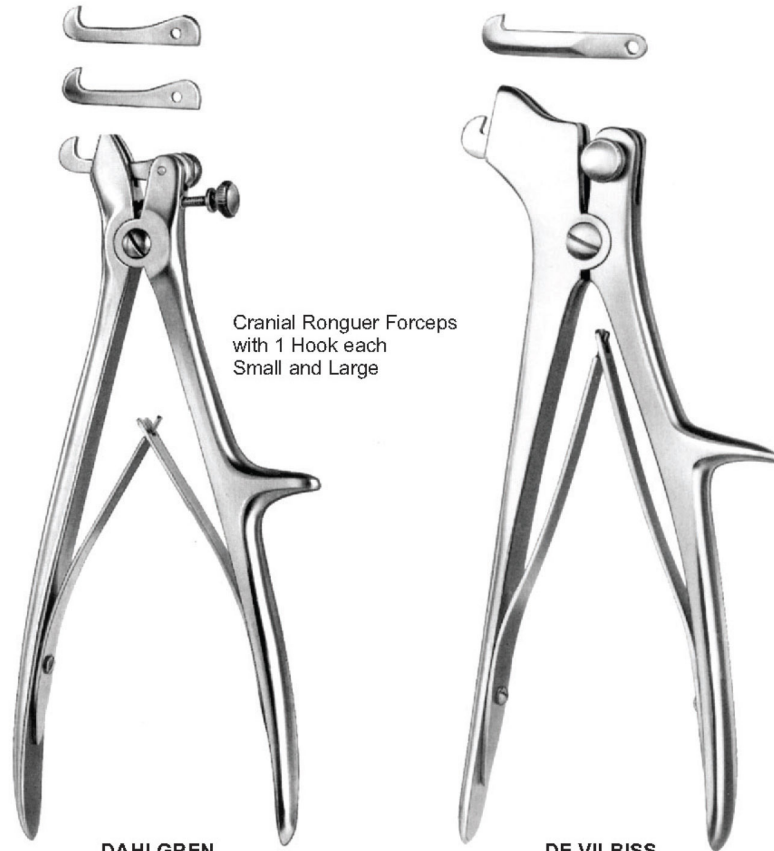

Cranial Rongeur Forceps  
with 1 Hook each  
Small and Large

**DAHLGREN**  
OI 18-5321-20  
20 cm/7 7/8"

**DE VILBISS**  
OI 18-5322-21  
21 cm/8 1/4"



**McKENZIE**  
OI 18-5323-15 15cm/5 7/8"  
OI 18-5323-19 19cm/7 1/2"

**McKENZIE**  
OI 18-5324-15 15cm/5 7/8"  
OI 18-5324-19 19cm/7 1/2"

**RANEY**  
OI 18-5325  
Applying and removing  
forceps for scalp hemostasis clip



**GIGLI-WIRE SAW**  
 2 wires twisted

- OI 18-5326-30 30cm
- OI 18-5326-40 40cm
- OI 18-5326-50 50cm
- OI 18-5326-60 60cm
- OI 18-5326-70 70cm

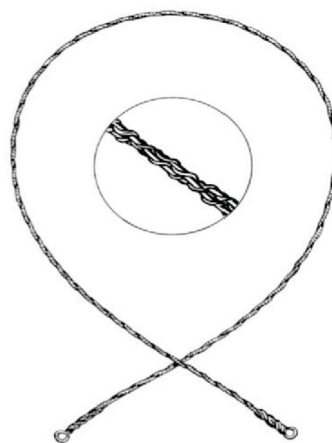

**GIGLI-WIRE SAW**  
 6 wires twisted

- OI 18-5327-30 30cm
- OI 18-5327-40 40cm
- OI 18-5327-50 50cm



**GIGLI**  
 OI 18-5328-07  
 7 cm/2 3/4"  
 Hook handle  
 for wire saw



**De MARTEL**  
 OI 18-5329-33  
 33 cm/13"  
 Conductor for  
 wire saws

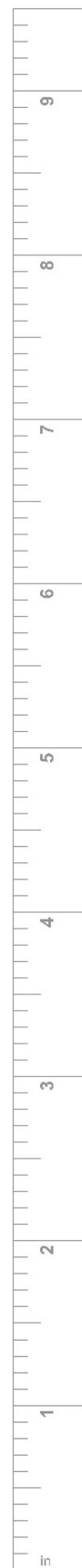



**CUSHING**  
 OI 18-5330-17 17cm/6 3/4"  
 OI 18-5330-20 20cm/7 7/8"  
 OI 18-5330-28 28cm/11"



**OLIVECROWNA**  
 18 cm/7 1/8"  
 width of spatulas

Concave upper end  
 OI 18-5331-18 7 + 9 mm  
 OI 18-5332-18 11 + 13 mm  
 OI 18-5333-18 15 + 18 mm  
 OI 18-5334-18 18 + 22 mm



Convex lower end  
 OI 18-5335-18  
 OI 18-5336-18  
 OI 18-5337-18  
 OI 18-5338-18



**SCOVILLE**  
 OI 18-5339-23  
 23 cm/9"

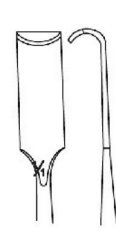

**HOLSHER**  
 OI 18-5340-24  
 24 cm/9 1/2"

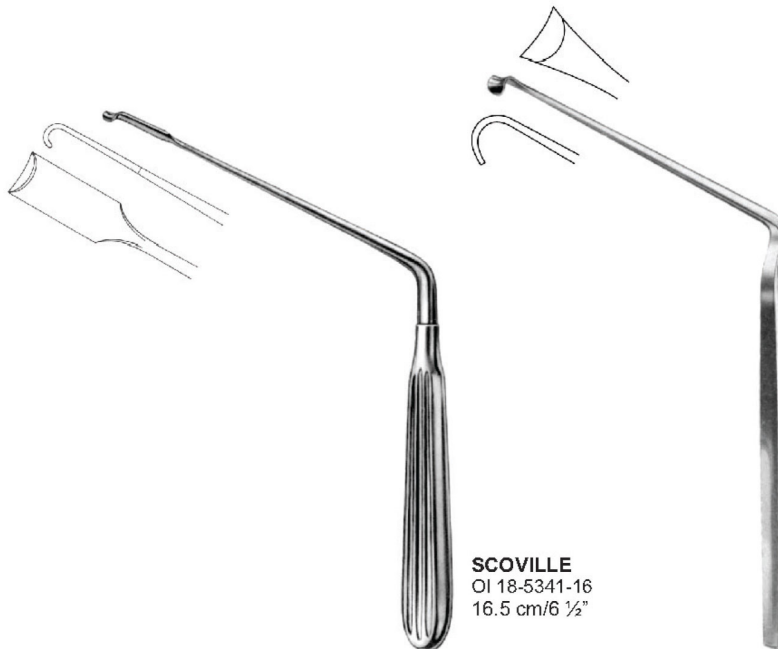
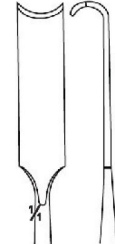

**SCOVILLE**  
 OI 18-5341-16  
 16.5 cm/6 1/2"

OI 18-5342-21  
 21 cm/8 1/4"



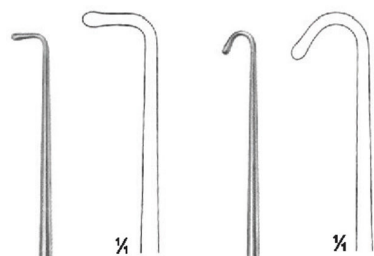

**GRONINGEN**  
 OI 18-5343-26  
 26.5 cm/10 3/8"

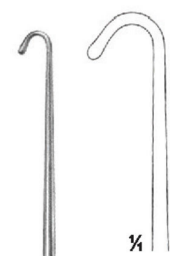

**GRONINGEN**  
 OI 18-5344-26  
 26.5 cm/10 3/8"



**CUSHING**



Fig. 1  
 OI 18-5345-19  
 19 cm/7 1/2"



**CUSHING**



Fig. 2  
 OI 18-5346-19  
 19 cm/7 1/2"



**SMITHWICK**



DF-237-2787  
 17 cm/6 3/4"



OI 18-5347-21  
 21 cm/8 1/4"

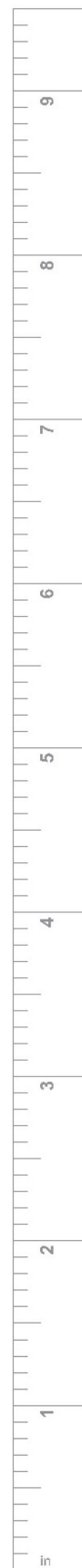





**GRAHAM**  
OI 18-5348-16  
16.5 cm/6 1/2"



**SACHS**  
OI 18-5349-17  
17 cm/6 3/4"



**FRAZIER**

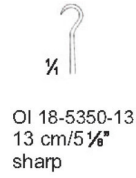

OI 18-5350-13  
13 cm/5 1/8"  
sharp



OI 18-5350-18  
18 cm/7 1/8"  
sharp



**ADSON**  
OI 18-5351-20  
20 cm/7 7/8"





**KRAYENBÜHL**  
19 cm / 7 1/2"



Fig. 1  
OI 18-5352-19



Fig. 2  
OI 18-5353-19

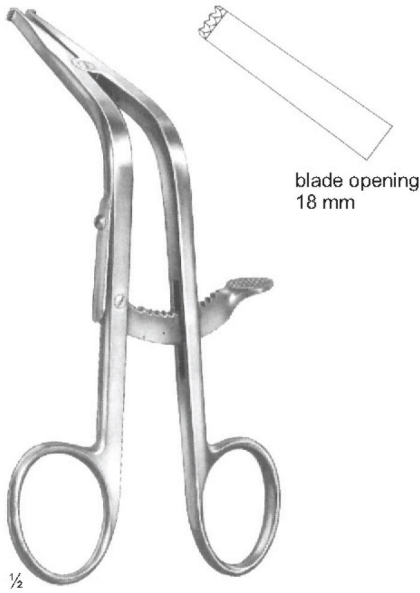

Fig. 1  
OI 18-5354-19

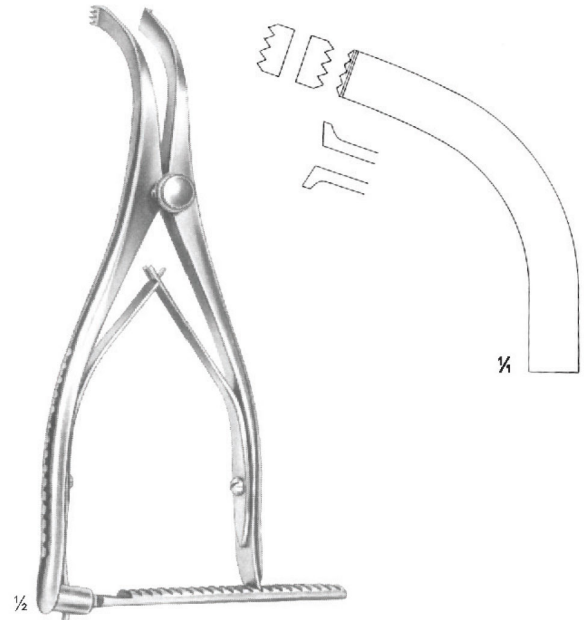

Fig. 2  
OI 18-5355-19





**CLOWARD**  
 OI 18-5356-16  
 16 cm/6 1/4"



**INGE**  
 OI 18-5357-16  
 16.5 cm/6 1/2"  
 Blade opening 35 mm

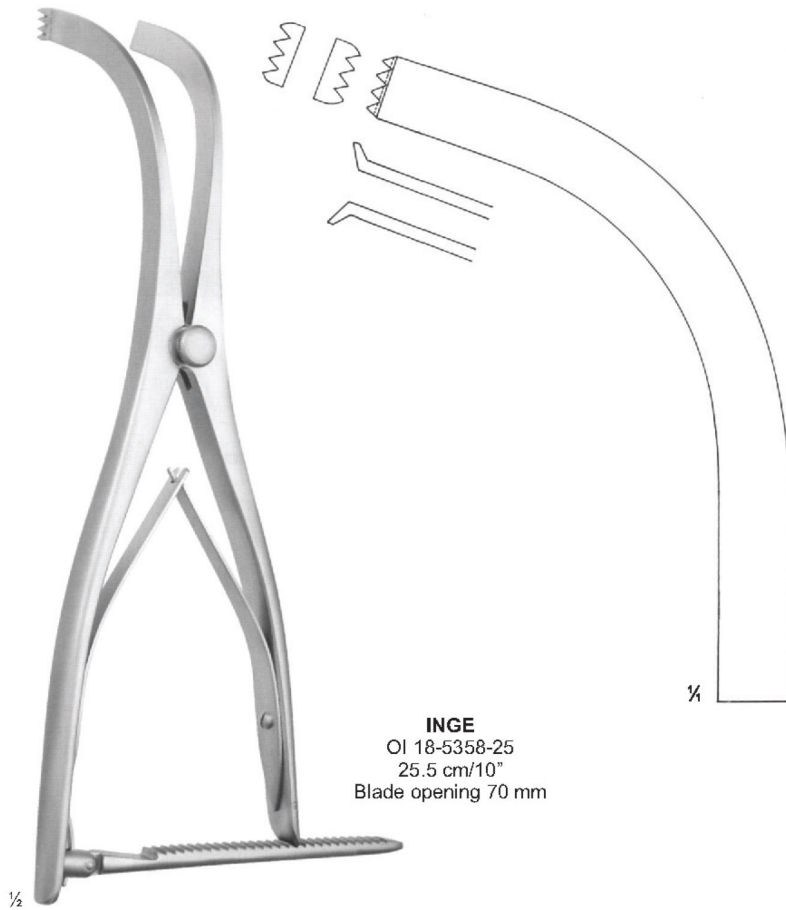

**INGE**  
 OI 18-5358-25  
 25.5 cm/10"  
 Blade opening 70 mm



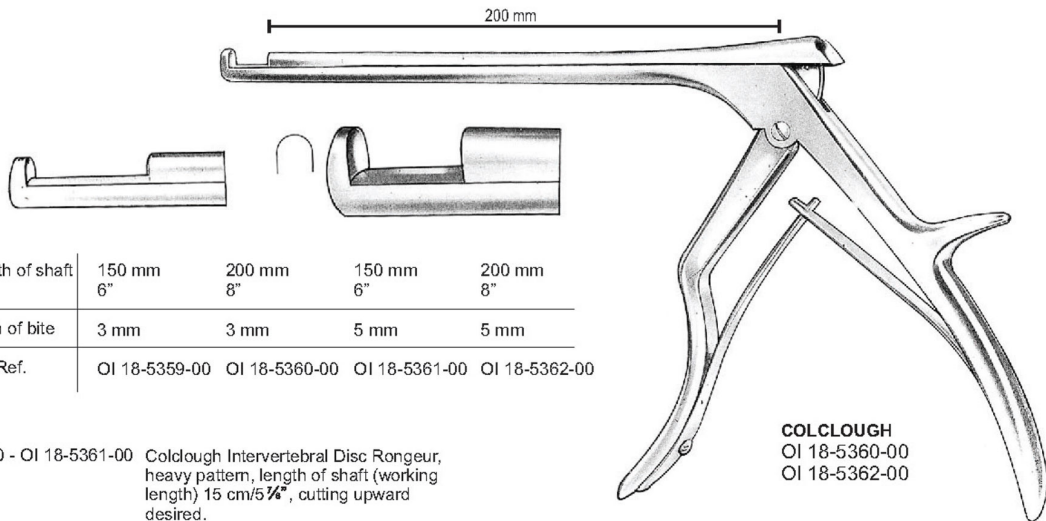
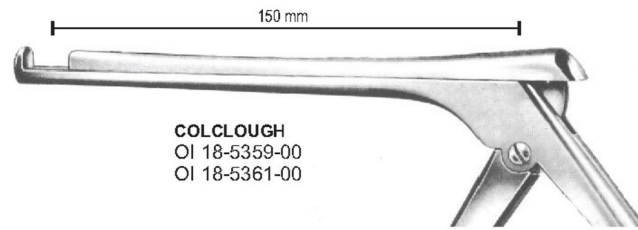

Length of shaft	150 mm 6"	200 mm 8"	150 mm 6"	200 mm 8"
Width of bite	3 mm	3 mm	5 mm	5 mm
Cat. Ref.	OI 18-5359-00	OI 18-5360-00	OI 18-5361-00	OI 18-5362-00

OI 18-5359-00 - OI 18-5361-00 Colclough Intervertebral Disc Rongeur, heavy pattern, length of shaft (working length) 15 cm/5 7/8", cutting upward desired.

OI 18-5360-00 - OI 18-5362-00 ditto, length of shaft (working length) 20 cm/7 7/8"

OI 18-5362-00 - OI 18-5363-00 ditto, length of shaft (working length) 15 cm/5 7/8", cutting downward

OI 18-5362-00 - OI 18-5362-00 ditto, length of shaft (working length) 20 cm/7 7/8"

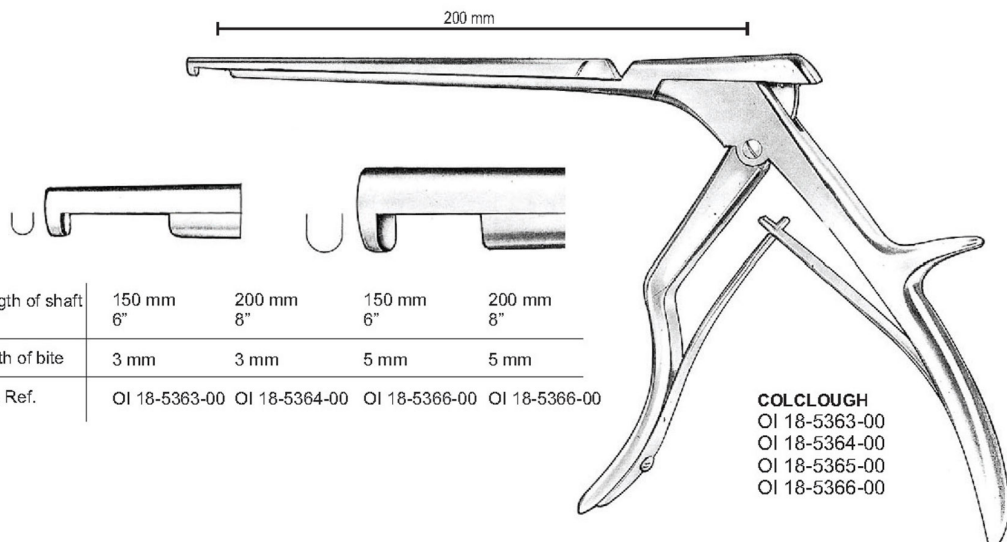
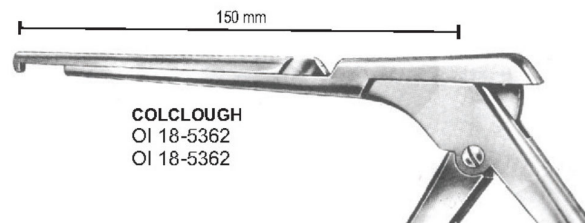

Length of shaft	150 mm 6"	200 mm 8"	150 mm 6"	200 mm 8"
Width of bite	3 mm	3 mm	5 mm	5 mm
Cat. Ref.	OI 18-5363-00	OI 18-5364-00	OI 18-5366-00	OI 18-5366-00



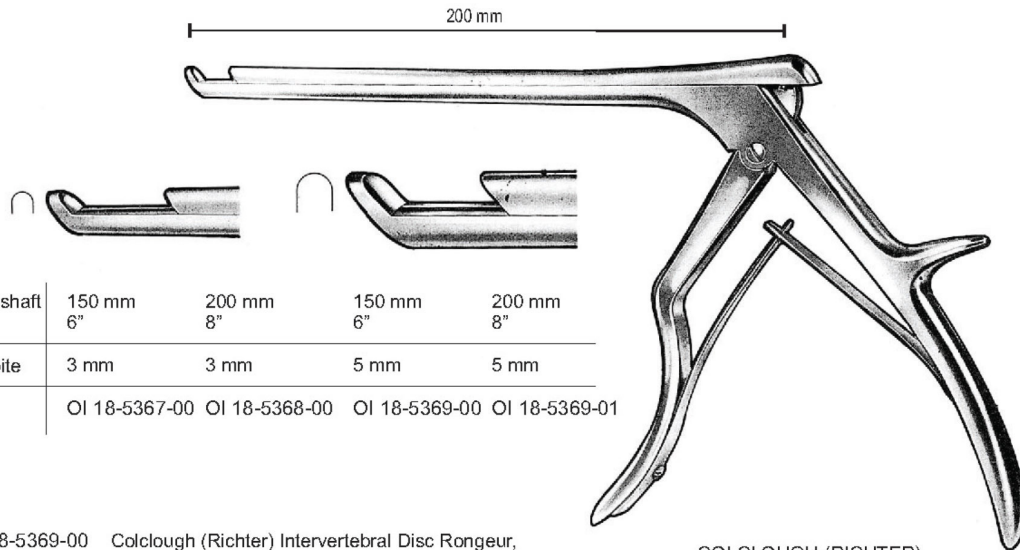
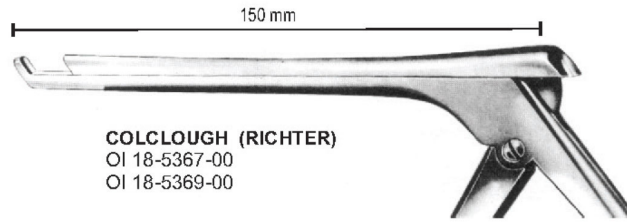

Length of shaft	150 mm 6"	200 mm 8"	150 mm 6"	200 mm 8"
Width of bite	3 mm	3 mm	5 mm	5 mm
Cat. Ref.	OI 18-5367-00	OI 18-5368-00	OI 18-5369-00	OI 18-5369-01

OI 18-5367-00 - OI 18-5369-00 Colclough (Richter) Intervertebral Disc Rongeur, heavy pattern, length of shaft (working length) 15 cm/6", cutting 40° forward

**COLCLOUGH (RICHTER)**  
OI 18-5368-00  
OI 18-5369-01

OI 18-5368-00 - OI 18-5369-01 ditto, length of shaft (working length) 20 cm/7 7/8"

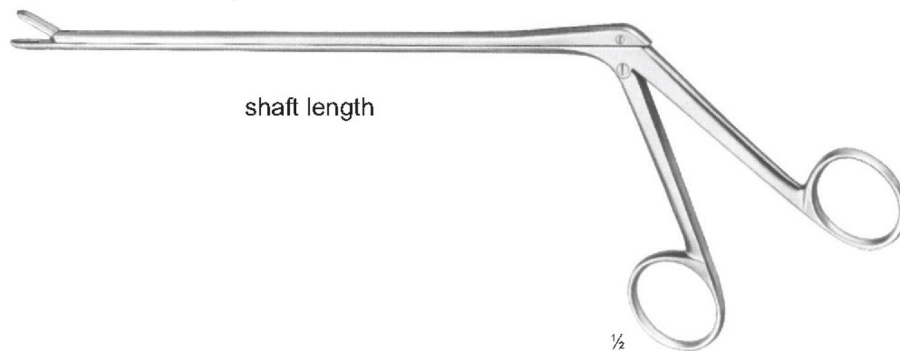

**CUSHING**  
straight

OI 18-5370-12 120 mm  
 OI 18-5370-15 150 mm  
 OI 18-5370-18 180 mm

**CUSHING**  
upwards

OI 18-5371-12 120 mm  
 OI 18-5371-15 150 mm  
 OI 18-5371-18 180 mm

**CUSHING**  
downwards

OI 18-5372-12 120 mm  
 OI 18-5372-15 150 mm  
 OI 18-5372-18 180 mm

**LOVE-GRUENWALD**  
straight

OI 18-5373-12 120 mm  
 OI 18-5373-15 150 mm  
 OI 18-5373-18 180 mm

**LOVE-GRUENWALD**  
upwards

OI 18-5374-12 120 mm  
 OI 18-5374-15 150 mm  
 OI 18-5374-18 180 mm

**LOVE-GRUENWALD**  
downwards

OI 18-5375-12 120 mm  
 OI 18-5375-15 150 mm  
 OI 18-5375-18 180 mm

**SPURLING**  
straight

OI 18-5376-12 120 mm  
 OI 18-5376-15 150 mm  
 OI 18-5376-18 180 mm

**SPURLING**  
upwards

OI 18-5377-12 120 mm  
 OI 18-5377-15 150 mm  
 OI 18-5377-18 180 mm

**SPURLING**  
downwards

OI 18-5378-12 120 mm  
 OI 18-5378-15 150 mm  
 OI 18-5378-18 180 mm

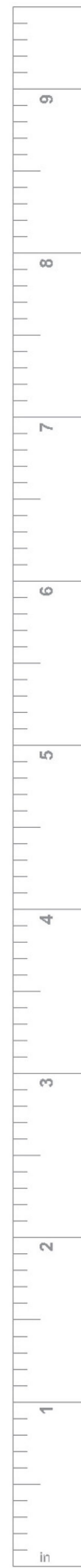

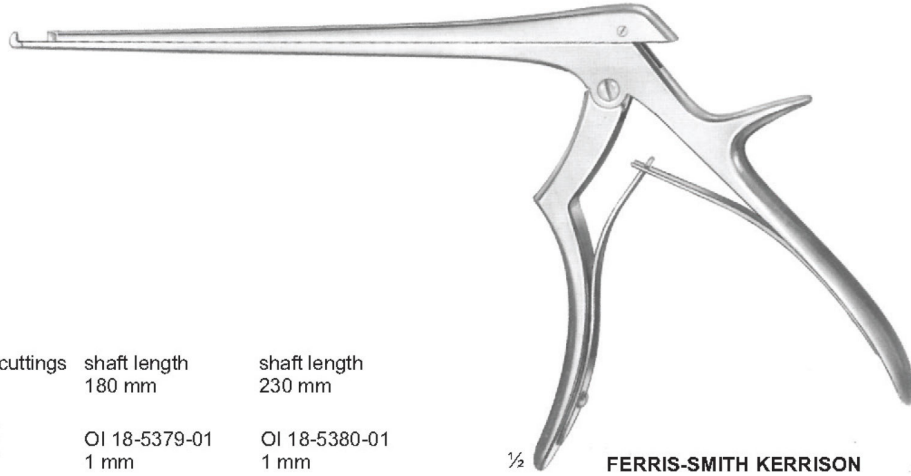

FERRIS-SMITH KERRISON

upwards cuttings	shaft length 180 mm	shaft length 230 mm
	OI 18-5379-01 1 mm	OI 18-5380-01 1 mm
	OI 18-5379-02 2 mm	OI 18-5380-02 2 mm
	OI 18-5379-03 3 mm	OI 18-5380-03 3 mm
	OI 18-5379-04 4 mm	OI 18-5380-04 4 mm
	OI 18-5379-05 5 mm	OI 18-5380-05 5 mm
	OI 18-5379-06 6 mm	OI 18-5380-06 6 mm

downwards cuttings	shaft length 180 mm
	OI 18-5383-03 3 mm

downwards cuttings	shaft length 180 mm	shaft length 230 mm
	OI 18-5381-01 1 mm	OI 18-5382-01 1 mm
	OI 18-5381-02 2 mm	OI 18-5382-02 2 mm
	OI 18-5383-03 3 mm	OI 18-5382-03 3 mm
	OI 18-5383-04 4 mm	OI 18-5382-04 4 mm
	OI 18-5383-05 5 mm	OI 18-5382-05 5 mm
	OI 18-5383-06 6 mm	OI 18-5382-06 6 mm

upwards cuttings	shaft length 180 mm	shaft length 230 mm
	OI 18-5384-01 1 mm	OI 18-5385-01 1 mm
	OI 18-5384-02 2 mm	OI 18-5385-02 2 mm
	OI 18-5384-03 3 mm	OI 18-5385-03 3 mm
	OI 18-5384-04 4 mm	OI 18-5385-04 4 mm
	OI 18-5384-05 5 mm	OI 18-5385-05 5 mm
	OI 18-5384-06 6 mm	OI 18-5385-06 6 mm





FERRIS-SMITH KERRISON

upwards cuttings	shaft length 180 mm	shaft length 230 mm	upwards cuttings	shaft length 180 mm	shaft length 230 mm
	OI 18-5386-1 1 mm	OI 18-5387-1 1 mm		OI 18-5388-1 1 mm	OI 18-5389-1 1 mm
	OI 18-5386-2 2 mm	OI 18-5387-2 2 mm		OI 18-5388-2 2 mm	OI 18-5389-2 2 mm
	OI 18-5386-3 3 mm	OI 18-5387-3 3 mm		OI 18-5388-3 3 mm	OI 18-5389-3 3 mm
	OI 18-5386-4 4 mm	OI 18-5387-4 4 mm		OI 18-5388-4 4 mm	OI 18-5389-4 4 mm
	OI 18-5386-5 5 mm	OI 18-5387-5 5 mm		OI 18-5388-5 5 mm	OI 18-5389-5 5 mm
	OI 18-5386-6 6 mm	OI 18-5387-6 6 mm		OI 18-5388-6 6 mm	OI 18-5389-6 6 mm





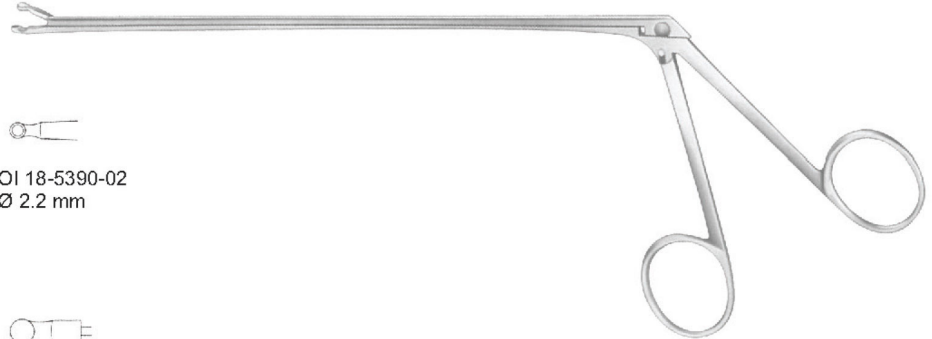

OI 18-5390-02  
Ø 2.2 mm



OI 18-5390-03  
Ø 3.5 mm

**YASARGIL**

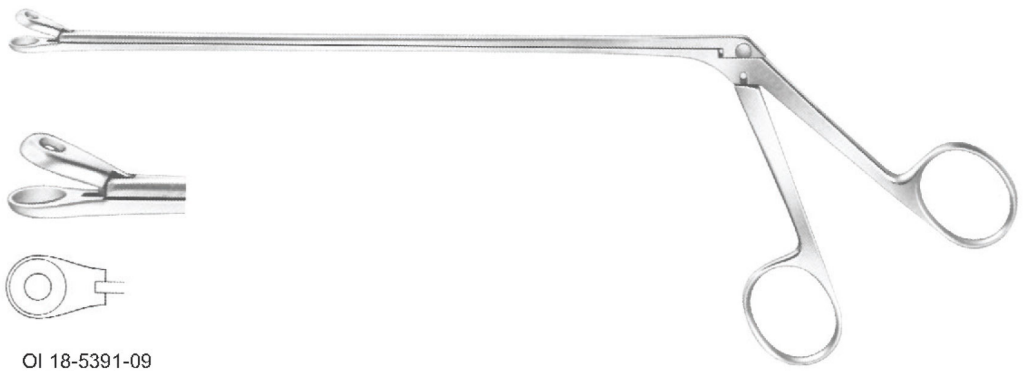

OI 18-5391-09  
Ø 9.0 mm

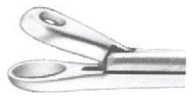

**LANDOLT**  
Tumor grasping forceps, blunt

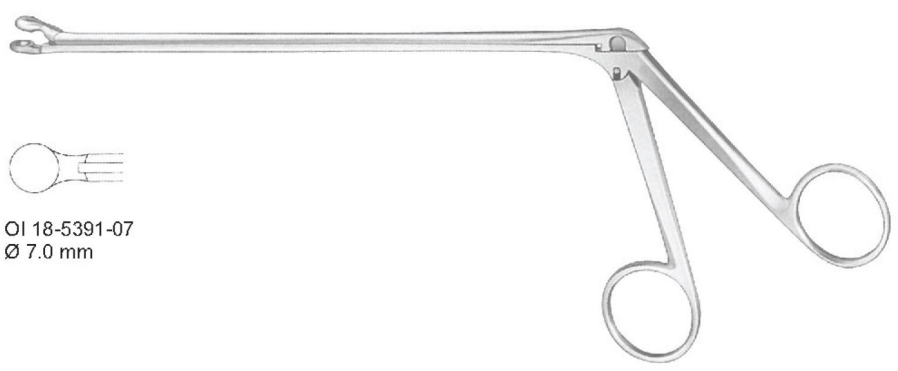

OI 18-5391-07  
Ø 7.0 mm

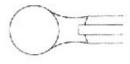

**OLDBERG**