

EN Rhinology

DE Rhinologie

ES Rinología

Page 541 to 574



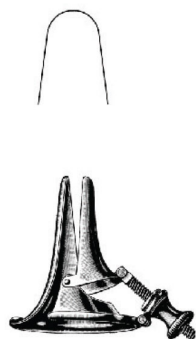

VACHER
OI 22-6601-00



VOLTOLINI



OI 22-6602-01



OI 22-6602-02



OI 22-6602-03



GOLDSMITH (Thudichum) OI 22-6603-00 set / 7



OI 22-6603-01



OI 22-6603-02



OI 22-6603-03



Fig. 4

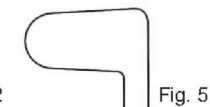

OI 22-6603-05



Fig. 6

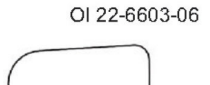
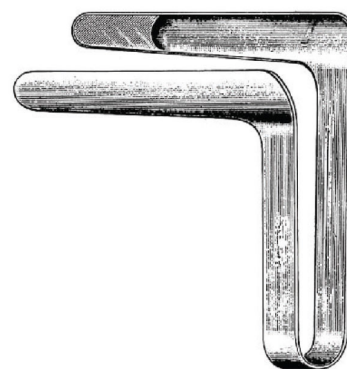
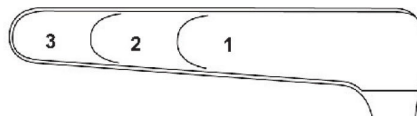

Fig. 7

OI 22-6603-07



ST. CLAIR THOMSON

OI 22-6604-00 set / 3

OI 22-6604-01 35mm Fig. 1

OI 22-6604-02 50mm Fig. 2

OI 22-6604-03 75mm Fig. 3

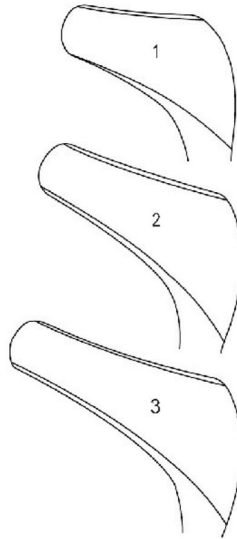

HARTMANN-HALLE
 15.0cm
 OI 22-6605-01 Fig. 1
 OI 22-6605-02 Fig. 2
 OI 22-6605-03 Fig. 3

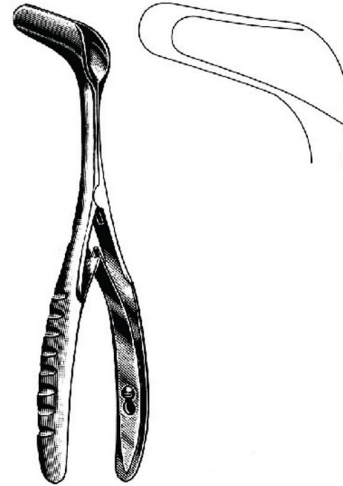

SCHWARZ
 OI 22-6606-14
 14.0cm



VIENNA
 14.5cm
 OI 22-6607-01 (infant)
 OI 22-6607-02 (child)
 OI 22-6607-03 (adult)
 OI 22-6607-04 (sheet metal)



MOD WIEN
 OI 22-6608-14
 14.5cm





Pediatrics

OI 22-6609-13
13.0cm



OI 22-6610-13
13.0cm



TIECK-HALLE
13.5cm
OI 22-6611-01
OI 22-6611-02

Fig.1

2



TIECK-HALLE
OI 22-6612-13
13.5cm



KILLIAN
13.0cm
OI 22-6613-35
OI 22-6613-50
OI 22-6613-75
OI 22-6613-90

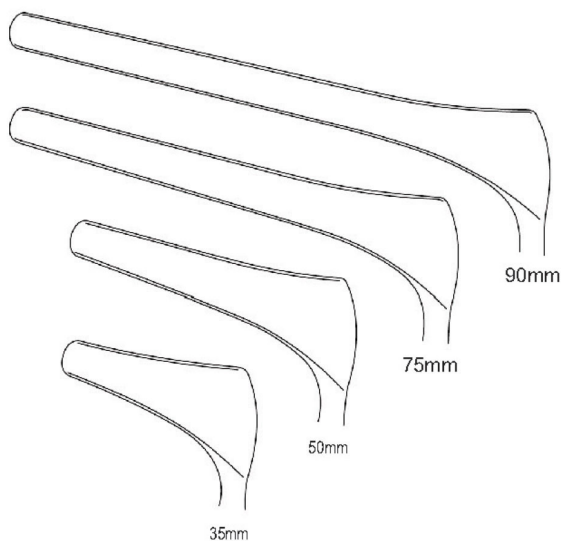

KILLIAN (with side screw)
13.0cm
OI 22-6614-35
OI 22-6614-50
OI 22-6614-75
OI 22-6614-90



COTTLE
 15.0cm
 OI 22-6615-35
 OI 22-6615-50
 OI 22-6615-75
 OI 22-6615-90

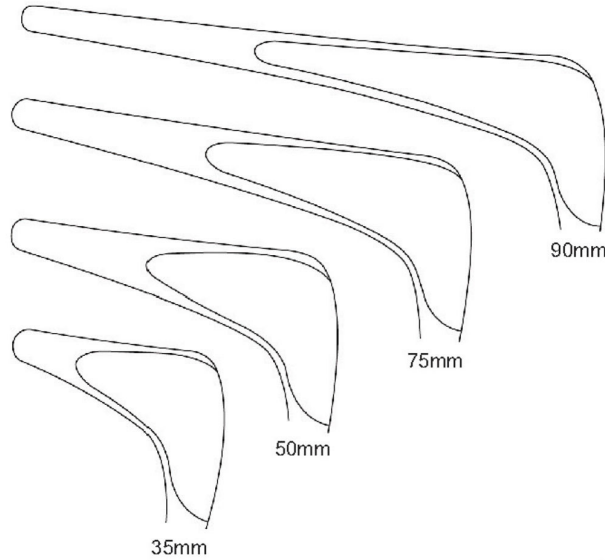

COTTLE (with side screw)
 15.0cm
 OI 22-6616-35
 OI 22-6616-50
 OI 22-6616-75
 OI 22-6616-90



COTTLE
 (dull black chromium plated)
 14.0cm

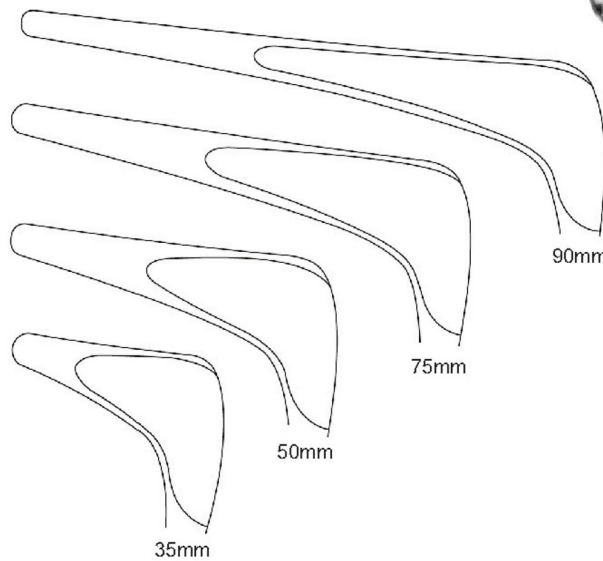

OI 22-6617-35
 OI 22-6617-50
 OI 22-6617-75
 OI 22-6617-90

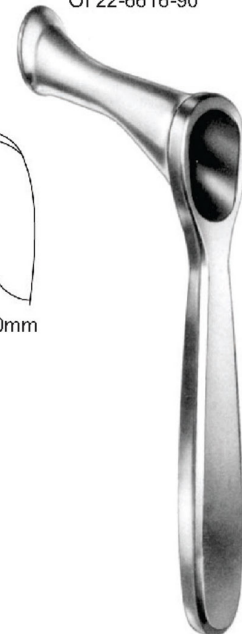

YANKAUER
 OI 22-6618-19
 19.0cm



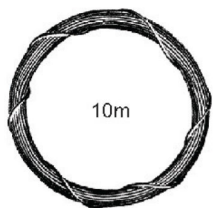

10m

OI 22-6619-03 0.3mm Ø
OI 22-6619-04 0.4mm Ø



OI 22-6620-02 0.2mm Ø
OI 22-6620-03 0.3mm Ø



KRAUSE
OI 22-6621-26
26.0cm

KRAUSE-VOSS
OI 22-6622-26
26.0cm

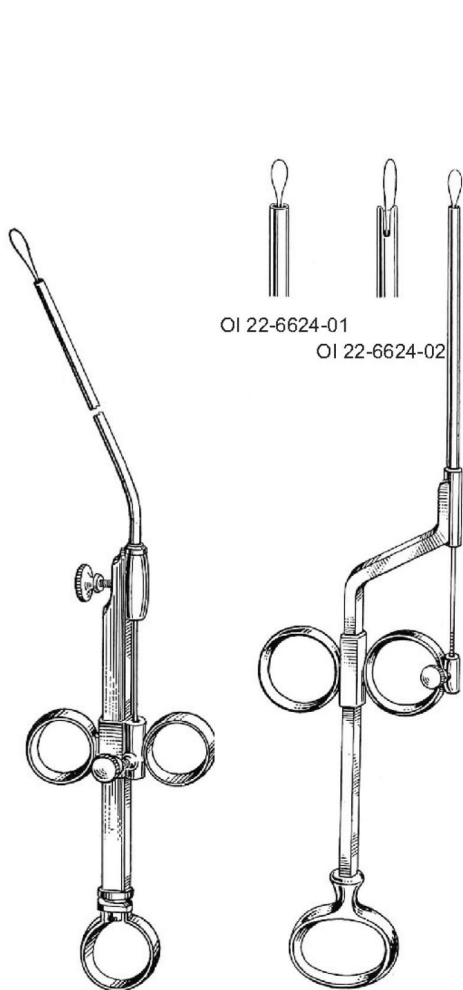

OI 22-6624-01
OI 22-6624-02

KRAUSE
OI 22-6623-00

GLEGG

Nasal Polypus and Septum Compression Forceps
 Polypenzangen, Septumzange
 Pinzas para polipos, pinzas para el tabique nasal

● EN
 ● DE
 ● ES

RHINOLOGY



KILLIAN
 OI 22-6625-17
 17.0cm



LITTAUER
 OI 22-6626-18
 18.0cm

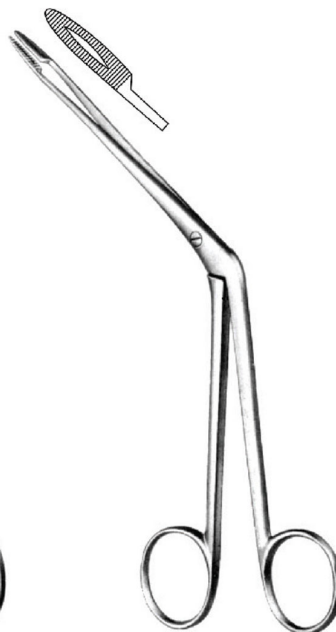

HARTMANN
 OI 22-6627-20
 20.0cm



QUIRE
 OI 22-6628-12
 12.0cm

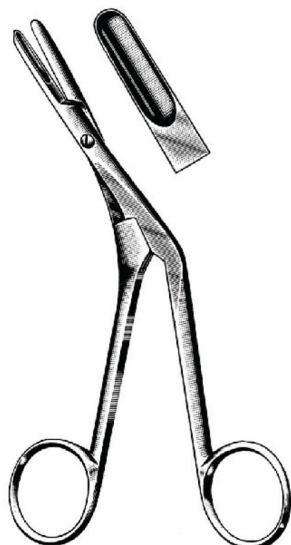

GRAIG
 OI 22-6629-18
 18.0cm



OI 22-6630-01 OI 22-6630-02

18.0cm

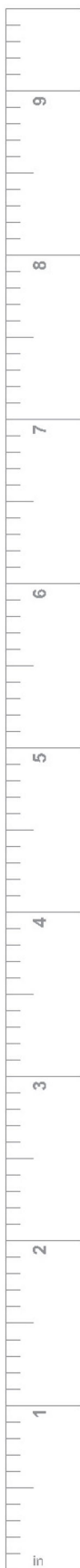



KNIGHT
OI 22-6631-18
18.0cm

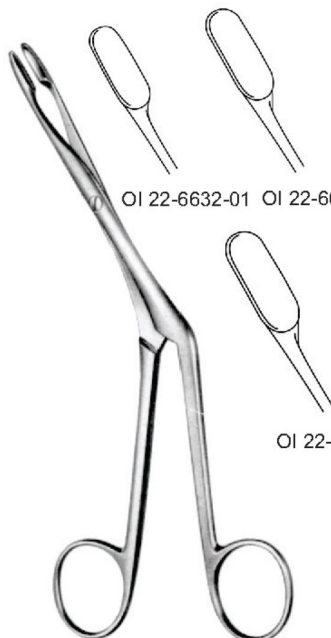

HEYMANN
18.0cm

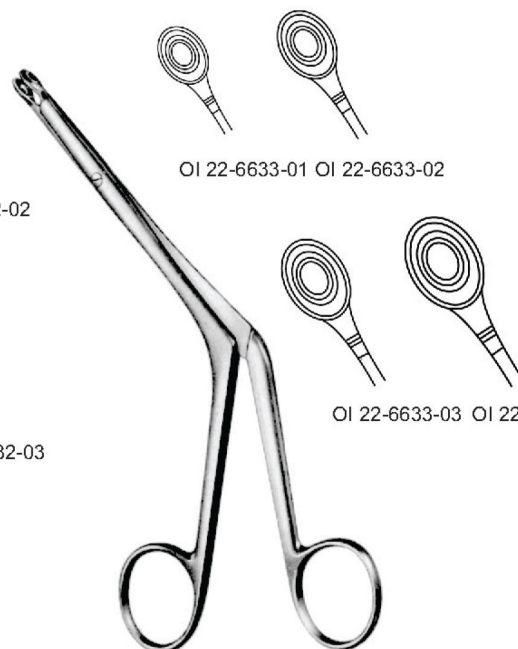

BRUENINGS
19.0cm

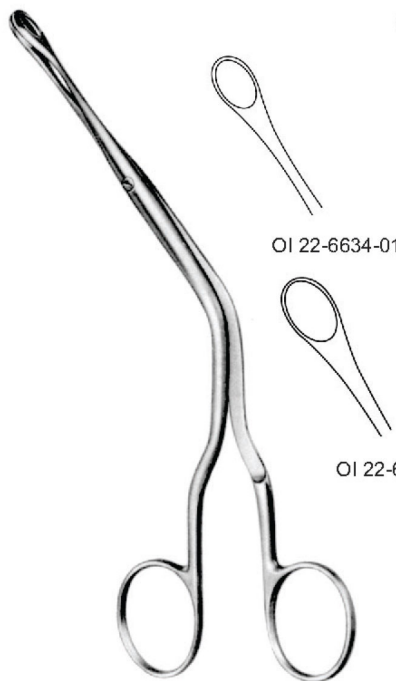

LUC
20.0cm

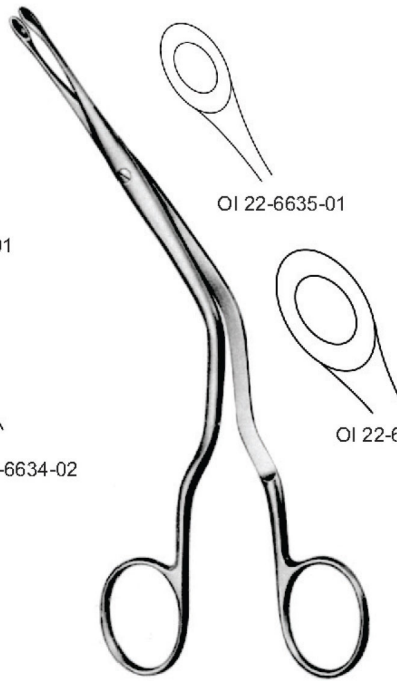

LUC
20.0cm

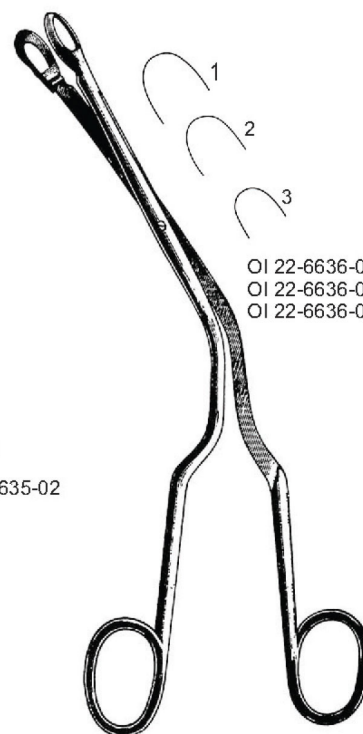

LUC
20.0cm

OI 22-6633-01 OI 22-6633-02
 OI 22-6632-01 OI 22-6632-02
 OI 22-6632-03
 OI 22-6633-03 OI 22-6633-04
 OI 22-6634-01
 OI 22-6634-02
 OI 22-6635-01
 OI 22-6635-02
 OI 22-6636-01 Fig. 1
 OI 22-6636-02 Fig. 2
 OI 22-6636-03 Fig. 3

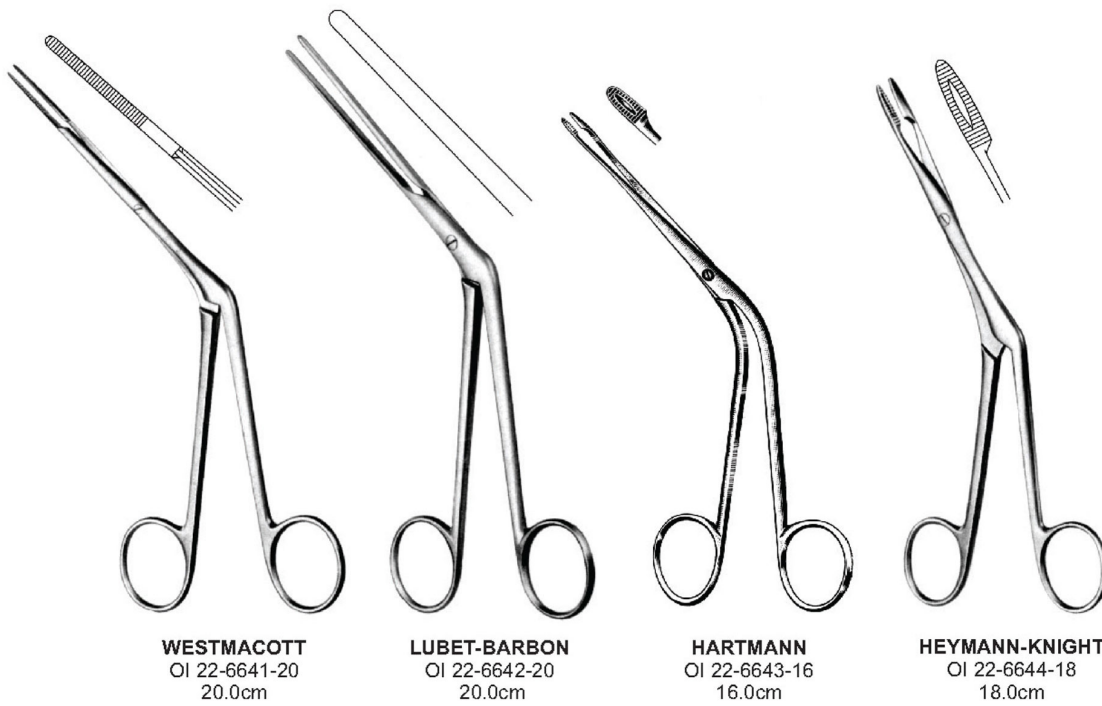
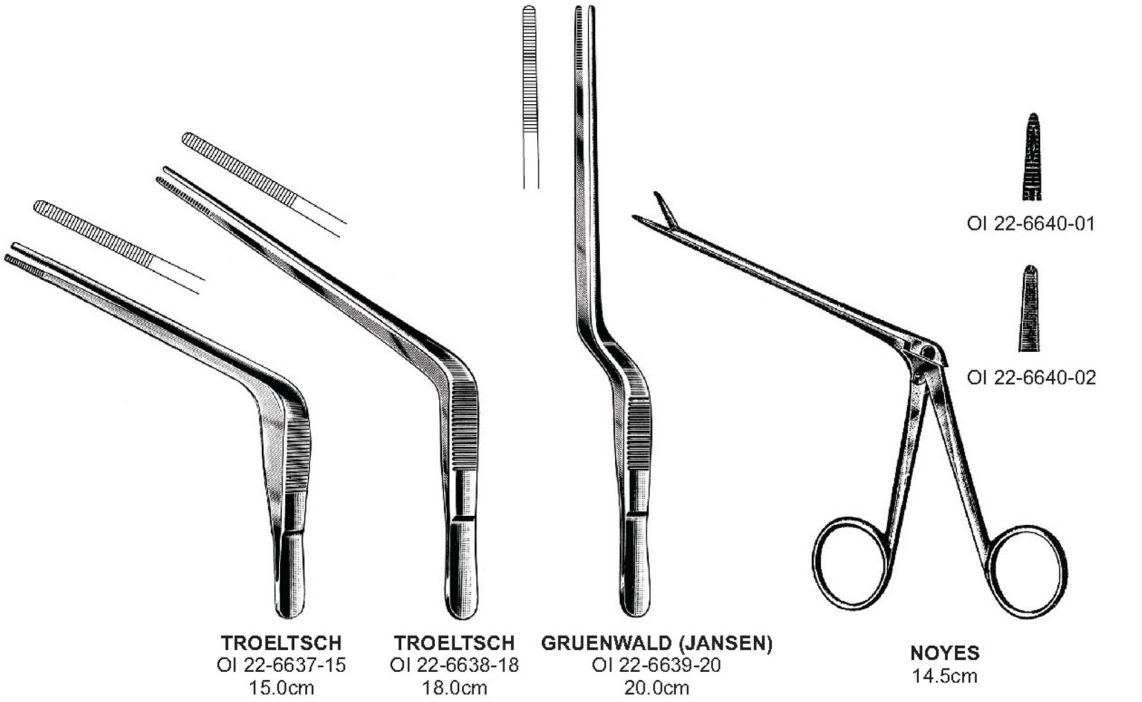

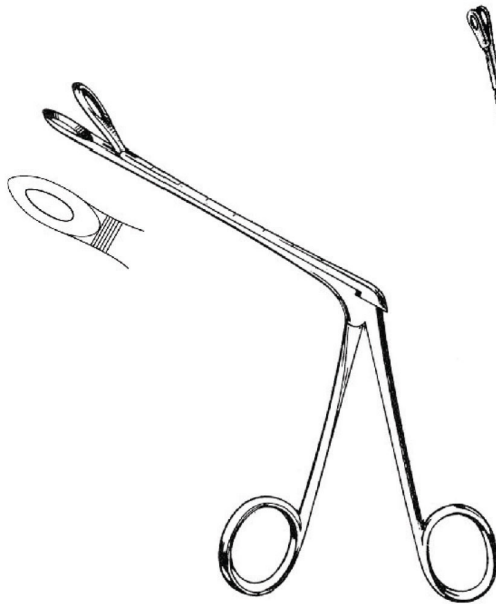

HENCKEL
OI 22-6645-20
20.0cm

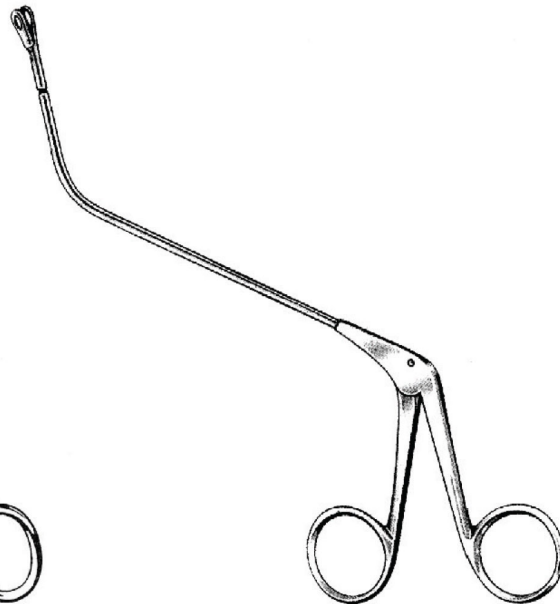

JATHO
OI 22-6646-15

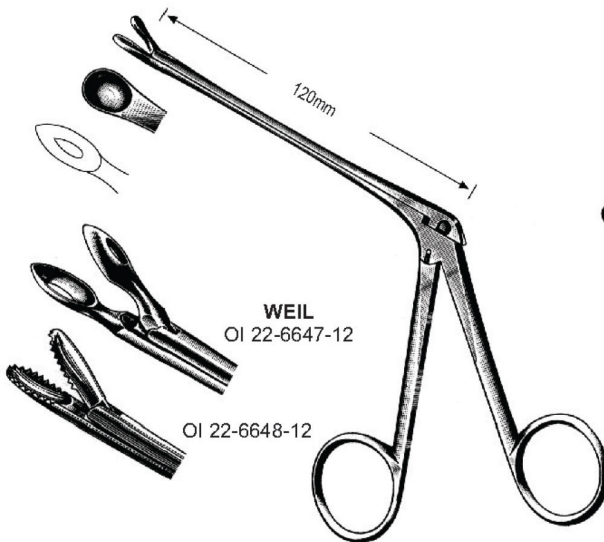

WEIL
OI 22-6647-12

OI 22-6648-12

WATSON-WILLIAMS
OI 22-6648-19
19.0cm

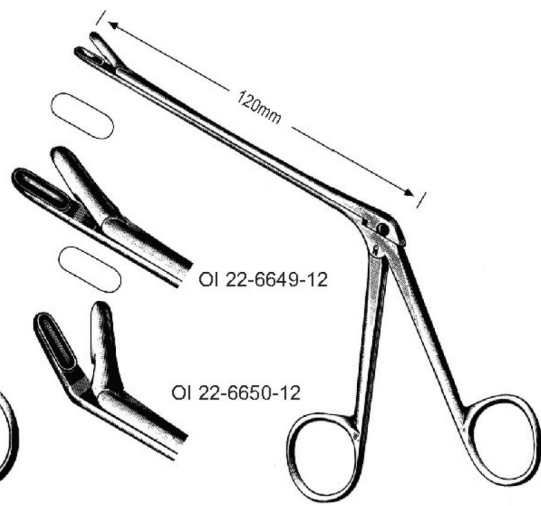

OI 22-6649-12

OI 22-6650-12

TAKAHASHI
19.0cm



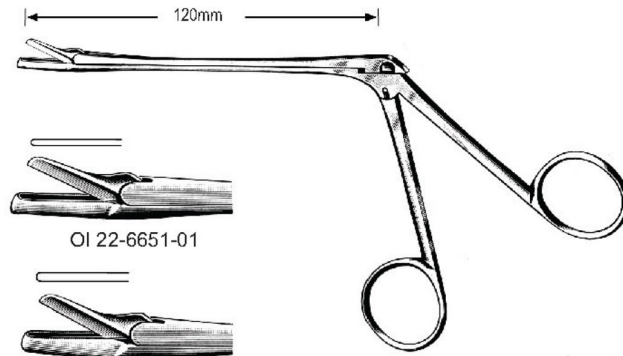

STRUYCKEN
 19.0cm

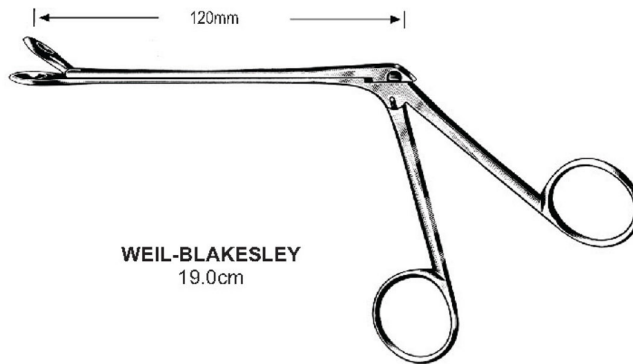

WEIL-BLAKESLEY
 19.0cm

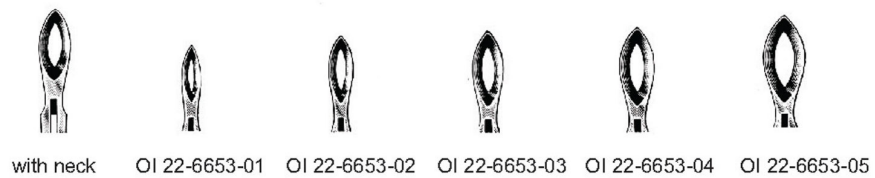
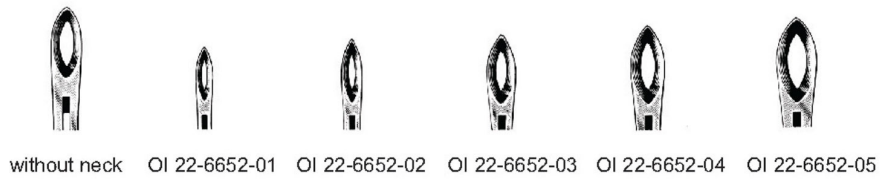

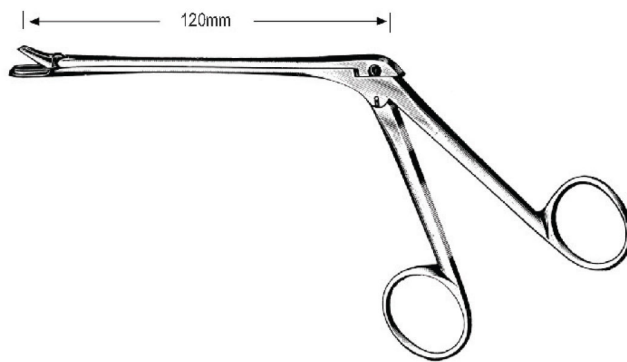

HAJEK
19.0cm

OI 22-6654-12

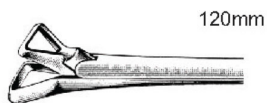

SCHMEDEN
19.0cm

OI 22-6655-12



HARTMANN
19.0cm

OI 22-6656-01 5mm OI 22-6656-02 7mm
 OI 22-6656-03 9mm OI 22-6656-04 11mm

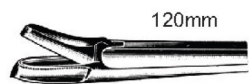

MYLES
19.0 cm

OI 22-6657-01 2.2mm

OI 22-6657-02 2.6mm

OI 22-6658-01

OI 22-6658-02

OI 22-6657-03 3mm

OI 22-6657-04 3.4mm

OI 22-6658-03

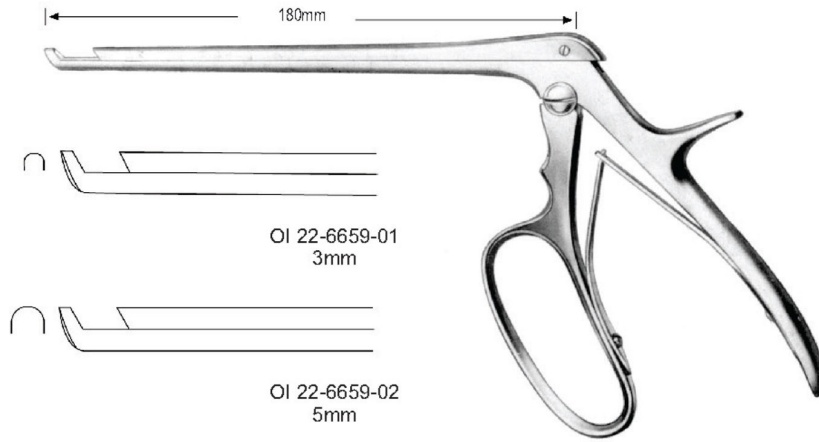

**FERRIS-SMITH-KERRISON
 (CLOWARD HARPER)**

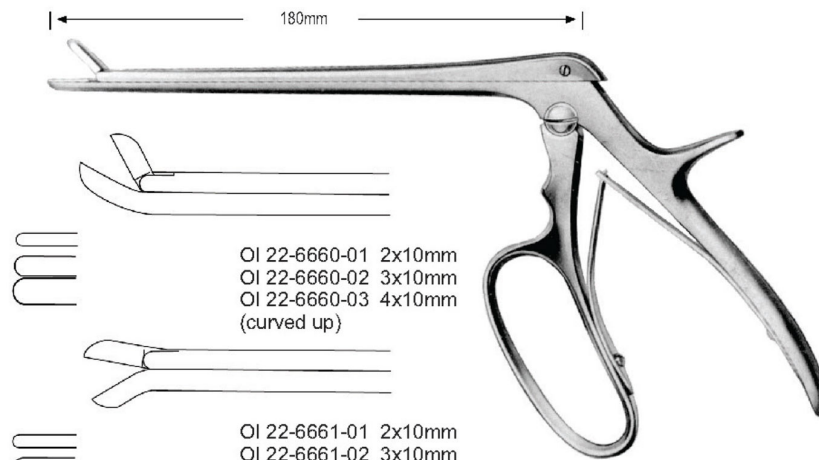

FERRIS-SMITH-CUSHING

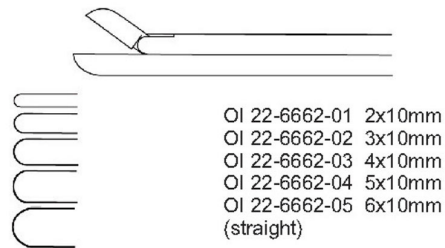

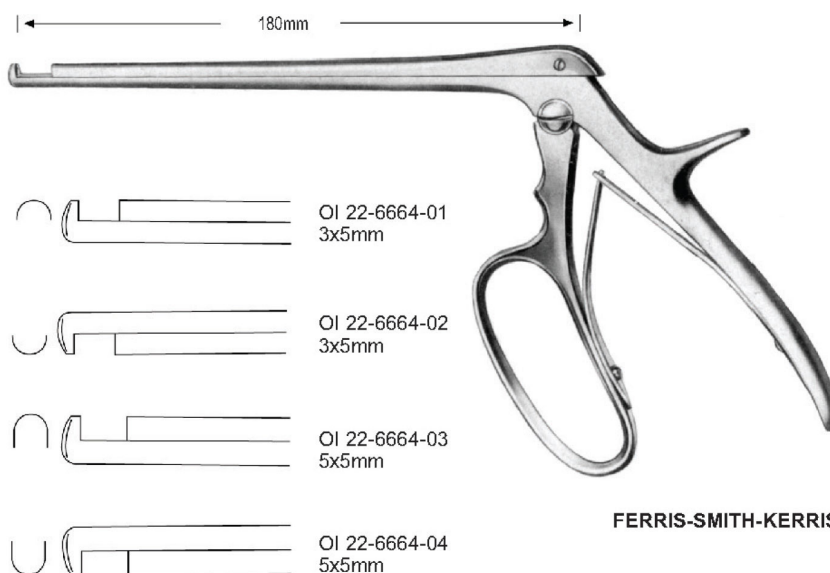
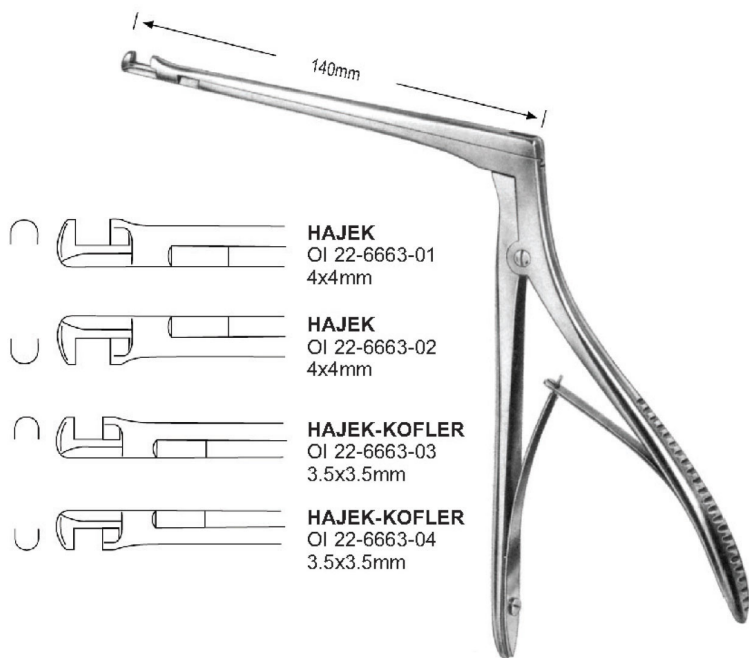

Sphenoid Punches and Rongeur Forceps

Keibeinstanzen, Meißelzangen



Pinzas cortantes para seno esfesoidal, pinzas-gubias

EN

DE

ES

RHINOLOGY

- 4x4mm  OI 22-6665-01
4mm
- 5x5mm  OI 22-6665-02
5mm
- 6x6mm  OI 22-6665-03
6mm



KERRISON
20.0cm



HAJEK-CLAUS
OI 22-6666-20
20.0cm



CITELLI
 OI 22-6667-10 1mm
 OI 22-6667-25 2.5mm
 OI 22-6667-30 3mm
 OI 22-6667-35 3.5mm
 OI 22-6667-40 4mm



BEYER
OI 22-6668-19
2mm



BEYER
OI 22-6669-19
1mm



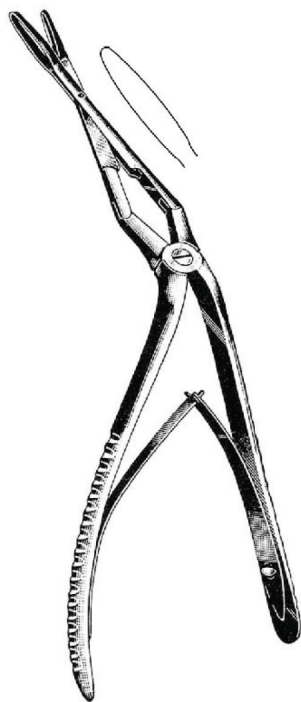

JANSEN-STRUYCKEN
OI 22-6670-19
19.0cm



MIDDLETON-JANSEN
OI 22-6671-19
19.0cm



MIDDLETON-JANSEN
OI 22-6672-19
19.0cm



CAPLAN
OI 22-6673-20
20.0cm



KILLIAN
OI 22-6674-21
21.0cm



RUBIN
OI 22-6675-21
21.0cm



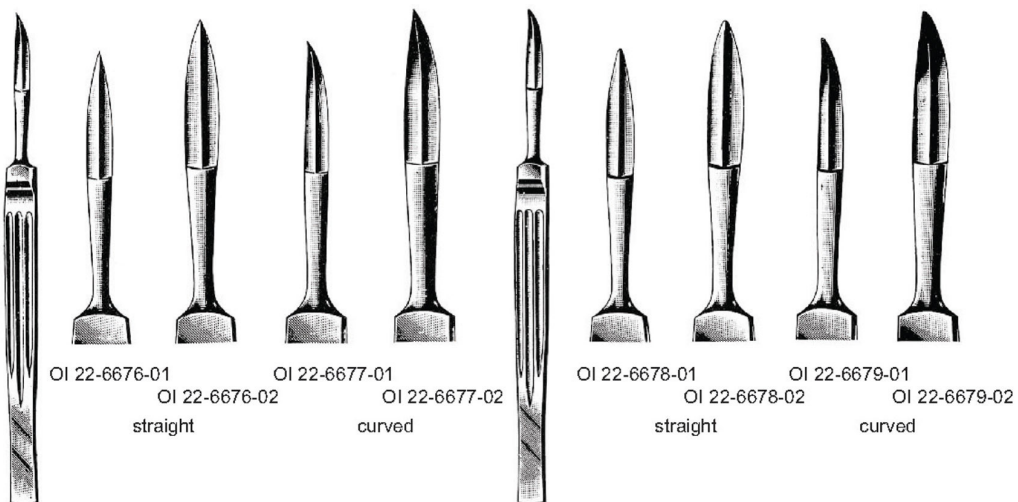

JOSEPH (sharp)
15.0cm

JOSEPH (blunt)
15.0cm

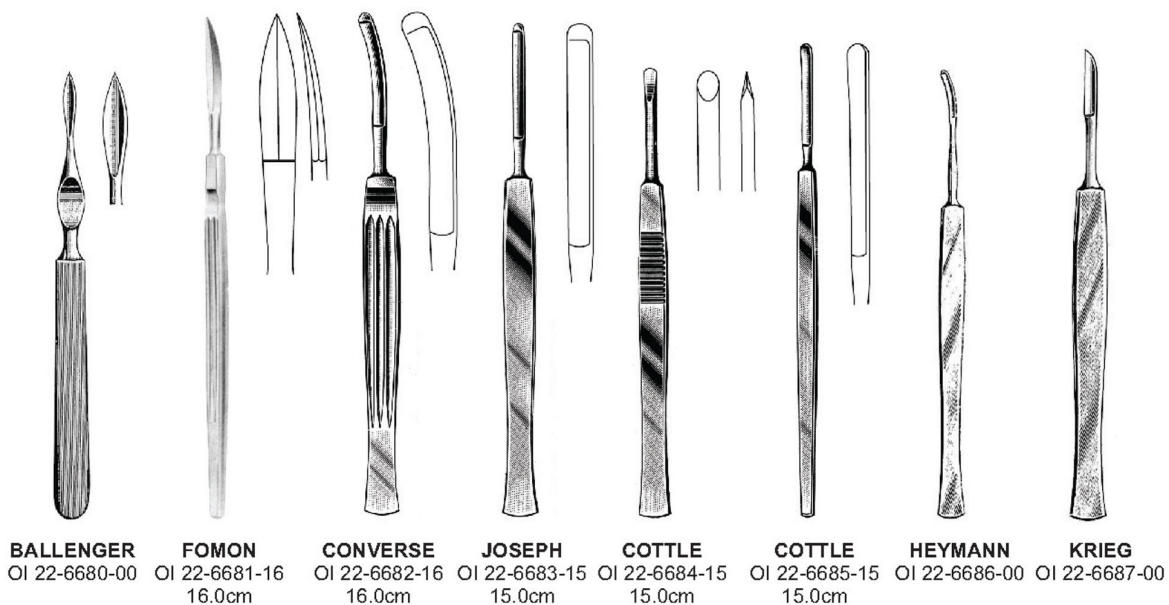

BALLENGER
OI 22-6680-00

FOMON
OI 22-6681-16
16.0cm

CONVERSE
OI 22-6682-16
16.0cm

JOSEPH
OI 22-6683-15
15.0cm

COTTLE
OI 22-6684-15
15.0cm

COTTLE
OI 22-6685-15
15.0cm

HEYMANN
OI 22-6686-00

KRIEG
OI 22-6687-00





BALLENGER
20.0cm



OI 22-6688-03
3mm



OI 22-6688-04
4mm



OI 22-6688-05
5mm



BALLENGER
20.0cm



OI 22-6689-03
3mm



OI 22-6689-04
4mm



OI 22-6689-05
5mm



BRUENINGS
OI 22-6690-16
16.5cm



FREER
OI 22-6691-00



FREER
OI 22-6692-15
15.0cm

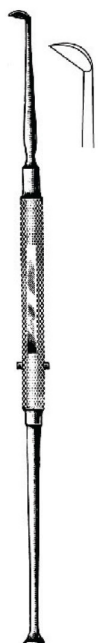

FREER
OI 22-6693-19
19.0cm



FREER
OI 22-6694-19
19.0cm



FREER
OI 22-6695-19
19.0cm



FREER
OI 22-6696-19
19.0cm

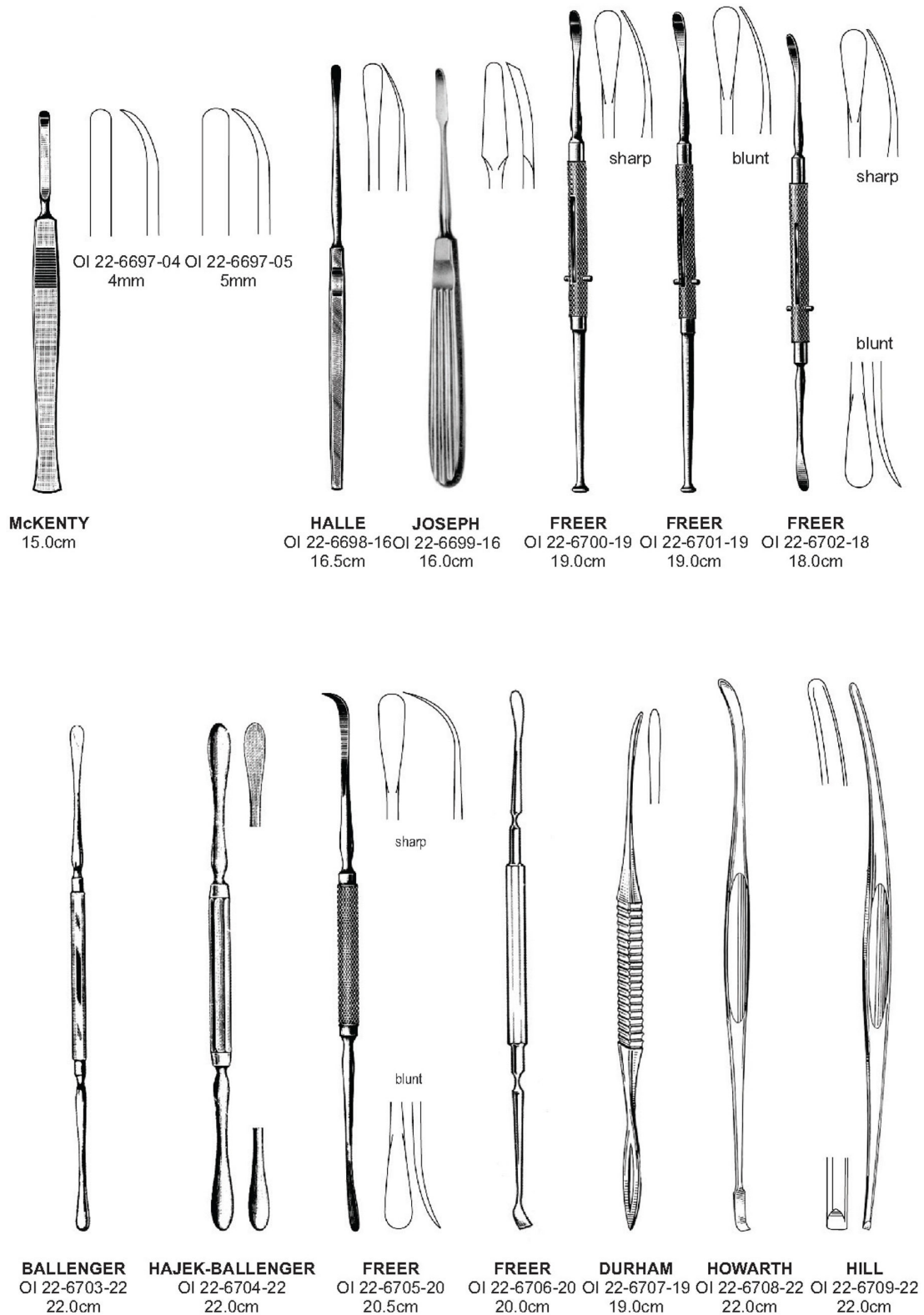

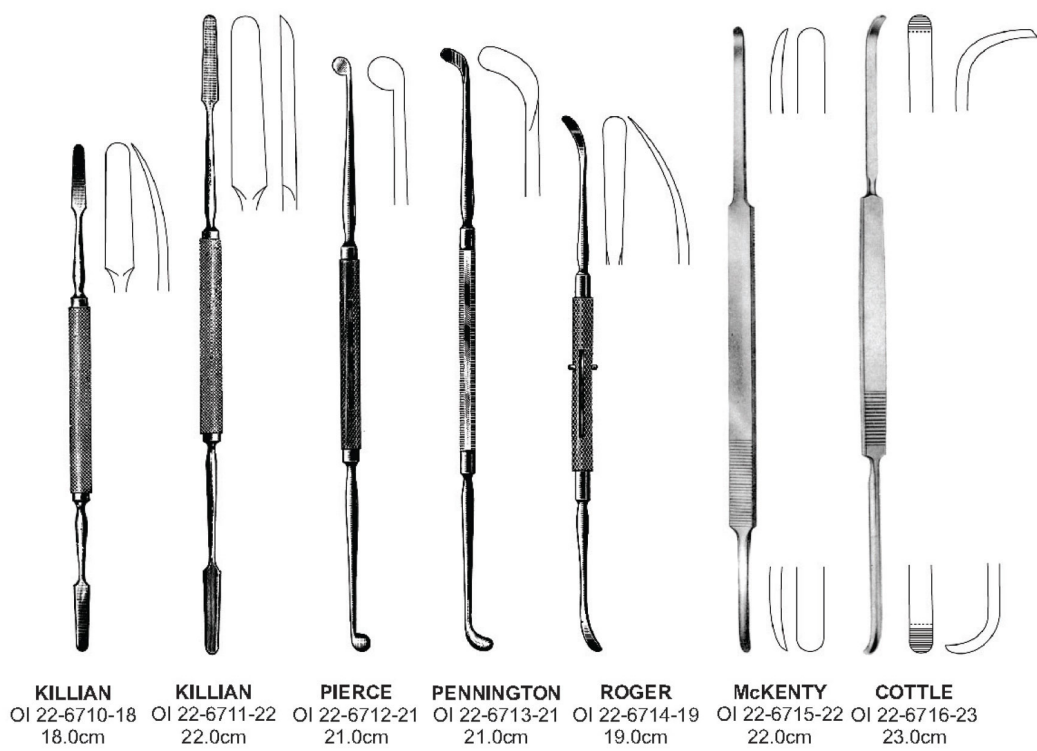

| | | | | | | |
|---|---|--|--|---|---|--|
| KILLIAN OI 22-6710-18 18.0cm | KILLIAN OI 22-6711-22 22.0cm | PIERCE OI 22-6712-21 21.0cm | PENNINGTON OI 22-6713-21 21.0cm | ROGER OI 22-6714-19 19.0cm | McKENTY OI 22-6715-22 22.0cm | COTTLE OI 22-6716-23 23.0cm |
|---|---|--|--|---|---|--|

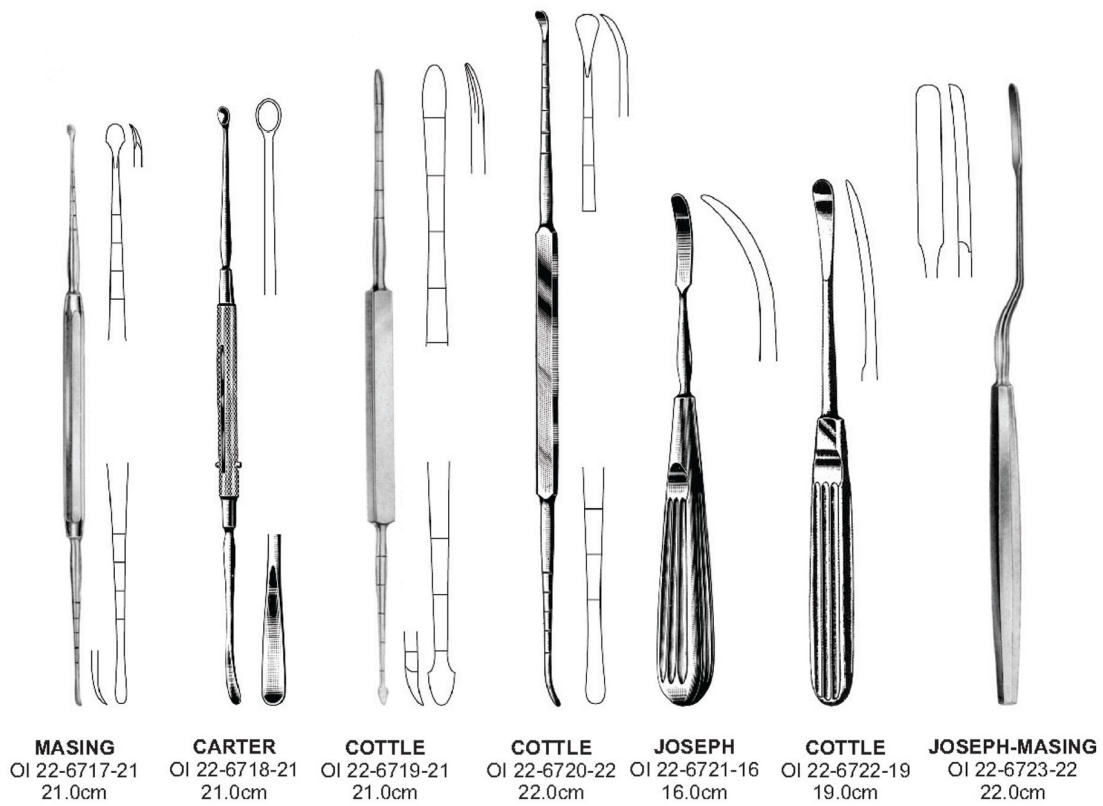



KILLIAN
OI 22-6724-17
17.0cm



KILLIAN-CLAUS
OI 22-6725-17
17.0cm

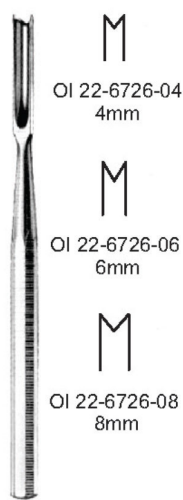

BALLENGER



FREER
OI 22-6727-15
15.0cm



WEST
OI 22-6728-16
16.0cm



WEST
OI 22-6729-16
16.0cm



FREER
OI 22-6730-16



FREER
OI 22-6731-16

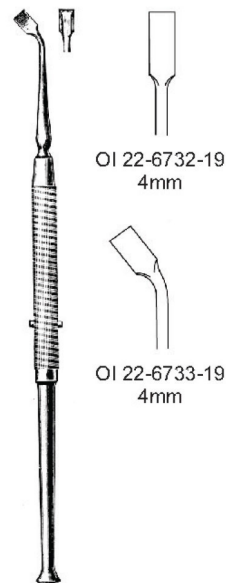

FREER



OI 22-6734-17

OI 22-6735-17

JOSEPH
17.0cm

JOSEPH
19.0cm

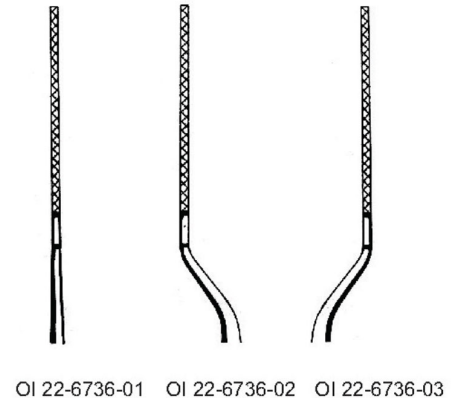

OI 22-6736-01

OI 22-6736-02

OI 22-6736-03



SILVER
OI 22-6737-18
18.0cm

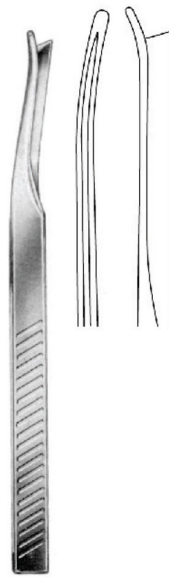

SILVER
OI 22-6738-18
18.0cm

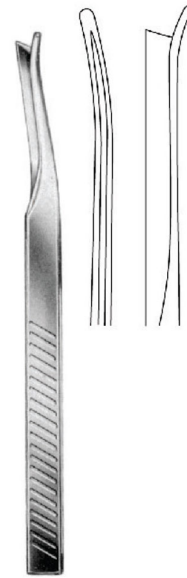

SILVER
OI 22-6739-18
18.0cm



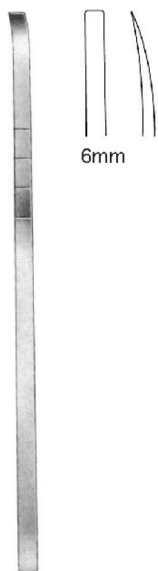

6mm

COTTLE
OI 22-6740-18
18.0cm

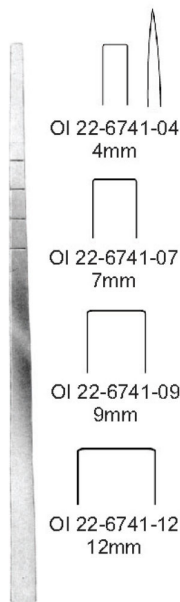

OI 22-6741-04
4mm

OI 22-6741-07
7mm

OI 22-6741-09
9mm

OI 22-6741-12
12mm

COTTLE
18.0cm

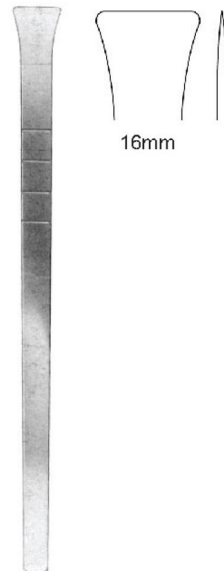

16mm

COTTLE
OI 22-6742-18
18.0cm



6mm

COTTLE
OI 22-6743-18
18.0cm

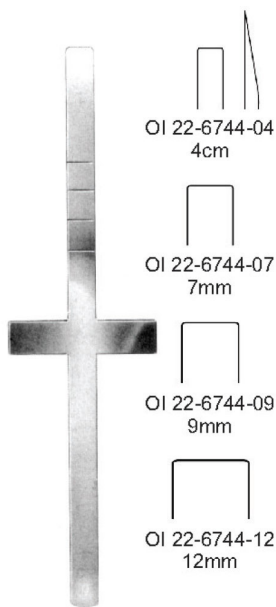

OI 22-6744-04
4cm

OI 22-6744-07
7mm

OI 22-6744-09
9mm

OI 22-6744-12
12mm

COTTLE
18.0cm



16mm

COTTLE
OI 22-6745-18
18.0cm

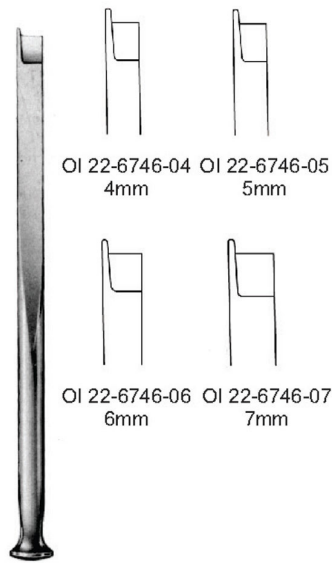

FOMON
17.0cm

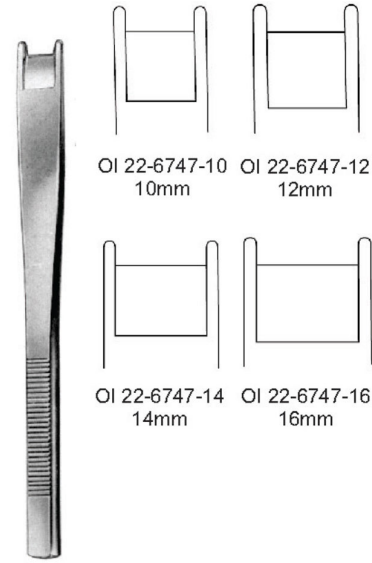

CINELLI
16.0cm

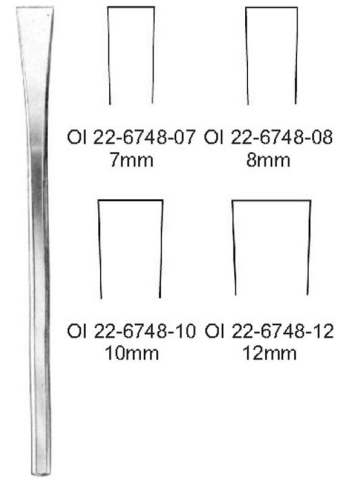

SHEEHAN
17.0cm

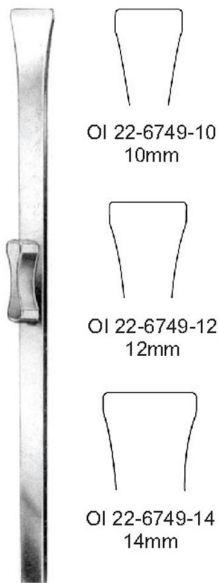

RUBIN
18.0cm

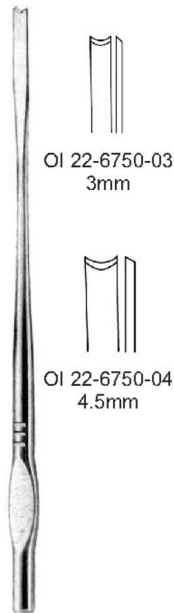

WALTER
19.0cm

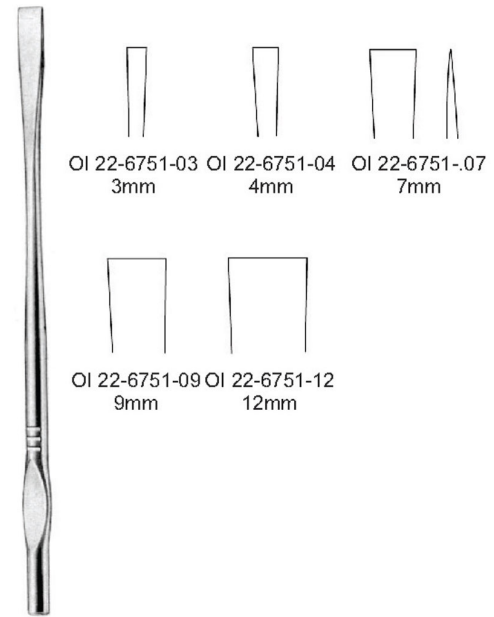

WALTER
19.0cm



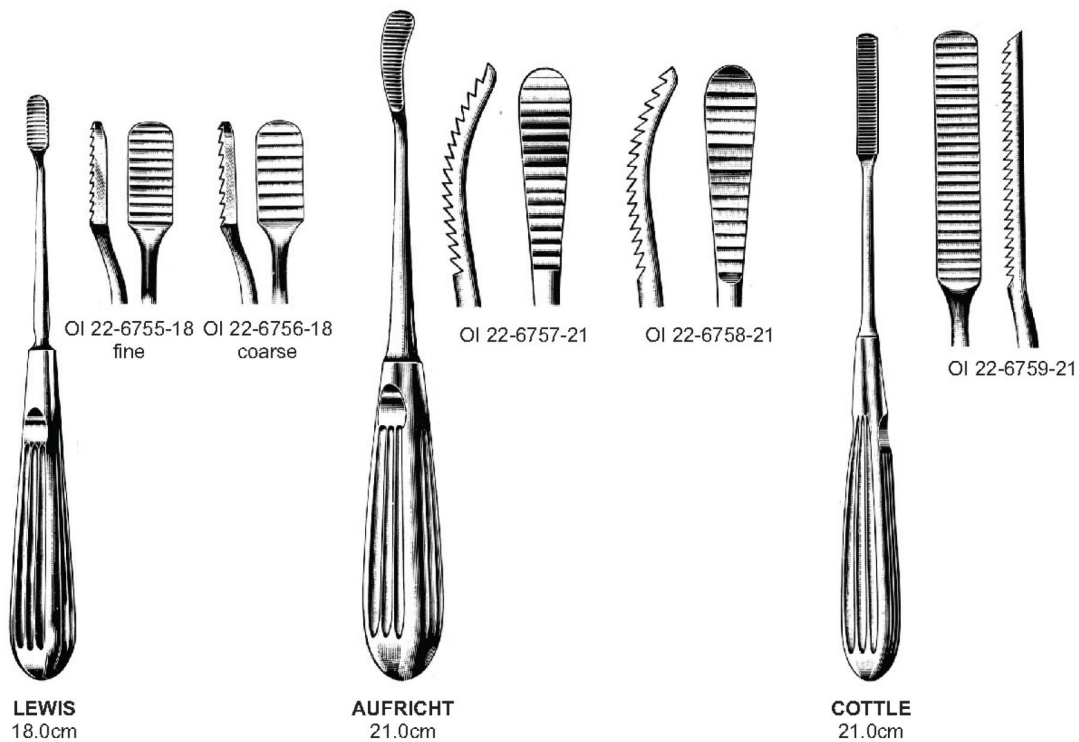
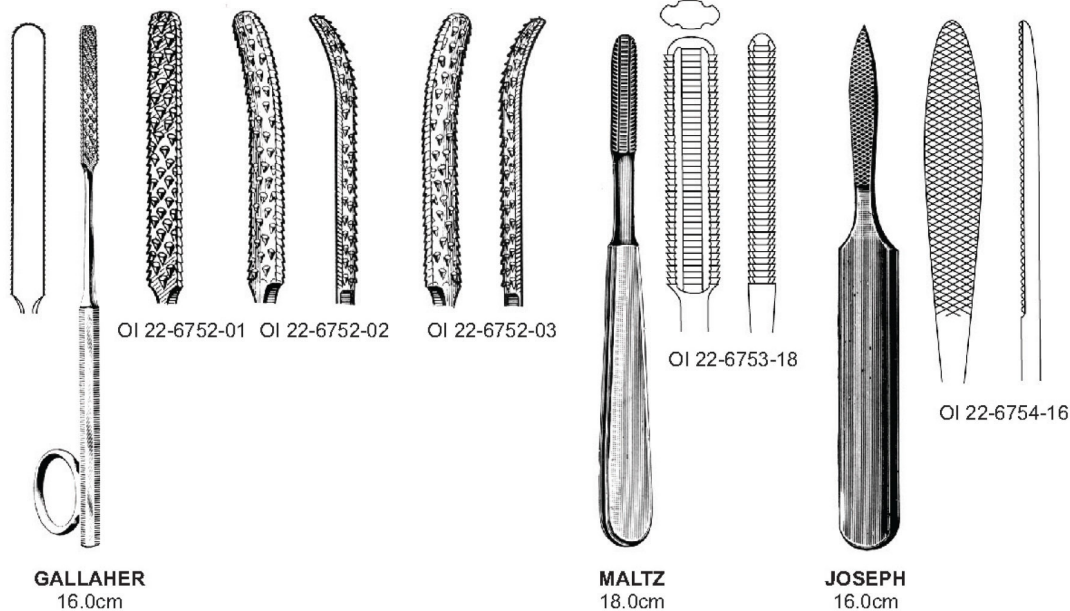



WIENER
18.0cm

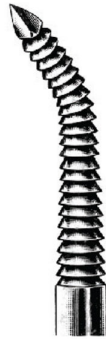

OI 22-6760-18



OI 22-6761-18



FOMON
OI 22-6762-21
21.0cm



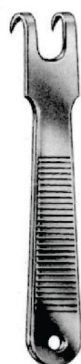

KILNER
OI 22-6763-10
10.0cm



CONVERSE
OI 22-6764-12
12.0cm



AUFRICHT
OI 22-6765-16
16.0cm



AUFRICHT
OI 22-6766-19
19.0cm



15.0cm



OI 22-6767-01



OI 22-6767-02



OI 22-6767-03



LANGE
OI 22-6768-22
22.0cm



FOMON
OI 22-6769-17
17.0cm



COTTLE
OI 22-6770-16
16.0cm



FREER
OI 22-6771-15
15.0cm



OGURA
 OI 22-6772-11
 11.0cm



COTTLE
 OI 22-6773-11
 11.0cm



COTTLE
 OI 22-6774-14
 14.0cm



COTTLE
 15.0cm

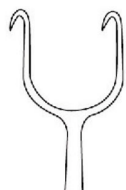

OI 22-6775-14

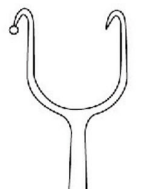

OI 22-6775-01



OI 22-6775-02



FOMON
 OI 22-6776-16
 16.0cm

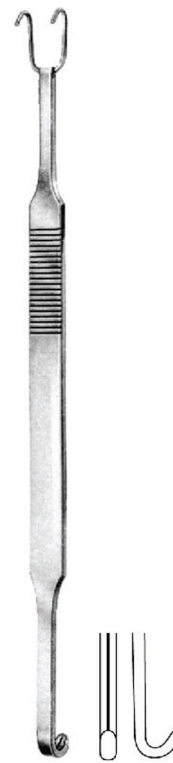
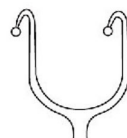

COTTLE-NEIVERT
 OI 22-6777-20
 20.0cm



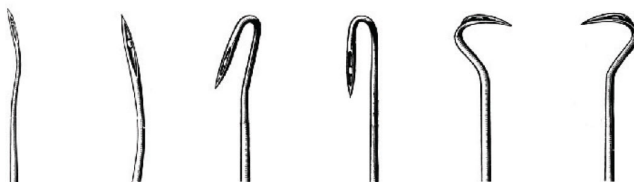

OI 22-6778-01 OI 22-6778-02 OI 22-6778-03 OI 22-6778-04 OI 22-6778-05



OI 22-6778-06 OI 22-6778-07 OI 22-6778-08 OI 22-6778-09



YANKAUER



COTTLE
OI 22-6779-14
14.0cm



NEIVERT
OI 22-6780-16
16.0cm



COTTLE
OI 22-6781-15
15.0cm



COTTLE
OI 22-6782-15
15.0cm



AUFRICHT
OI 22-6783-13
13.5cm



OI 22-6784-01 OI 22-6784-02 OI 22-6784-03

OI 22-6784-04 OI 22-6784-05 OI 22-6784-06

COAKLEY
 17.0cm

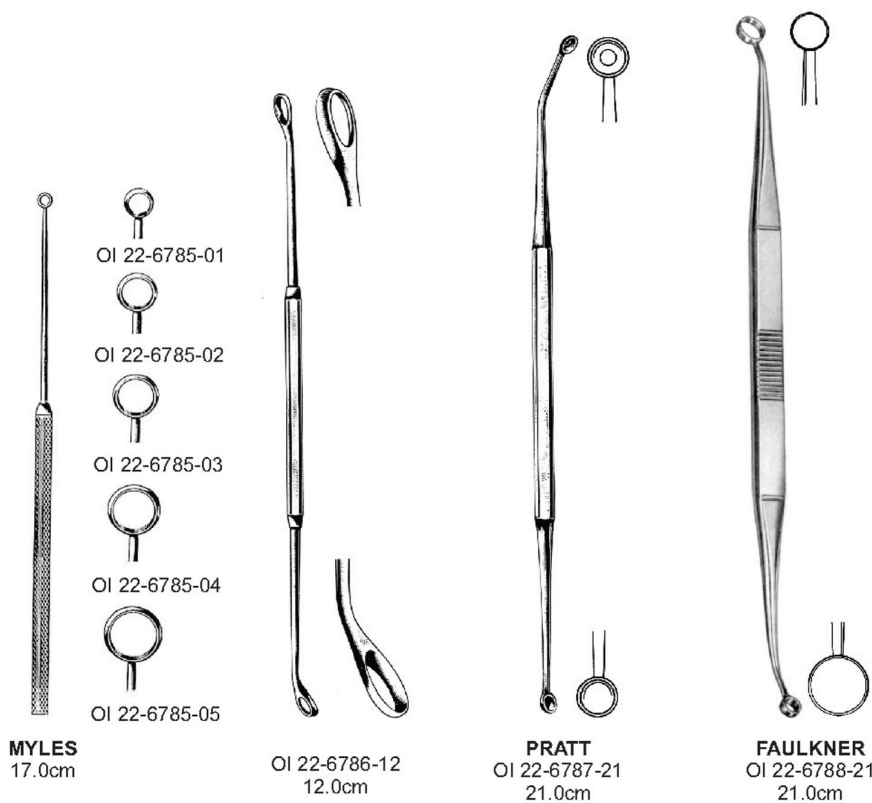

MYLES
 17.0cm

OI 22-6786-12
 12.0cm

PRATT
 OI 22-6787-21
 21.0cm

FAULKNER
 OI 22-6788-21
 21.0cm

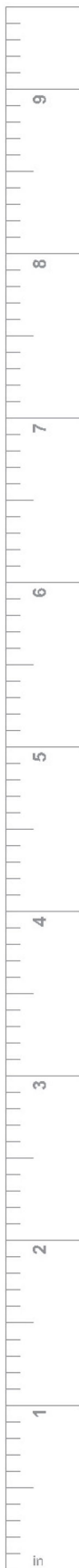



KRESSNER
OI 22-6789-20
20.0cm



ASCH
OI 22-6790-23
23.0cm



COTTLE-WALSHAM
23.0cm



OI 22-6791-23
straight



OI 22-6792-23
left



OI 22-6793-23
right



BECKMANN
22.0cm



BECKMANN
22.0cm



OI 22-6794-01
OI 22-6795-01



OI 22-6794-02
OI 22-6795-02

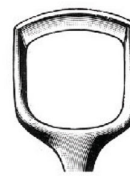

OI 22-6794-03
OI 22-6795-03



OI 22-6794-04
OI 22-6795-04



OI 22-6794-05
OI 22-6795-05



OI 22-6794-06
OI 22-6795-06



BECKMANN
22.0cm

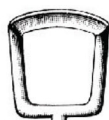

OI 22-6796-01

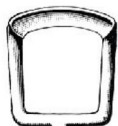

OI 22-6796-02

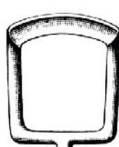

OI 22-6796-03

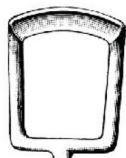

OI 22-6796-04

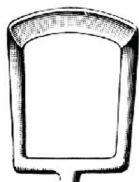

OI 22-6796-05



ST. CLAIR-THOMSON
21.0cm



OI 22-6797-08
8mm

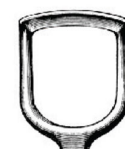

OI 22-6797-10
10mm



OI 22-6797-12
12mm

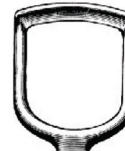

OI 22-6797-14
14mm

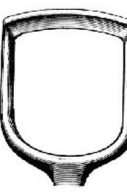

OI 22-6797-16
16mm

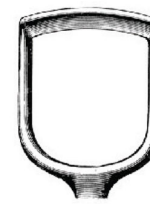

OI 22-6797-18
18mm





BRUENINGS-BRUNK
 OI 22-6798-21
 21.5cm

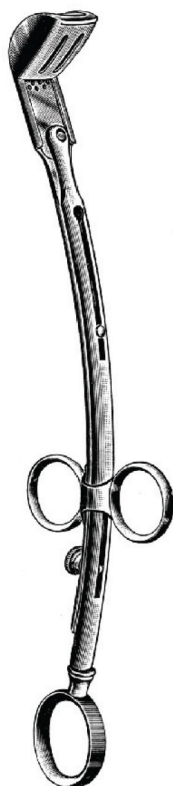

LA FORCE
 25.0cm



with unperforated blade
 OI 22-6799-01 Fig. 1
 OI 22-6799-02 Fig. 2
 OI 22-6799-03 Fig. 3

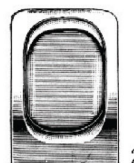

spare blades
 OI 22-6801-01 Fig. 1
 OI 22-6801-02 Fig. 2
 OI 22-6801-03 Fig. 3

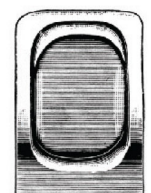

with perforated blade
 OI 22-6800-01
 OI 22-6800-02
 OI 22-6800-03

OI 22-6802-01
 OI 22-6802-02
 OI 22-6802-03

RHINOLOGY

